

Zijkant

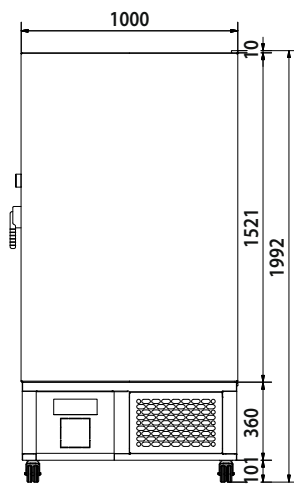

Voorkant

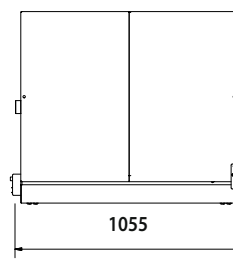

Bovenkant

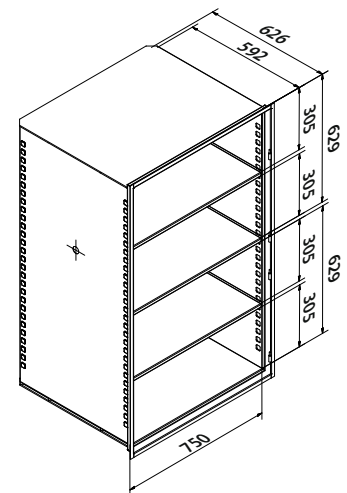

Binnenkant

**VRIEZER TYPE**

**VF620-86**

Inwendige afmetingen (lengte x diepte x hoogte)

750 x 626 x 1276 mm

Uitwendige afmetingen (lengte x diepte x hoogte)

1055 x 890 x 1992 mm

Minimale transport afmetingen (deuren, liften, hoeken)

1000 x 865 x 1982 mm

Netto gewicht

360 kg

## ACCESSOIRES INDEELSYSTEMEN

ALUMINIUM REKKEN (incl. lades met handgreep) t.b.v. 50 mm/2"doosjes.

artikel	comp. per vriezer	rekken totaal	lades per rek	doosjes per rek	doosjes totaal	max. hoogte doosje
DSA-5534-136G	4	20	5	20	400	53
DSA-11524-136G	2	10	11	44	440	52
DSA-11524-136G +	2	+			440	52
DSA-D211524-136G	4	22	22	88		

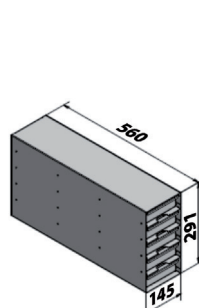

DSA-5534-136G

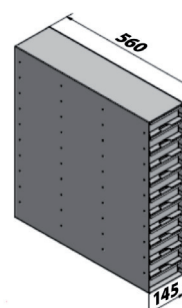

DSA-11524-136G

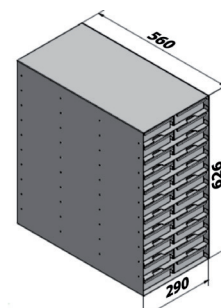

DSA-D211524-136G

ALUMINIUM REKKEN (incl. lades met handgreep) t.b.v. 75 mm/3"doosjes.

artikel	comp. per vriezer	rekken totaal	lades per rek	doosjes per rek	doosjes totaal	max. hoogte doosje
DSA-3914-136G	4	20	3	12	240	91
DSA-7844-136G	2	10	7	28	280	84
DSA-7844-136G +	2	+			280	84
DSA-D27844-136G	4	14	14	56		

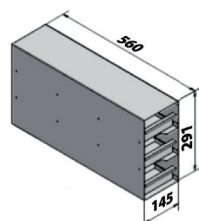

DSA-3914-136G

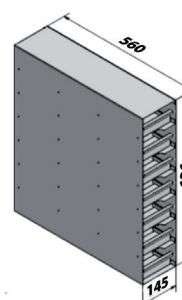

DSA-7844-136G

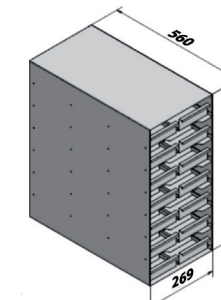

DSA-D27844-136G

RVS REKKEN (met handgrepen) t.b.v. 50 mm/2"doosjes en 75 mm/3" doosjes.

artikel	comp. per vriezer	rekken totaal	doosjes per rek	doosjes totaal	max. hoogte doosje
HR-4-5-53	4	20	20/2"	400/2"	53
HR-4-3-76	4	20	12/3"	240/3"	76

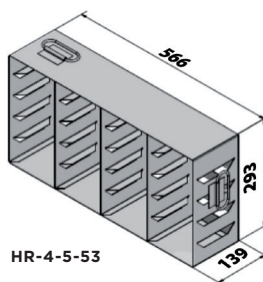

HR-4-5-53

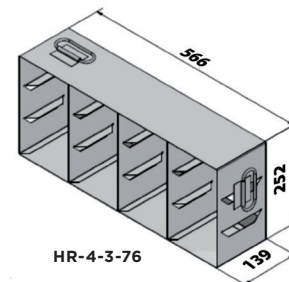

HR-4-3-76

\*Wijzigingen in specificaties voorbehouden.

## OPTIES

CO<sub>2</sub> BACK-UP SYSTEEM

Back-up koelsysteem.

## TEMPERATUUR SCHRIJVER

7-daags / 24 uren midi chart recorder incl. grafiek papier, pen tip en batterij.

## NOVO SMS-ALERT

NOVO stuurt een SMS-bericht naar de vooraf ingestelde mobiele nummers op het moment dat de vriezer een alarm geeft.

## BINNENDEURTJES

Vier (4) RVS geïsoleerde binnendeurtjes, optioneel afsluitbaar.

## IQ / OQ

Installatie en Operationele kwalificatie.

## SNIJDERS LABS

## Kantoor en Productie

Laurent Janssensstraat 105  
5048 AR Tilburg

## Showroom en Testfaciliteit

Gebroeders Salastraat 40  
5048 AL Tilburg

T 013 750 15 55

F 013 463 86 35

info@snijderslabs.com

[www.snijderslabs.com](http://www.snijderslabs.com)