

Zijkant

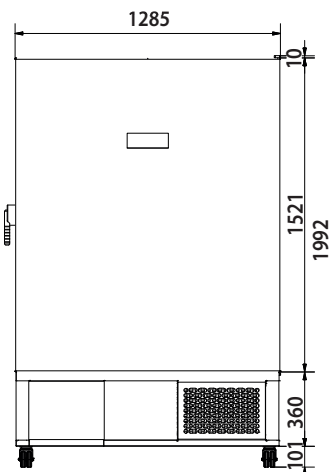

Voorkant

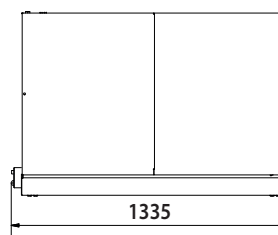

Bovenkant

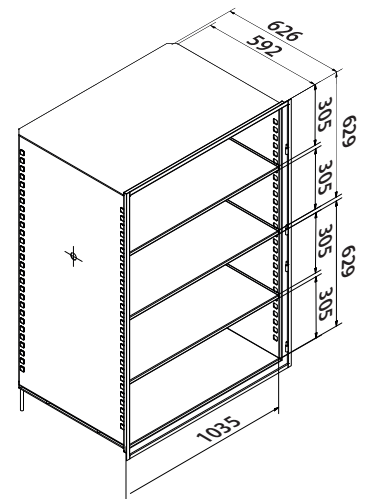

Binnenkant

VRIEZER TYPE

VF830-86

Inwendige afmetingen (lengte x diepte x hoogte)

1035 x 626 x 1276 mm

Uitwendige afmetingen (lengte x diepte x hoogte)

1335 x 890 x 1992 mm

Minimale transport afmetingen (deuren, liften, hoeken)

1285 x 865 x 1982 mm

Netto gewicht

390 kg

ACCESSOIRES INDEELSYSTEMEN

ALUMINIUM REKKEN (incl. lades met handgreep) t.b.v. 50 mm/2" doosjes.

artikel	comp. per vriezer	rekken totaal	lades per rek	doosjes per rek	doosjes totaal	max. hoogte doosje
DSA-5534-136G	4	28	5	20	560	53
DSA-11524-136G	2	14	11	44	616	52
DSA-11524-136G +	2	+			616	52
DSA-D211524-136G		6	22	88		

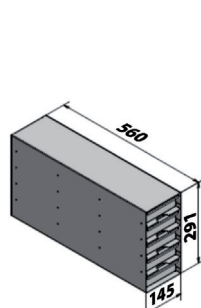

DSA-5534-136G

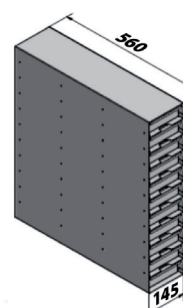

DSA-11524-136G

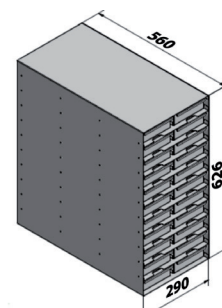

DSA-D211524-136G

ALUMINIUM REKKEN (incl. lades met handgreep) t.b.v. 75 mm/3" doosjes.

artikel	comp. per vriezer	rekken totaal	lades per rek	doosjes per rek	doosjes totaal	max. hoogte doosje
DSA-3914-136G	4	28	3	12	336	91
DSA-7844-136G	2	14	7	28	392	84
DSA-7844-136G +	2	+			392	84
DSA-D27844-136G		6	14	56		

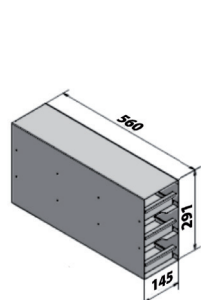

DSA-3914-136G

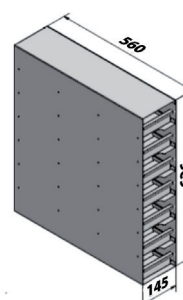

DSA-7844-136G

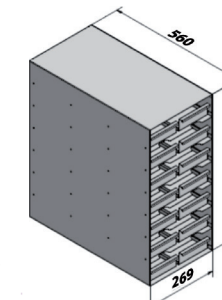

DSA-D27844-136G

RVS REKKEN (met handgrepen) t.b.v. 50 mm/2" doosjes en 75 mm/3" doosjes.

artikel	comp. per vriezer	rekken totaal	doosjes per rek	doosjes totaal	max. hoogte doosje
HR-4-5-53	4	28	20/2"	560/2"	53
HR-4-3-76	4	28	12/3"	336/3"	76

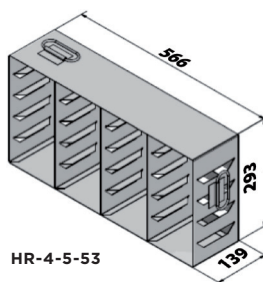

HR-4-5-53

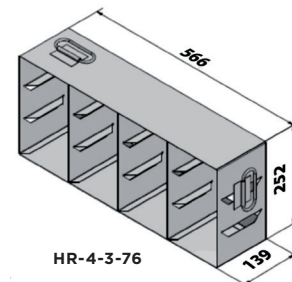

HR-4-3-76

*Wijzigingen in specificaties voorbehouden.

OPTIES

CO₂ BACK-UP SYSTEEM

Back-up koelsysteem.

TEMPERATUUR SCHRIJVER

7-daags / 24 uren midi chart recorder incl. grafiek papier, pen tip en batterij.

NOVO SMS-ALERT

NOVO stuurt een SMS-bericht naar de vooraf ingestelde mobiele nummers op het moment dat de vriezer een alarm geeft.

BINNENDEURTJES

Vier (4) RVS geïsoleerde binnendeurtjes, optioneel afsluitbaar.

IQ / OQ

Installatie en Operationele kwalificatie.

SNIJDERS LABS

Kantoor en Productie

Laurent Janssensstraat 105
5048 AR Tilburg

Showroom en Testfaciliteit

Gebroeders Salastraat 40
5048 AL Tilburg

T 013 750 15 55

F 013 463 86 35

info@snijderslabs.com

www.snijderslabs.com