

Zijkant

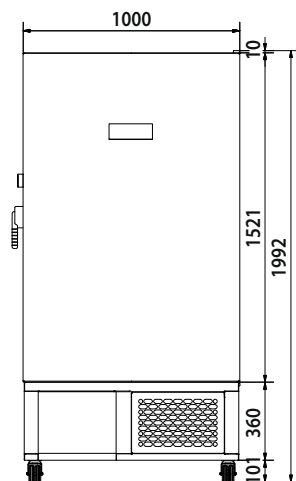

Voorkant

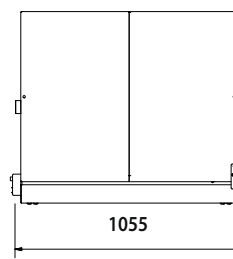

Bovenkant

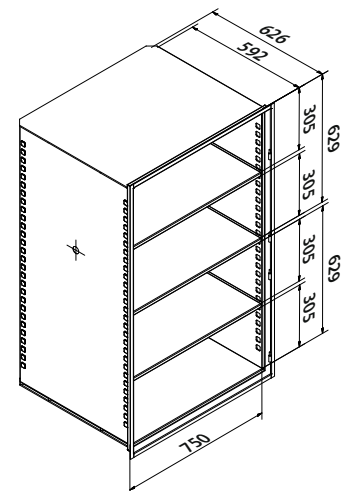

Binnenkant

## VRIEZER TYPE

## VF620-86

Inwendige afmetingen (lengte x diepte x hoogte)

750 x 626 x 1276 mm

Uitwendige afmetingen (lengte x diepte x hoogte)

1055 x 890 x 1992 mm

Minimale transport afmetingen (deuren, liften, hoeken)

1000 x 865 x 1982 mm

Netto gewicht

360 kg

## ACCESSOIRES INDEELSYSTEMEN

**ALUMINIUM REKKEN** (incl. lades met handgreep) t.b.v. 50 mm/2" doosjes.

| artikel             | comp. per vriezer | rekken totaal | lades per rek | doosjes per rek | doosjes totaal | max. hoogte doosje |
|---------------------|-------------------|---------------|---------------|-----------------|----------------|--------------------|
| DSA-5534-136G       | 4                 | 20            | 5             | 20              | 400            | 53                 |
| DSA-11524-136G      | 2                 | 10            | 11            | 44              | 440            | 52                 |
| DSA-11524-136G<br>+ | 2                 | +             |               |                 | 440            | 52                 |
| DSA-D211524-136G    | 4                 | 22            | 22            | 88              |                |                    |

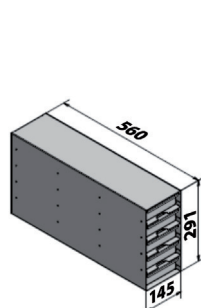

DSA-5534-136G

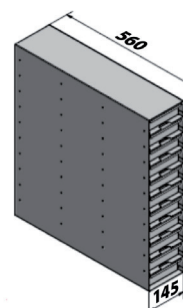

DSA-11524-136G

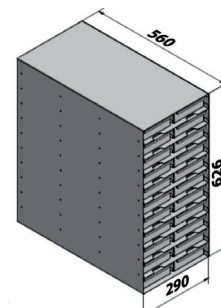

DSA-D211524-136G

**ALUMINIUM REKKEN** (incl. lades met handgreep) t.b.v. 75 mm/3" doosjes.

| artikel            | comp. per vriezer | rekken totaal | lades per rek | doosjes per rek | doosjes totaal | max. hoogte doosje |
|--------------------|-------------------|---------------|---------------|-----------------|----------------|--------------------|
| DSA-3914-136G      | 4                 | 20            | 3             | 12              | 240            | 91                 |
| DSA-7844-136G      | 2                 | 10            | 7             | 28              | 280            | 84                 |
| DSA-7844-136G<br>+ | 2                 | +             |               |                 | 280            | 84                 |
| DSA-D27844-136G    | 4                 | 14            | 14            | 56              |                |                    |

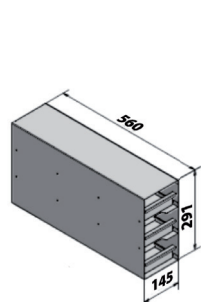

DSA-3914-136G

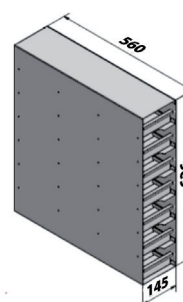

DSA-7844-136G

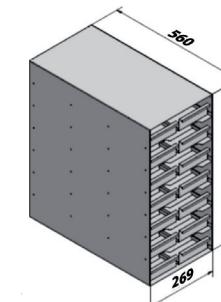

DSA-D27844-136G

**RVS REKKEN** (met handgrepen) t.b.v. 50 mm/2" doosjes en 75 mm/3" doosjes.

| artikel   | comp. per vriezer | rekken totaal | doosjes per rek | doosjes totaal | max. hoogte doosje |
|-----------|-------------------|---------------|-----------------|----------------|--------------------|
| HR-4-5-53 | 4                 | 20            | 20/2"           | 400/2"         | 53                 |
| HR-4-3-76 | 4                 | 20            | 12/3"           | 240/3"         | 76                 |

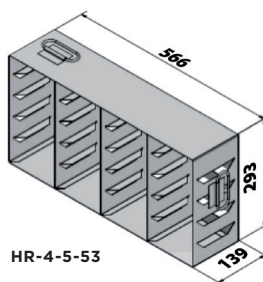

HR-4-5-53

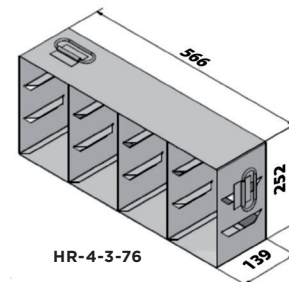

HR-4-3-76

\*Wijzigingen in specificaties voorbehouden.

## OPTIES

### CO<sub>2</sub> BACK-UP SYSTEEM

Back-up koelsysteem.

### TEMPERATUUR SCHRIJVER

7-daags / 24 uren midi chart recorder incl. grafiek papier, pen tip en batterij.

### NOVO SMS-ALERT

NOVO stuurt een SMS-bericht naar de vooraf ingestelde mobiele nummers op het moment dat de vriezer een alarm geeft.

### BINNENDEURTJES

Vier (4) RVS geïsoleerde binnendeurtjes, optioneel afsluitbaar.

### IQ / OQ

Installatie en Operationele kwalificatie.

## SNIJDERS LABS

### Kantoor en Productie

Laurent Janssensstraat 105  
5048 AR Tilburg

### Showroom en Testfaciliteit

Gebroeders Salastraat 40  
5048 AL Tilburg

T 013 750 15 55

F 013 463 86 35

info@snijderslabs.com

[www.snijderslabs.com](http://www.snijderslabs.com)

