

Zijkant

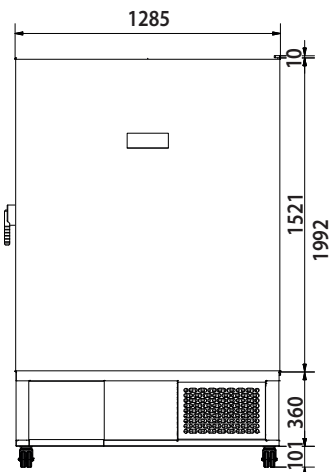

Voorkant

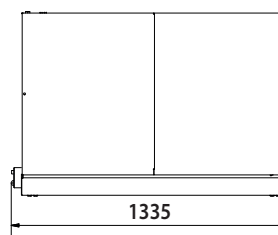

Bovenkant

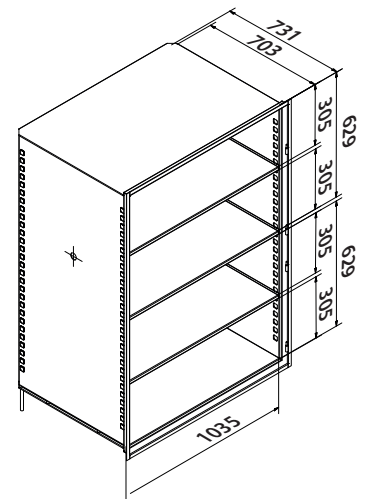

Binnenkant

**VRIEZER TYPE**

**VF1000-86**

Inwendige afmetingen (lengte x diepte x hoogte)

1035 x 731 x 1276 mm

Uitwendige afmetingen (lengte x diepte x hoogte)

1335 x 995 x 1992 mm

Minimale transport afmetingen (deuren, liften, hoeken)

1285 x 969 x 1982 mm

Netto gewicht

425 kg

## ACCESSOIRES INDEELSYSTEMEN

**ALUMINIUM REKKEN** (incl. lades met handgreep) t.b.v. 50 mm/2"doosjes.

artikel	comp. per vriezer	rekken totaal	lades per rek	doosjes per rek	doosjes totaal	max. hoogte doosje
DSA-5535-136G	4	28	5	25	700	53
DSA-11525-136G	2	14	11	55	770	52
DSA-11525-136G +	2	+			770	52
DSA-D211525-136G		6	22	110		

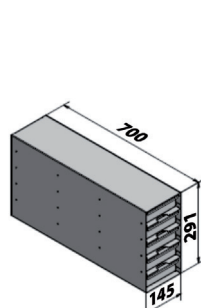

DSA-5535-136G

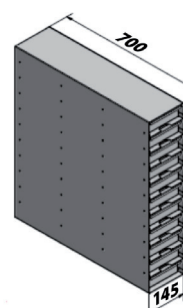

DSA-11525-136G

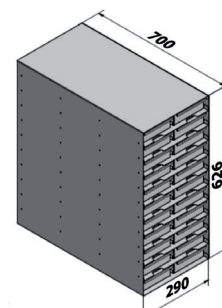

DSA-D211525-136G

**ALUMINIUM REKKEN** (incl. lades met handgreep) t.b.v. 75 mm/3"doosjes.

artikel	comp. per vriezer	rekken totaal	lades per rek	doosjes per rek	doosjes totaal	max. hoogte doosje
DSA-3915-136G	4	28	3	15	420	91
DSA-7845-136G	2	14	7	35	490	84
DSA-7845-136G +	2	+			490	84
DSA-D27845-136G		6	14	70		

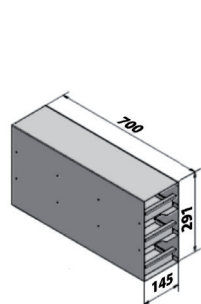

DSA-3915-136G

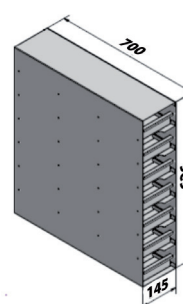

DSA-7845-136G

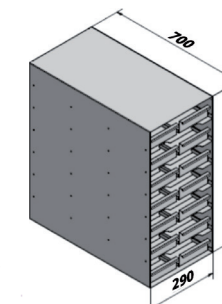

DSA-D27845-136G

**RVS REKKEN** (met handgrepen) t.b.v. 50 mm/2"doosjes en 75 mm/3" doosjes.

artikel	comp. per vriezer	rekken totaal	doosjes per rek	doosjes totaal	max. hoogte doosje
HR-5-5-53	4	28	25/2"	700/2"	53
HR-5-3-76	4	28	15/3"	420/3"	76

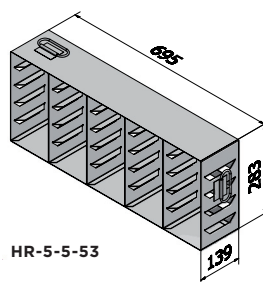

HR-5-5-53

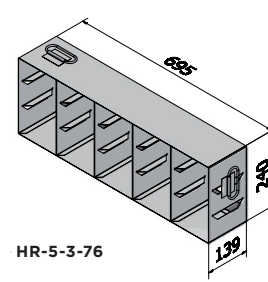

HR-5-3-76

\*Wijzigingen in specificaties voorbehouden.

## OPTIES

### CO<sub>2</sub> BACK-UP SYSTEEM

Back-up koelsysteem.

### TEMPERATUUR SCHRIJVER

7-daags / 24 uren midi chart recorder incl. grafiek papier, pen tip en batterij.

### NOVO SMS-ALERT

NOVO stuurt een SMS-bericht naar de vooraf ingestelde mobiele nummers op het moment dat de vriezer een alarm geeft.

### BINNENDEURTJES

Vier (4) RVS geïsoleerde binnendeurtjes, optioneel afsluitbaar.

### IQ / OQ

Installatie en Operationele kwalificatie.

## SNIJERS LABS

### Kantoor en Productie

Laurent Janssensstraat 105  
5048 AR Tilburg

### Showroom en Testfaciliteit

Gebroeders Salastraat 40  
5048 AL Tilburg

T 013 750 15 55

F 013 463 86 35

info@snijderslabs.com

[www.snijderslabs.com](http://www.snijderslabs.com)

