

Operating Manual

Translation of the original operating manual

KB / KB-UL (E4), KB / KB-UL (E6)

Cooling Incubators

with compressor technology and program control

Model	Model version	Art. No.
KB 53 (E4)	KB053-230V	9020-0199, 9120-0199
KB 53-UL (E4)	KB053UL-120V	9020-0302, 9120-0302
KB 115 (E4)	KB115-230V	9020-0397, 9120-0397
KB 115-UL (E4)	KB115UL-120V	9020-0398, 9120-0398
KB 240 (E6)	KB240-230V	9020-0202, 9120-0202
KB 240-UL (E6)	KB240UL-120V	9020-0304, 9120-0304
KB 400 (E6)	KB400-230V	9020-0203, 9120-0203
KB 400-UL (E6)	KB400UL-120V	9020-0305, 9120-0305
KB 720 (E6)	KB720-230V	9020-0204, 9120-0204
KB 720-UL (E6)	KB720UL-240V	9020-0306, 9120-0306

BINDER GmbH

- ▶ Address: Post office box 102, 78502 Tuttlingen, Germany ▶ Phone: +49 7462 2005 0
- ▶ Fax: +49 7462 2005 100 ▶ Internet: <http://www.binder-world.com>
- ▶ E-mail: info@binder-world.com ▶ Service Hotline: +49 7462 2005 555
- ▶ Service Fax: +49 7462 2005 93 555 ▶ Service E-Mail: service@binder-world.com
- ▶ Service Hotline USA: +1 866 885 9794 or +1 631 224 4340 x3
- ▶ Service Hotline Asia Pacific: +852 390 705 04 or +852 390 705 03
- ▶ Service Hotline Russia and CIS: +7 495 988 15 16

Contents

1. SAFETY	6
1.1 Legal considerations	6
1.2 Structure of the safety instructions.....	6
1.2.1 Signal word panel	6
1.2.2 Safety alert symbol	7
1.2.3 Pictograms	7
1.2.4 Word message panel structure.....	8
1.3 Localization / position of safety labels on the chamber	8
1.4 Type plate	9
1.5 General safety instructions on installing and operating the chambers	10
1.6 Intended use	12
1.7 Operating instructions	12
1.8 Measures to prevent accidents	13
2. CHAMBER DESCRIPTION	14
2.1 Chamber overview	15
2.2 Instrument panel	16
2.3 Lateral control panel with main power switch and optional equipment – KB / KB-UL 240 / 400 / 720 (E6).....	17
2.4 Chamber rear – KB / KB-UL 53 / 115 (E4).....	18
3. COMPLETENESS OF DELIVERY, TRANSPORTATION, STORAGE, AND INSTALLATION	19
3.1 Unpacking, and checking equipment and completeness of delivery	19
3.2 Guidelines for safe lifting and transportation.....	20
3.3 Storage.....	20
3.4 Location of installation and ambient conditions	21
4. INSTALLATION OF THE EQUIPMENT	22
4.1 Spacers for wall distance – KB / KB-UL 240 / 400 / 720 (E6).....	22
4.2 Mounting the flexible tilt protection kit.....	23
4.3 Electrical connection	24
5. START UP	25
6. FUNCTIONAL OVERVIEW OF THE T4.12 CHAMBER CONTROLLER	25
6.1 Menu structure	26
6.1.1 General menu	26
6.1.2 Quick menu	28
6.1.3 “User” menu	28
6.2 Operating modes.....	29
6.2.1 Activating the “control off” mode or change to “fixed value” operating mode	29
6.3 Performance during and after power failure.....	31
6.4 Information	32
7. CONFIGURATION OF OPTIONAL EQUIPMENT	33
7.1 Turning on / off the optional interior socket.....	33
7.2 Switching on or off the optional zero-voltage relay control outputs	34
7.3 Functional test of the optional alarm output	34
7.4 Switching on or off the optional object temperature display	35
7.5 RS 422 address (with optional RS 422 interface).....	35
8. SET-POINT ENTRY IN “FIXED VALUE” OPERATING MODE	36
8.1 Set-point ranges.....	36
8.2 Entering the set-points via “quick menu”.....	36
8.3 Entering the set-points via general menu	38

9.	TIME PROGRAMS	40
9.1	Starting and running an existing time program	42
9.2	Cancelling a running time program	45
9.3	Creating a new time program.....	46
9.3.1	Section handling	48
9.3.2	Temperature setpoint.....	49
9.3.3	Section duration	49
9.3.4	Repeating one or several sections within a time program.....	50
9.3.5	Tolerance range.....	51
9.3.6	Set-point ramp and set-point step modes.....	53
9.3.7	Switching on or off the optional zero-voltage relay outputs.....	55
9.3.8	Calling up the next parameter.....	56
9.3.9	Saving the time program and leaving the program editor.....	58
9.4	Program interruption	60
9.5	Deleting a time program.....	61
10.	WEEK PROGRAMS	62
10.1	Starting and running an existing week program	63
10.2	Cancelling a running week program	66
10.3	Creating a new week program	67
10.3.1	Section handling	69
10.3.2	Temperature setpoint.....	70
10.3.3	Day of the week	70
10.3.4	Time of the day	71
10.3.5	Activity of the shift-point.....	72
10.3.6	Switching on or off the optional zero-voltage relay outputs.....	72
10.3.7	Calling up the next parameter.....	73
10.3.8	Saving the week program and leaving the program editor.....	75
10.4	Deleting a week program	76
11.	KEY LOCK	77
11.1	Directly activating the key lock function	78
11.2	Automatic key lock	78
11.3	Changing the password for unlocking the key lock.....	80
12.	GENERAL CONTROLLER SETTINGS.....	81
12.1	Setup wizard	82
12.2	Date and time settings	82
12.3	Selecting the menu language of the T4.12 controller	84
12.4	Setting display brightness	84
12.5	Changing the temperature unit	85
12.6	Defining the data recording rate.....	85
12.7	Factory reset	86
12.8	Network configuration	86
12.9	Display of the entire network configuration	90
12.10	Display and entry of the chamber configuration – for service purpose.....	90
13.	DATA TRANSFER VIA USB INTERFACE	91
13.1	Exporting data to USB drive.....	91
13.2	Importing data from USB drive.....	92
14.	NOTIFICATIONS AND ALARMS.....	93
14.1	Notifications overview	93
14.2	Alarms overview.....	93
14.3	Alarm status	94
14.4	Confirming a “set” alarm.....	95
14.5	Alarm configuration and overview.....	96
14.5.1	List of active alarms	96
14.5.2	History – list of all alarms.....	97

14.5.3	Activating, deactivating, and testing the alarm buzzer	98
14.5.4	Activating / deactivating all alarm functions	98
15.	EVENT LIST	99
16.	GRAPHICAL DISPLAY OF THE MEASURED VALUES	100
16.1	Setting the sampling rate	100
16.2	Defining the display range.....	101
16.3	Selecting the parameters	102
17.	TEMPERATURE SAFETY DEVICES.....	103
17.1	Over temperature protective device (class 1)	103
17.2	Overtemperature safety controller (temperature safety device class 3.1)	103
17.2.1	Safety controller modes	103
17.2.2	Setting the safety controller	104
17.3	Over- and undertemperature safety controller (temperature safety device class 3.3) (option)	107
17.3.1	Safety controller modes	107
17.3.2	Setting the Over- and undertemperature safety controller	108
18.	DEFROSTING DURING REFRIGERATING OPERATION	111
19.	OPTIONS.....	112
19.1	Communication software APT-COM™ 3 DataControlSystem (option).....	112
19.2	RS RS 422 interface (option)	112
19.3	Data logger kit (option).....	112
19.4	Object temperature display with flexible Pt 100 temperature sensor (option)	113
19.5	Zero-voltage relay alarm output (may be available via BINDER INDIVIDUAL Customized Solutions).....	113
19.6	Analog output for temperature (option).....	115
19.7	Zero-voltage relay control outputs (may be available via BINDER INDIVIDUAL Customized Solution)	115
19.8	Water protected internal socket (option).....	116
19.9	Interior lighting.....	116
20.	MAINTENANCE, CLEANING, AND SERVICE	117
20.1	Maintenance intervals, service.....	117
20.2	Cleaning and decontamination	118
20.2.1	Cleaning.....	118
20.2.2	Decontamination	119
20.3	Sending the chamber back to BINDER GmbH	120
21.	DISPOSAL	121
21.1	Disposal of the transport packing.....	121
21.2	Decommissioning.....	121
21.3	Disposal of the chamber in the Federal Republic of Germany	121
21.4	Disposal of the chamber in the member states of the EU except for the Federal Republic of Germany.....	123
21.5	Disposal of the chamber in non-member states of the EU	124
22.	TROUBLESHOOTING	125
23.	TECHNICAL DESCRIPTION.....	127
23.1	Factory calibration and adjustment	127
23.2	Over current protection	127
23.3	Definition of usable volume	128
23.4	Technical data.....	129
23.5	Equipment and Options (extract)	131
23.6	Spare parts and accessories (extract)	132
23.7	KB / KB-UL 53 dimensions.....	133
23.8	KB / KB-UL 115 dimensions.....	134
23.9	KB / KB-UL 240 dimensions.....	135



23.10 KB / KB-UL 400 dimensions.....	136
23.11 KB / KB-UL 720 dimensions.....	137
24. CERTIFICATES AND DECLARATIONS OF CONFORMITY.....	138
24.1 EU Declaration of Conformity.....	138
24.2 Certificate for the GS mark of conformity of the “Deutsche Gesetzliche Unfallversicherung e.V.“ (German Social Accident Insurance) DGUV.....	141
25. PRODUCT REGISTRATION.....	143
26. CONTAMINATION CLEARANCE CERTIFICATE.....	144
26.1 For chambers located outside USA and Canada.....	144
26.2 For chambers in USA and Canada.....	147

Dear customer,

For the correct operation of the chambers, it is important that you read this operating manual completely and carefully and observe all instructions as indicated. Observe the national regulations on minimum age of laboratory personnel. Failure to read, understand and follow the instructions may result in personal injury. It can also lead to damage to the chamber and/or poor equipment performance.

1. Safety

This operating manual is part of the components of delivery. Always keep it handy for reference. The device should only be operated by laboratory personnel especially trained for this purpose and familiar with all precautionary measures required for working in a laboratory. To avoid injuries and damage observe the safety instructions of the operating manual.

	 WARNING
<p>Failure to observe the safety instructions. Serious injuries and chamber damage.</p> <ul style="list-style-type: none"> ➤ Observe the safety instructions in this operating manual. ➤ Carefully read the complete operating instructions of the chambers. 	

1.1 Legal considerations

This operating manual is for informational purposes only. It contains information for installing, start-up, operation and maintenance of the product. Note: the contents and the product described are subject to change without notice.

Understanding and observing the instructions in this operating manual are prerequisites for hazard-free use and safety during operation and maintenance. In no event shall BINDER be held liable for any damages, direct or incidental arising out of or related to the use of this manual.

This operating manual cannot cover all conceivable applications. If you would like additional information, or if special problems arise that are not sufficiently addressed in this manual, please ask your dealer or contact us directly by phone at the number located on page one of this manual

Furthermore, we emphasize that the contents of this operating manual are not part of an earlier or existing agreement, description, or legal relationship, nor do they modify such a relationship. All obligations on the part of BINDER derive from the respective purchase contract, which also contains the entire and exclusively valid statement of warranty administration. The statements in this manual neither augment nor restrict the contractual warranty provisions.

1.2 Structure of the safety instructions

In this operating manual, the following safety definitions and symbols indicate dangerous situations following the harmonization of ISO 3864-2 and ANSI Z535.6.

1.2.1 Signal word panel

Depending on the probability of serious consequences, potential dangers are identified with a signal word, the corresponding safety color, and if appropriate, the safety alert symbol.

 DANGER
<p>Indicates an imminently hazardous situation that, if not avoided, will result in death or serious (irreversible) injury.</p>

WARNING

Indicates a potentially hazardous situation which, if not avoided, could result in death or serious (irreversible) injury.

CAUTION

Indicates a potentially hazardous situation which, if not avoided, may result in moderate or minor (reversible) injury.

CAUTION

Indicates a potentially hazardous situation which, if not avoided, may result in damage to the product and/or its functions or of a property in its proximity.

1.2.2 Safety alert symbol







Use of the safety alert symbol indicates a **risk of injury**.

Observe all measures that are marked with the safety alert symbol in order to avoid death or injury.

1.2.3 Pictograms

Warning signs			
Electrical hazard	Hot surface	Explosive atmosphere	Stability hazard
Lifting hazard	Risk of corrosion and / or chemical burns	Harmful substances	Biohazard
Pollution Hazard			
Mandatory action signs			
Mandatory regulation	Read operating instructions	Disconnect the power plug	Lift with several persons
Lift with mechanical assistance	Environment protection	Wear protective gloves	Wear safety goggles

Prohibition signs			
 Do NOT touch	 Do NOT spray with water	 Do NOT climb	

	Information to be observed in order to ensure optimum function of the product.
---	---



1.2.4 Word message panel structure

<p>Type / cause of hazard.</p> <p>Possible consequences.</p> <p>⊘ Instruction how to avoid the hazard: prohibition</p> <p>➤ Instruction how to avoid the hazard: mandatory action</p>

Observe all other notes and information not necessarily emphasized in the same way, in order to avoid disruptions that could result in direct or indirect injury or property damage.

1.3 Localization / position of safety labels on the chamber

The following labels are located on the chamber:

Pictograms (Warning signs)	
	Hot surface <ul style="list-style-type: none"> • Inner glass door above the glass door handle
	Read operating manual <ul style="list-style-type: none"> • UL chambers: outer chamber door • Chamber with optional interior socket: below the interior socket
Service label	
	

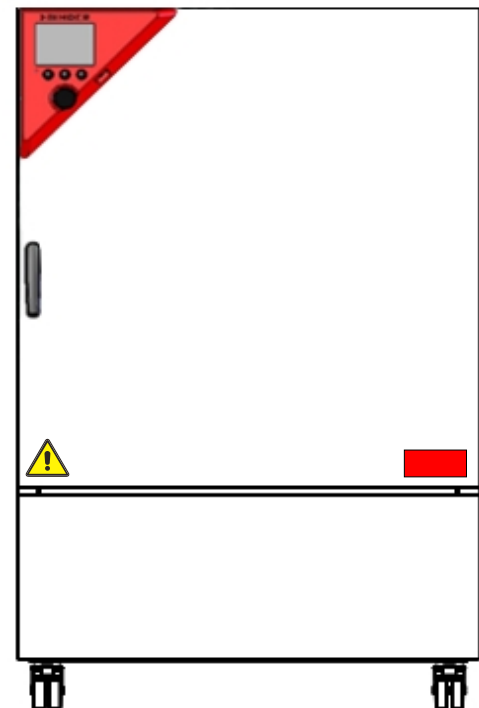



Figure 1: Position of labels on the chamber (example KB 240-UL)

	Keep safety labels complete and legible.
---	---

Replace safety labels that are no longer legible. Contact BINDER Service for these replacements.

1.4 Type plate

The type plate sticks to the left side of the chamber, bottom right-hand.







Nominal temp.	100 °C 212 °F	1,20 kW / 5,2 A 200-230 V / 50 Hz	    	Max. operating pressure 15 bar R 134A – 0,35 kg Contains fluorinated greenhouse gases covered by the Kyoto Protocol
IP protection	20	200-230 V / 60 Hz		
Safety device	DIN 12880	1 N ~		
Class	3.1			
Art. No.	9020-0202			
Project No.		Cooling incubator		
Built	2017			
		BINDER GmbH Im Mittleren Ösch 5 78532 Tuttlingen / Germany www.binder-world.com	KB 240 E6	 Serial No. 00000000000000 Made in Germany

Figure 2: Type plate (example of KB 240 regular chamber)

Nominal temp.	100 °C 212 °F	1,20 kW / 5,2 A 200-230 V / 50 Hz	    	Max. operating pressure 15 bar R 134A – 0,35 kg Contains fluorinated greenhouse gases covered by the Kyoto Protocol With option internal socket: Nominal power: 1,70 kW
IP protection	20	200-230 V / 60 Hz		
Safety device	DIN 12880	1 N ~		
Class	3.1			
Art. No.	9120-0202			
Project No.		Cooling incubator		
Built	2017			
		BINDER GmbH Im Mittleren Ösch 5 78532 Tuttlingen / Germany www.binder-world.com	KB 240 E6	 Serial No. 00000000000000 Made in Germany

Figure 3: Type plate (example of KB 240 optional chamber)

Indications of the type plate (example)		Information
BINDER		Manufacturer: BINDER GmbH
KB 240		Model designation
Cooling incubator		Device name
Serial No.	00000000000000	Serial no. of the chamber
Built	2017	Year of construction
Nominal temperature	100 °C 212 °F	Nominal temperature
IP protection	20	IP type of protection acc. to standard EN 60529
Temp. safety device	DIN 12880	Temperature safety device acc. to standard DIN 12880:2007
Class	3.1	Class of temperature safety device
Art. No.	9020-0202	Art. no. of the chamber
Project No.	---	Optional: Special application acc. to project no.
1,20 kW		Nominal power
5,2 A		Nominal current
200-230 V / 50 Hz		Nominal voltage range +/-10% at the indicated power frequency
200-230 V / 60 Hz		
1 N ~		Current type
Max. operating pressure 15 bar		Max. operating pressure in the refrigerating system
R 134A - 0,35 kg		Refrigerant type and max. filling weight
Contains fluorinated greenhouse gases covered by the Kyoto Protocol		Contains fluorinated greenhouse gases covered by the Kyoto Protocol
With option internal socket: Nominal power: 1,70 kW		With option internal socket: increased total nominal power

Symbol on the type plate	Information
	CE conformity marking
	Electrical and electronic equipment manufactured / placed on the market in the EU after 13 August 2005 and to be disposed of in separate collection according to Directive 2012/19/EU on waste electrical and electronic equipment (WEEE).
	GS mark of conformity of the "Deutsche Gesetzliche Unfallversicherung e.V. (DGUV), Prüf- und Zertifizierungsstelle Nahrungsmittel und Verpackung im DGUV Test" (German Social Accident Insurance (DGUV), Testing and Certification Body for Foodstuffs and Packaging Industry in DGUV Test).
	The chamber is certified according to Customs Union Technical Regulation (CU TR) for the Eurasian Economic Union (Russia, Belarus, Armenia, Kazakhstan Kyrgyzstan).
 (KB-UL only)	The chamber is certified by Underwriters Laboratories Inc.® according to the following standards: <ul style="list-style-type: none"> • UL 61010-1, 3rd Edition, 2012-05, Rev. 2015-07 • CAN/CSA-C22.2 No. 61010-1, 3rd Edition, 2012-05, Rev. 2015-07 • IEC/EN 61010-1:2014, 3rd Edition

1.5 General safety instructions on installing and operating the chambers



With regard to operating the chambers and to the installation location, please observe the DGUV guidelines 213-850 on safe working in laboratories (formerly BGI/GUV-I 850-0, BGR/GUV-R 120 or ZH 1/119, issued by the employers' liability insurance association) (for Germany).

BINDER GmbH is only responsible for the safety features of the chamber provided skilled electricians or qualified personnel authorized by BINDER perform all maintenance and repair, and if components relating to chamber safety are replaced in the event of failure with original spare parts.



To operate the chamber, use only original BINDER accessories or accessories from third-party suppliers authorized by BINDER. The user is responsible for any risk caused by using unauthorized accessories.

	CAUTION
	<p>Danger of overheating. Damage to the chamber.</p> <ul style="list-style-type: none"> ⊘ Do NOT install the chamber in unventilated recesses. ➤ Ensure sufficient ventilation for dispersal of the heat.

Do not operate the chambers in hazardous locations.



	 DANGER
	<p>Explosion hazard. Danger of death.</p> <ul style="list-style-type: none"> ⊘ Do NOT operate the chamber in potentially explosive areas. ➤ KEEP explosive dust or air-solvent mixtures AWAY from the chamber.

The chambers do not dispose of any measures of explosion protection.

	 DANGER
	<p>Explosion hazard. Danger of death.</p> <ul style="list-style-type: none"> ∅ Do NOT introduce any substance into the cooling incubator which is combustible or explosive at working temperature. ∅ NO explosive dust or air-solvent mixture in the inner chamber.



Any solvent contained in the charging material must not be explosive or inflammable. I.e., irrespective of the solvent concentration in the steam room, NO explosive mixture with air must form. The temperature inside the chamber must lie below the flash point or below the sublimation point of the charging material. Familiarize yourself with the physical and chemical properties of the charging material, as well as the contained moisture constituent and its behavior with the addition of heat energy.



Familiarize yourself with any potential health risks caused by the charging material, the contained moisture constituent or by reaction products which may arise during the temperature process. Take adequate measures to exclude such risks prior to putting the cooling incubator into operation.

	 DANGER
	<p>Electrical hazard. Danger of death.</p> <ul style="list-style-type: none"> ∅ The chamber must NOT become wet during operation or maintenance.

The cooling incubators were produced in accordance with VDE regulations and were routinely tested in accordance to VDE 0411-1 (IEC 61010-1).

During and shortly after operation, the temperature of the inner surfaces almost equals the set-point.

	 CAUTION
	<p>The glass doors, the glass door handles, and the inner chamber will become hot during operation.</p> <p>Danger of burning.</p> <ul style="list-style-type: none"> ∅ Do NOT touch the glass doors, the glass door handles, the inner surfaces or the charging material during operation.

 	 WARNING
	<p>Stability hazard. Danger of injury. Damage to the chamber and the charging material. Housing cover breakaway.</p> <ul style="list-style-type: none"> ∅ Do NOT climb on the lower housing cover. ∅ Do NOT load the lower housing cover or the door with heavy objects while the chamber door is open.

1.6 Intended use



Cooling incubators KB / KB-UL are suitable for exact conditioning of harmless materials. Because of their precise temperature accuracy these devices are especially useful for cultivation of microorganisms with a narrow temperature optimum in a range of 4 °C / 39.2°F to 37 °C / 98.6°F. Main fields of application are tests of long-term storage (e.g. at 4 °C / 39.2°F), refrigerated incubation between 20 °C / 68°F and 25 °C / 77°F and incubation at 37 °C / 98.6°F (also with additional introduction of heat) or with alternating temperatures (e.g. 37 °C / 98.6°F and 4 °C / 39.2°F).

A mixture of any component of the charging material with air must NOT be explosive. The operating temperature must lie below the flash point or below the sublimation point of the charging material. Any component of the charging material must NOT be able to release toxic gases.

Other applications are not approved.

The chambers are not classified as medical devices as defined by the Medical Device Directive 93/42/EEC.

	Following the instructions in this operating manual and conducting regular maintenance work (chap. 20.1) are part of the intended use.
---	--

 	 DANGER
<p>Explosion or implosion hazard. Danger of poisoning. Danger of death.</p> <ul style="list-style-type: none"> ∅ Do NOT introduce any substance combustible or explosive at working temperature into the chamber, in particular no energy sources such as batteries or lithium-ion batteries. ∅ NO explosive dust or air-solvent mixture in the inner chamber. ∅ Do NOT introduce any substance which could lead to release of toxic gases. 	

	The charging material shall not contain any corrosive ingredients that may damage the machine components made of stainless steel, aluminum, and copper. Such ingredients include in particular acids and halides. Any corrosive damage caused by such ingredients is excluded from liability by BINDER GmbH.
---	--

	WARNING: If customer should use a BINDER chamber running in non-supervised continuous operation, we strongly recommend in case of inclusion of irrecoverable specimen or samples to split such specimen or samples and store them in at least two chambers, if this is feasible.
---	---

In case of foreseeable use of the chamber there is no risk for the user through the integration of the chamber into systems or by special environmental or operating conditions in the sense of EN 61010-1:2010. For this, the intended use of the chamber and all its connections must be observed.

1.7 Operating instructions

Depending on the application and location of the chamber, the operator of the chamber must provide the relevant information for safe operation of the chamber in a set of operating instructions.

	Keep these operating instructions with the chamber at all times in a place where they are clearly visible. They must be comprehensible and written in the language of the employees.
---	--

1.8 Measures to prevent accidents

The operator of the chamber must observe the following rule: “Betreiben von Arbeitsmitteln. Betreiben von Kälteanlagen, Wärmepumpen und Kühleinrichtungen“ (Operation of work equipment. Operation of refrigeration systems, heat pumps and refrigeration equipment) (GUV-R 500 chap. 2.35) (for Germany).

The manufacturer took the following measures to prevent ignition and explosions:

- **Indications on the type plate**

See operating manual chap. 1.4.

- **Operating manual**

An operating manual is available for each chamber.

- **Overtemperature monitoring**

The chamber is equipped with a temperature display, which can be read from outside.

The chamber is equipped with an additional safety controller (temperature safety device class 3.1 acc. to DIN 12880:2007). Visual and audible (buzzer) signals indicate temperature exceeding.

- **Safety, measurement, and control equipment**

The safety, measuring, and control equipment is easily accessible.

- **Electrostatic charge**

The interior parts are grounded.

- **Non-ionizing radiation**

Non-ionizing radiation is not intentionally produced, but released only for technical reasons by electrical equipment (e.g. electric motors, power cables, solenoids). The machine has no permanent magnets. If persons with active implants (e.g. pacemakers, defibrillators) keep a safe distance (distance of field source to implant) of 30 cm, an influence of these implants can be excluded with high probability.

- **Protection against touchable surfaces**

Tested according to EN ISO 13732-1:2008.

- **Floors**

See operating manual chap. 3.4 for correct installation

- **Cleaning**

See operating manual chap. 20.2.

- **Examinations**

The chamber has been inspected by the “Deutsche Gesetzliche Unfallversicherung e.V. (DGUV) (German Social Accident Insurance (DGUV)” (German Social Accident Insurance (DGUV), Testing and Certification Body for Foodstuffs and Packaging Industry in DGUV Test) and bears the GS mark.

2. Chamber description

A high level of precision, reliability, and safety for all growth parameters ensures optimum incubation conditions. Moreover, the KB / KB-UL cooling incubator is designed for maximum usability – even in continuous operation year after year. It fulfills all technical and application-specific requirements arising in experimentation such as in the areas of biotechnology, medicine, the nutrition industry, pharmaceutical and cosmetics industries, botany, and zoology.

Two important temperature technologies have been combined to achieve perfect temperature control. The specially developed DCT™ refrigerating system, a direct refrigerating process, in conjunction with the APT.line™ preheating chamber technology, satisfies the unique prerequisites for attaining highly-precise temperature control and particularly short recovery times after opening the door.

The refrigerating system is distinguished by direct, precise, and rapid temperature conduction. Large-area labyrinth evaporator plates directly conduct the cold to the atmosphere of the working space.

The APT.line™ preheating chamber system ensures high level of spatial and time-based temperature precision, thanks to the direct and distributed air circulation into the interior. This is especially important for maintaining temperatures – especially with full chambers – and for rapid restoration of optimum growth conditions after opening the door. The inner glass door ensures that the temperature remains constant when observing the incubation process. The fan supports exact attainment and maintenance of the desired temperature accuracy. The fan speed is digitally adjustable. The heating and refrigerating systems are microprocessor regulated to a tenth of a degree. In addition, the chamber provides almost unlimited possibilities for adaptation to individual customer requirements based upon extensive programming options and on the week program timer and real time clock of the controller.

The KB / KB-UL 240 / 400 / 720 (E6) chambers are equipped with a door heating.

All chamber functions are easy and comfortable to use thanks to their clear arrangement. Major features are easy cleaning of all chamber parts and avoidance of undesired contamination.

The inner chamber, the pre-heating chamber and the interior side of the doors are all made of stainless steel V2A (German material no. 1.4301, US equivalent AISI 304). The housing is RAL 7035 powder-coated. All corners and edges are also completely coated.

The chamber comes equipped with an Ethernet interface for computer communication, e.g. via the communication software APT-COM™ 3 DataControlSystem (option, chap. 19.1). For further options, see chap. 23.5.

The KB / KB-UL 240 / 400 / 720 (E6) chambers are equipped with four castors. Both front castors can easily be locked via the attached brakes.

Temperature range at ambient temperature of 25 °C / 77 °F: -5 °C / 23 °F up to +100 °C / 212 °F

2.1 Chamber overview

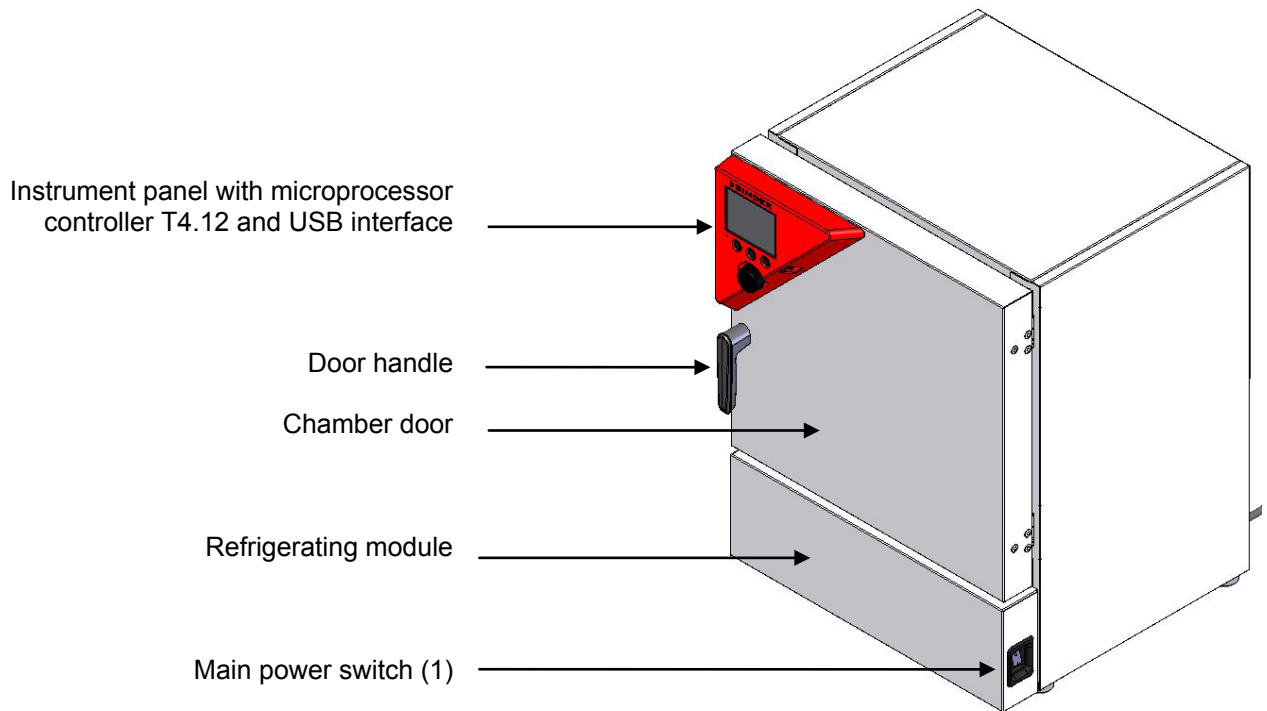

Figure 4: Cooling incubator KB / KB-UL 53 / 115 (E4)

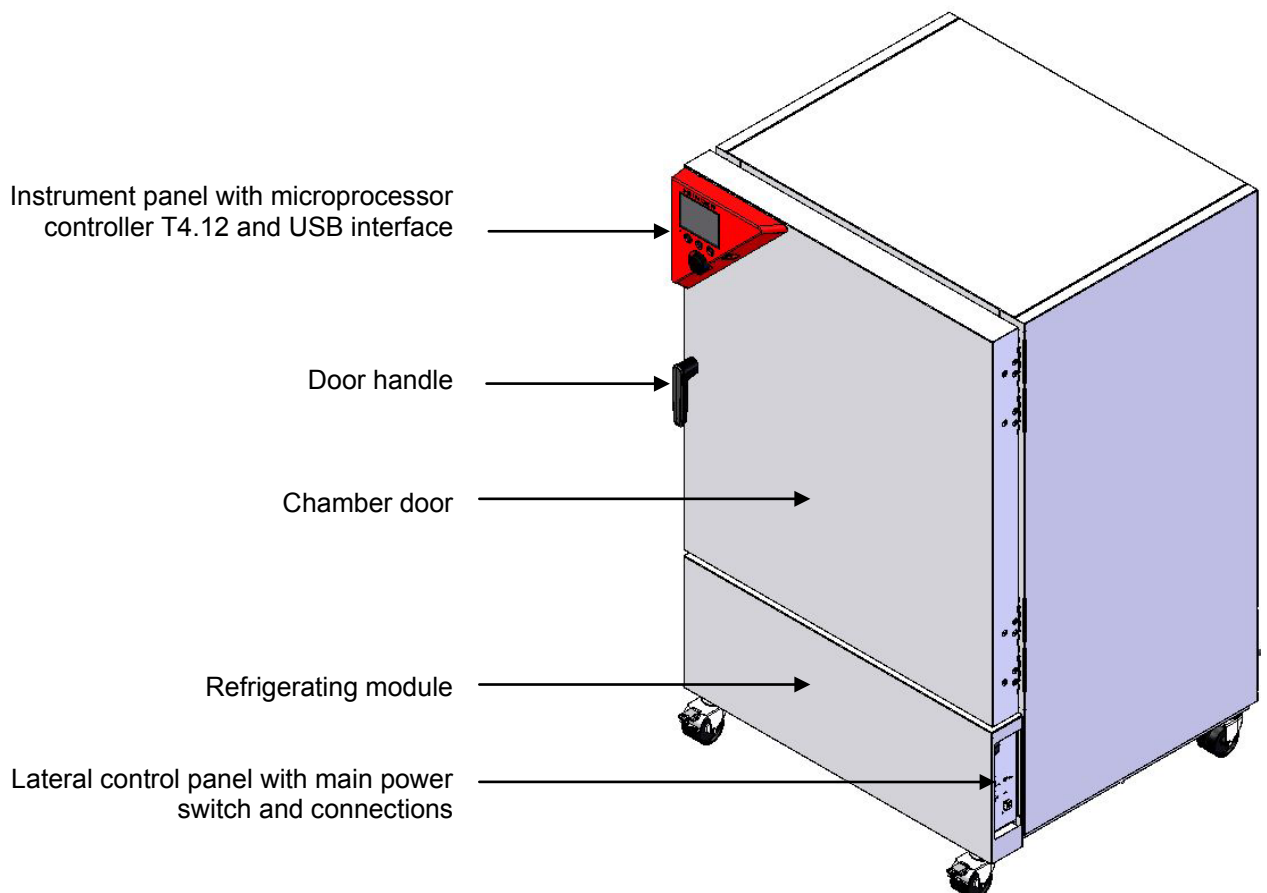

Figure 5: Cooling incubator KB / KB-UL 240 / 400 / 720 (E6)

2.2 Instrument panel

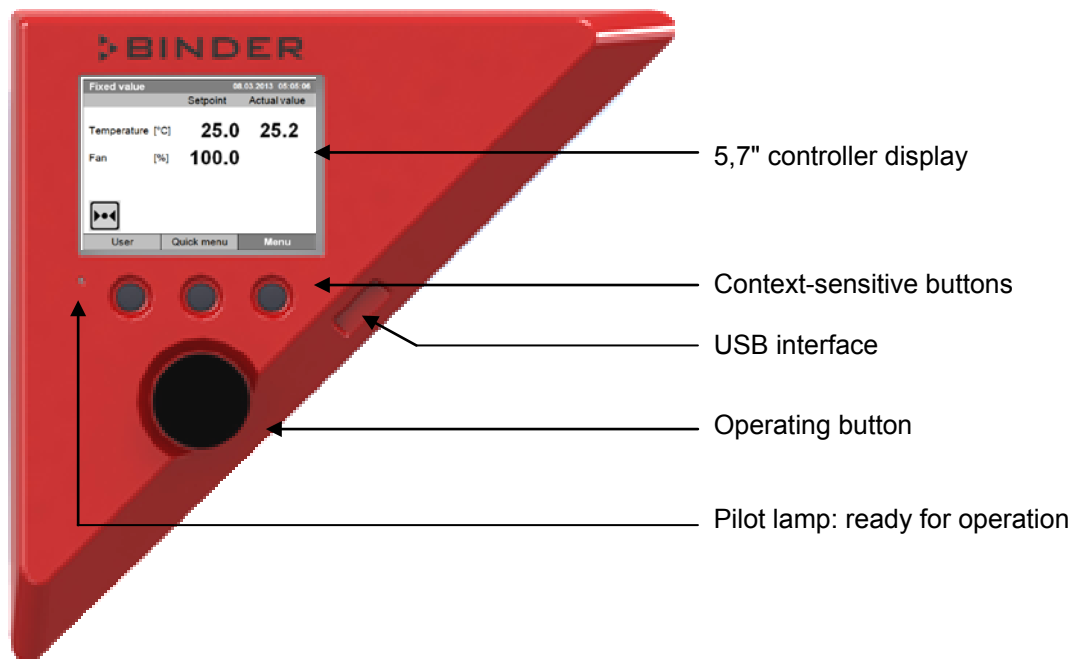

Figure 6: Instrument panel with microprocessor controller T4.12 and USB interface

2.3 Lateral control panel with main power switch and optional equipment – KB / KB-UL 240 / 400 / 720 (E6)

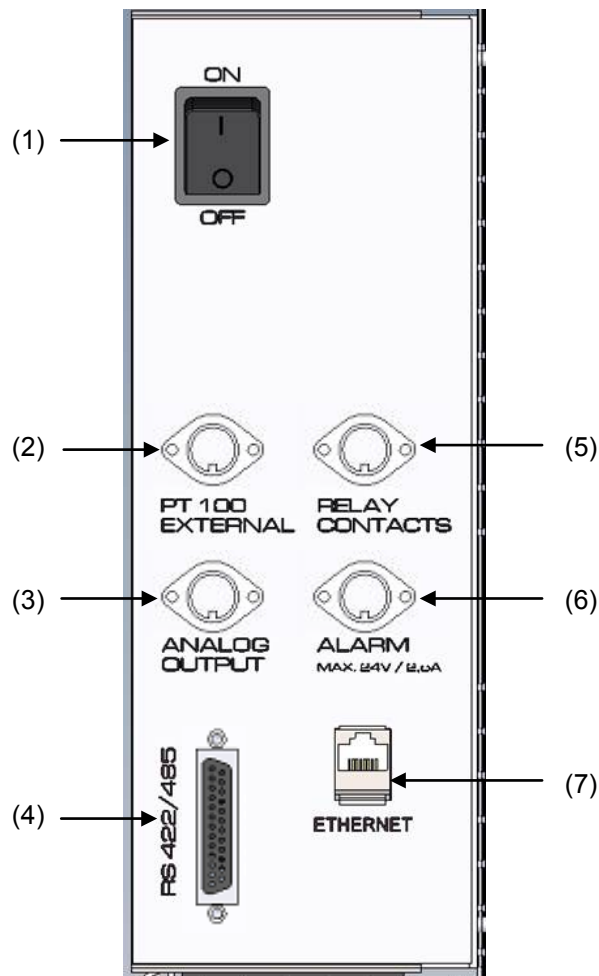

Figure 7: Lateral control panel at the right side of the refrigerating machine, with options

- (1) Main power switch
- (2) DIN-socket for additional Pt 100 temperature sensor (may be available via BINDER INDIVIDUAL Customized Solutions)
- (3) DIN socket for analog output 4-20 mA (option)
- (4) RS422 interface (option)
- (5) DIN-socket for zero-voltage relay control outputs (may be available via BINDER INDIVIDUAL Customized Solutions)
- (6) DIN-socket for zero-voltage relay alarm output (option)
- (7) Ethernet interface for computer communication

2.4 Chamber rear – KB / KB-UL 53 / 115 (E4)

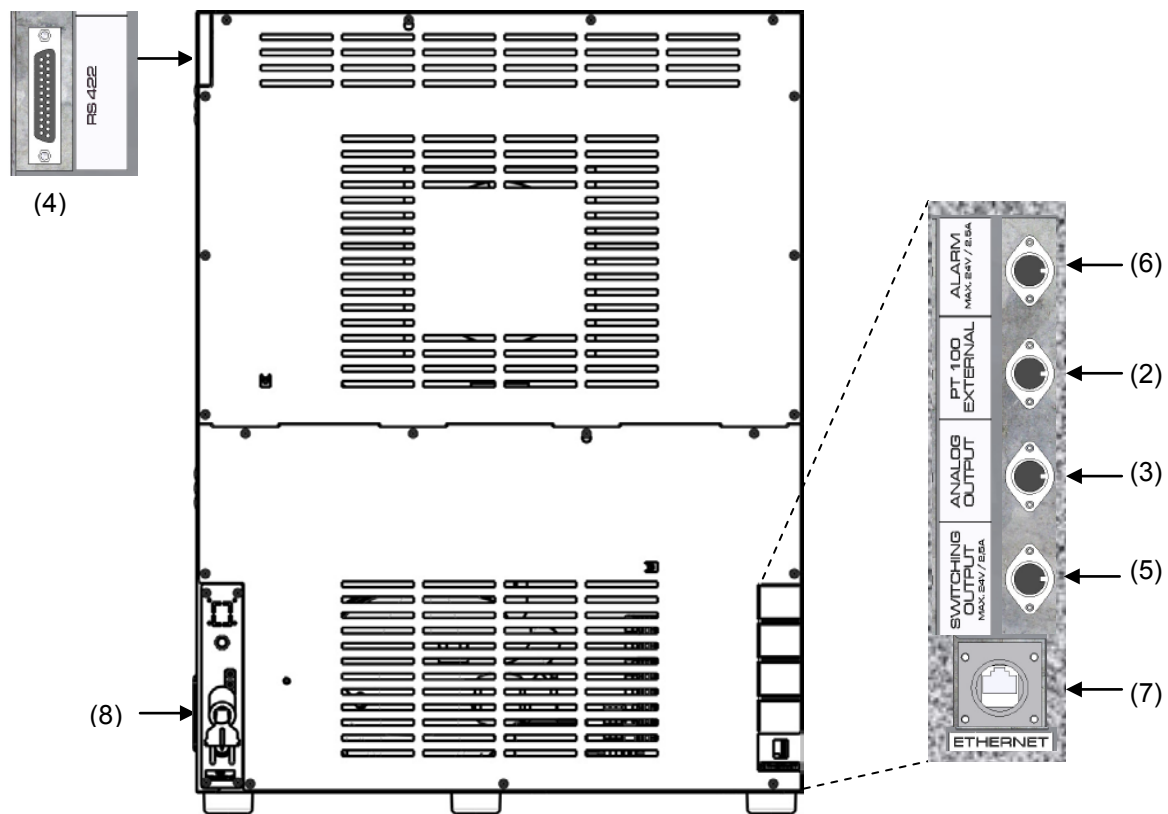

Figure 8: Chamber rear with position of options (example)

- (2) DIN-socket for additional Pt 100 temperature sensor (may be available via BINDER INDIVIDUAL Customized Solutions)
- (3) DIN socket for analog output 4-20 mA (option)
- (4) RS422 interface (option)
- (5) DIN-socket for zero-voltage relay control outputs (may be available via BINDER INDIVIDUAL Customized Solutions)
- (6) DIN-socket for zero-voltage relay alarm output (option)
- (7) Ethernet interface for computer communication
- (8) Power cable





3. Completeness of delivery, transportation, storage, and installation

3.1 Unpacking, and checking equipment and completeness of delivery

After unpacking, please check the chamber and its optional accessories, if any, based on the delivery receipt for completeness and for transportation damage. Inform the carrier immediately if transportation damage has occurred.

The final tests of the manufacturer may have caused traces of the shelves on the inner surfaces. This has no impact on the function and performance of the chamber.

Please remove any transportation protection devices and adhesives in/on the chamber and on the doors and remove the operating manuals and accessory equipment.

   	 CAUTION
<p>Sliding or tilting of the chamber. Damage to the chamber. Risk of injury by lifting heavy loads.</p> <ul style="list-style-type: none"> Ø Do NOT lift or transport the chamber using the door, the handle, or the lower housing. Ø Do NOT lift KB / KB-UL 400 / 720 by hand. ➤ Lift KB / KB-UL 53 / 115 from the pallet with the aid of four people in the area of all 4 chamber feet. ➤ Lift KB / KB-UL 240 from the pallet with the aid of six people in the area of all 4 chamber feet or use a fork lifter. Set the fork lifter only from the front or rear in the middle of the chamber. ➤ Lift KB / KB-UL 400 / 720 using technical devices (fork lifter) from the pallet. Set the fork lifter only from the front or rear in the middle of the chamber. Ø Do NOT set the fork lifter from the chamber side. 	

If you need to return the chamber, please use the original packing and observe the guidelines for safe lifting and transportation (chap. 3.2).

For disposal of the transport packing, see chap. 21.1.





Note on second-hand chambers (Ex-Demo-Units):

Second-hand chambers are chambers that were used for a short time for tests or exhibitions. They are thoroughly tested before resale. BINDER ensures that the chamber is technically sound and will work flawlessly.

Second-hand chambers are marked with a sticker on the chamber door. Please remove the sticker before commissioning the chamber.

3.2 Guidelines for safe lifting and transportation

The front castors of KB / KB-UL 240 / 400 / 720 can be blocked by brakes. Please move the chambers with castors only when empty and on an even surface, otherwise the castors may be damaged. After operation, please observe the guidelines for temporarily decommissioning the chamber (chap. 21.2).

 CAUTION	
   	<p>Sliding or tilting of the chamber. Damage to the chamber. Risk of injury by lifting heavy loads.</p> <ul style="list-style-type: none"> ➤ Transport the chamber in its original packaging only. ➤ For moving or shipping, secure the chamber with transport straps. ⊘ Do NOT lift or transport the chamber using the door, the handle, or the lower housing. ⊘ Do NOT lift KB / KB-UL 400 / 720 by hand. ➤ Lift KB / KB-UL 53 / 115 with the aid of four people in the area of all 4 chamber feet. ➤ Lift KB / KB-UL 240 with the aid of 6 people or with a fork lifter. Set the fork lifter only from the front or rear in the middle of the chamber. ➤ Lift KB / KB-UL 400 / 720 using technical devices (fork lifter). Set the fork lifter only from the front or rear in the middle of the chamber. ⊘ Do NOT set the fork lifter from the chamber side.

- Permissible ambient temperature range during transport: -10 °C / 14°F to +60 °C / 140°F.

You can order transport packing for moving or shipping purposes from BINDER service.

3.3 Storage

Intermediate storage of the chamber is possible in a closed and dry room. Observe the guidelines for temporary decommissioning (chap. 21.2).

- Permissible ambient temperature range during storage: -10 °C / 14°F to +60 °C / 140°F.
- Permissible ambient humidity: max. 70 % r.H., non-condensing

When after storage in a cold location you transfer the chamber to its warmer installation site, condensation may form. Before start-up, wait at least one hour until the chamber has attained ambient temperature and is completely dry.

3.4 Location of installation and ambient conditions

Set up the chamber on a flat, even surface, free from vibration, in a well-ventilated, dry location and align it using a spirit level. The site of installation must be capable of supporting the chamber's weight (see technical data, chap. 23.4). The chambers are designed for setting up inside a building (indoor use).

	CAUTION
	<p>Danger of overheating. Damage to the chamber.</p> <ul style="list-style-type: none"> ⊘ Do NOT set up chambers in non-ventilated recesses. ➤ Ensure sufficient ventilation for dispersal of the heat.

- Permissible ambient temperature range during operation: +18 °C / 64.4 °F to +32 °C / 89.6 °F. At elevated ambient temperature values, fluctuations in temperature can occur.

	<p>The ambient temperature should not be substantially higher than the indicated ambient temperature of +22 °C +/- 3 °C / 71.6 °F +/- 5.4 °F to which the specified technical data relates. Deviations from the indicated data are possible for other ambient conditions.</p>
---	---

	<p>With each degree of ambient temperature > +25 °C / 77°F, the refrigeration power decreases by 1.5 K.</p>
---	--

- Permissible ambient humidity: 70 % r.H. max., non-condensing.

When operating the chamber at temperature set-points below ambient temperature, high ambient humidity may lead to condensation on the chamber.

- Installation height: max. 2000 m / 6562 ft. above sea level.

When placing several chambers of the same size side by side, maintain a minimum distance of 250 mm / 9.84 in between each chamber. Wall distances: rear 100 mm / 3.94 in, sides 160 mm / 6.29 in. Spacing above the chamber of at least 100 mm / 3.94 in must also be maintained.

Two KB / KB-UL 53 / 115 (E4) chambers of the same size can be piled on top of each other. For this purpose place rubber pads under every foot of the upper chamber to prevent the device from slipping.

	CAUTION
	<p>Sliding or tilting of the upper chamber. Damage to the chambers.</p> <ul style="list-style-type: none"> ➤ When stacking, place rubber pads under every foot of the upper chamber. ➤ Stack only chambers of the same size.

KB / KB-UL 240 / 400 / 720 (E6) chambers must NOT be stacked.

	CAUTION
	<p>Danger by stacking. Damage to the chambers.</p> <ul style="list-style-type: none"> ⊘ Do NOT place the cooling incubators on top of each other.



To completely separate the chamber from the power supply, you must disconnect the power plug. Install the chamber in a way that the power plug is easily accessible and can be easily pulled in case of danger.

For the user there is no risk of temporary overvoltages in the sense of EN 61010-1:2010.

With an increased amount of dust in the ambient air, clean the condenser fan (by suction or blowing) several times a year.

Avoid any conductive dust in the ambience according to the chamber layout complying with pollution degree 2 (IEC 61010-1).

Do not install or operate the chamber in potentially explosive areas.

	 DANGER
	<p>Explosion hazard. Danger of death.</p> <ul style="list-style-type: none">⊘ Do NOT operate the chamber in potentially explosive areas.➤ KEEP explosive dust or air-solvent mixtures AWAY from the vicinity of the chamber.

4. Installation of the equipment

4.1 Spacers for wall distance – KB / KB-UL 240 / 400 / 720 (E6)

Please fix both spacers with the supplied screws at the chamber rear. This serves to ensure the prescribed minimum distance to the wall of 100 mm / 3.94 in.



Figure 9: Spacer for rear wall distance

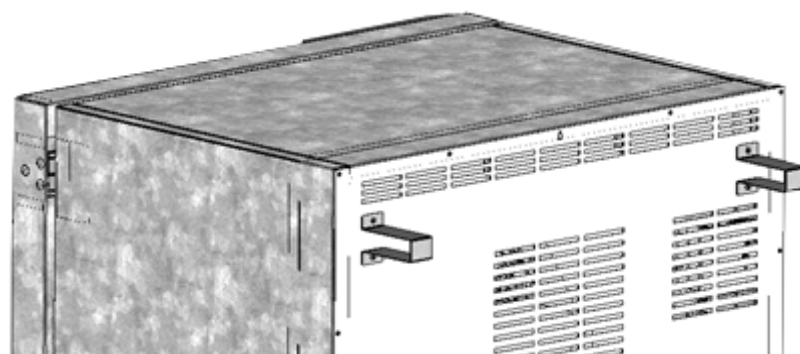



Figure 10: Rear KB / KB-UL 240 / 400 / 720 (E6) with mounted spacers

4.2 Mounting the flexible tilt protection kit

Use the supplied flexible tilt protection kit in addition to the spacers for wall distance (chap. 4.1). This will prevent the chamber from tilting when the door is open.

	CAUTION
	<p>Sliding or tilting of the chamber. Damage to the chamber.</p> <p>➤ Fix the chamber to a wall with supplied flexible tilt protection kit</p>

Scope of delivery:

- 4 Torx screws (spare parts)
- 4 tilt protection holders
- 4 securing straps (2 spare parts)

Mounting on device side:

- Remove two screws on the upper part of the rear wall (a)
- Fix two of the supplied tilt protection holders, each centrally with one of these screws (b).

Mounting on wall side

- Fix two of the supplied tilt protection holders in the appropriate distance, each with two screws Ø 6mm suitable for the wall (c)

Connection with the securing straps

- On each side, thread one of the supplied securing straps through the provided slots of a device side and a wall side tilt protection holder

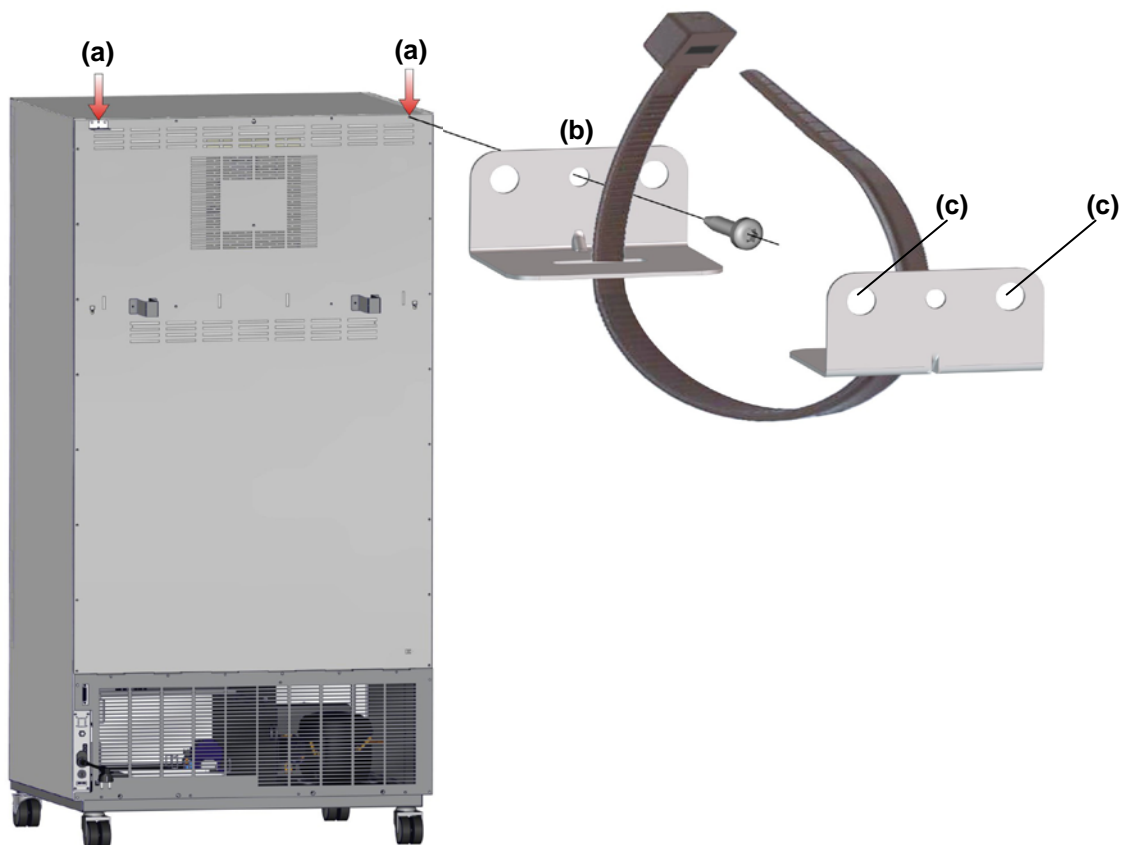



Figure 11: Rear chamber (example KB 400) and mounting the flexible tilt protection kit

4.3 Electrical connection

The chambers are supplied ready for connection. They come with a fixed power connection cable that has a length of at least 1800 mm / 5.9 ft and are protected with a chamber-protection against over current, the chambers KB 53-UL / KB 115-UL in addition with an internal fuse.

Model	Power plug	Nominal voltage +/- 10% at the indicated power frequency	Current type	Chamber fuse
KB 53 (E4) KB 115 (E4)	Shock-proof plug	230 V at 50 Hz	1N~	10 A
KB 240 (E6) KB 400 (E6) KB 720 (E6)	Shock-proof plug	200-230 V at 50 Hz 200-230 V at 60 Hz	1N~	16 A
KB 53-UL (E4) KB 115-UL (E4)	NEMA 5-15	115 V at 60 Hz	1N~	12,5 A
KB 240-UL (E6) KB 400-UL (E6)	NEMA 5-20P	100-120 V at 50 Hz 100-120 V at 60 Hz	1N~	16 A
KB 720-UL (E6)	NEMA 6-20P	200-240 V at 50 Hz 200-240 V at 60 Hz	2 ~	16 A

- The domestic socket must also provide a protective conductor. Make sure that the connection of the protective conductor of the domestic installations to the chamber's protective conductor meets the latest technology. The protective conductors of the socket and plug must be compatible!
- Prior to connection and start-up, check the power supply voltage. Compare the values to the specified data located on the chamber's type plate (left chamber side, bottom right-hand, see chap. 1.4).
- When connecting, please observe the regulations specified by the local electricity supply company as well as the VDE directives (for Germany). We recommend the use of a residual current circuit breaker.
- Pollution degree (acc. to IEC 61010-1): 2
- Over-voltage category (acc. to IEC 61010-1): II

	CAUTION
	<p>Danger of incorrect power supply voltage. Damage to the equipment.</p> <ul style="list-style-type: none"> ➤ Check the power supply voltage before connection and start-up. ➤ Compare the power supply voltage with the data indicated on the type plate.

See also electrical data (chap. 23.4).

	<p>To completely separate the chamber from the power supply, you must disconnect the power plug. Install the chamber in a way that the power plug is easily accessible and can be easily pulled in case of danger.</p>
---	--

5. Start up

After connecting the electrical supply (chap. 4.1), turn on the chamber by the main power switch (1). The pilot lamp shows the chamber is ready for operation.

	Observe a delay time of about 30s between turning Off and On again. Otherwise an initialization problem may occur.
---	--

Note that the chamber is in stand-by mode when the main power switch has been turned on and yet the controller display is dark. Turn on the chamber by pressing any controller button.

Warming chambers may release odors in the first few days after commissioning. This is not a quality defect. To reduce odors quickly we recommend heating up the chamber to its nominal temperature for one day and in a well-ventilated location.

	WARNING: If customer should use a BINDER chamber running in non-supervised continuous operation, we strongly recommend in case of inclusion of irrecoverable specimen or samples to split such specimen or samples and store them in at least two chambers, if this is feasible.
---	---

6. Functional overview of the T4.12 chamber controller

The T4.12 chamber controller controls the temperature (range: -5 °C / 23 °F up to +100 °C / 212 °F) and the fan speed (range: 40 % up to 100 %) inside the chamber. You can enter the desired set point values in fixed value operating mode or in program mode in the display controller. The controller also offers a week program function and various notifications and alarm messages with visual and audible indication, a trace file and remote alarms via e-mail. You can enter values or programs directly at the controller keypad or using the APT-COM™ 3 DataControlSystem software (option, chap. 19.1) specially developed by BINDER.

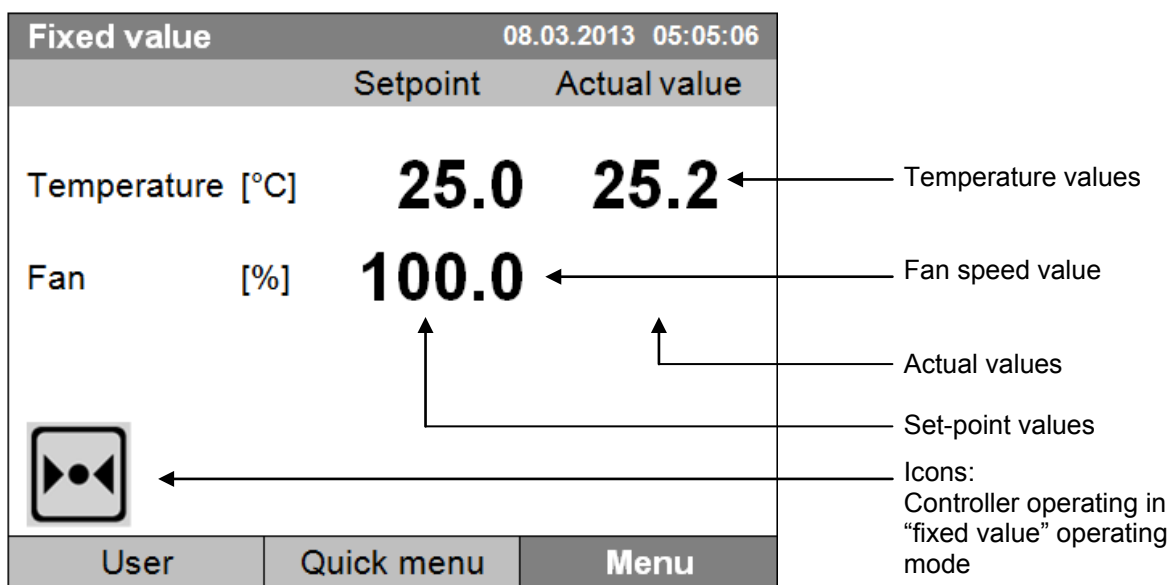



Figure 12: T4.12 microprocessor controller, initial view in "fixed value" controller mode (sample values)

6.1 Menu structure

Fixed value		08.03.2015 05:05:06	
	Setpoint	Actual value	
Temperature [°C]	25.0	25.2	
Fan [%]	100.0		
			
User		Quick menu	
		Menu	

Initial view (sample values).
Press the desired menu button.

From the Initial view you have access to different menus using the menu buttons "User", "Quick menu", or "Menu". From there you can access the desired control functions. To do this, select the function by turning the operating button and press the operating button to confirm the selection.

In any menu, you can return to the previous display pressing the "Close" button or to the initial view with the "Home" button.

Depending on the logged-in user or administrator, the available menu functions may vary. These instructions present the functions which are available to the logged-in administrator.

6.1.1 General menu

The general menu provides access to all setting functions of the controller, a graphical display of the measured values, and the possibility to read and give out data via the USB interface. In addition, supporting functions like a settings wizard or a contact page are available.

Fixed value		08.03.2015 05:05:06	
..\ Menu			
Controller mode			
Event list			
Alarms			
Setpoints			
Safety controller			
Programs			
Import/Export			
Settings 			
Close		Home	

General menu

Turn the operating button to see additional menu items.

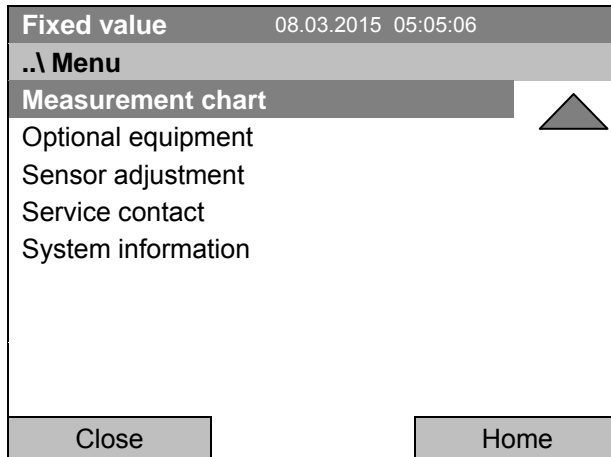

General menu (next page)
 ("Optional equipment" menu item is visible only with optional chamber equipment)

Controller mode	Switching between the operating modes "control off" or "fixed value", chap. 6.2.1
Event list	Display of status information and errors, chap. 15
Alarms	Alarm settings, chap. 14.5
Setpoints	Setpoint entry in "Fixed value" operating mode, chap. 8
Safety controller	Setting the safety controller, chap. 17.2 and 17.3
Programs	Time and week programs, chap. 9 and 10
Import/Export	Data transfer via USB interface, chap. 13
Settings	General controller settings, chap. 12
Measurement chart	Graphical display of the measured values, chap. 16
Optional equipment	Setting for optional equipment like interior socket, zero-voltage relay control outputs, alarm output, object temperature display, chap. 7 (menu item is visible only with optional chamber equipment)
Sensor adjustment	Adjustment menu for single-point and two-point adjustments (for Service purpose)
Service contact	Service information
System information	Chamber information (model, name, serial no., firmware etc.)

6.1.2 Quick menu

The Quick menu provides fast access to frequently used functions.

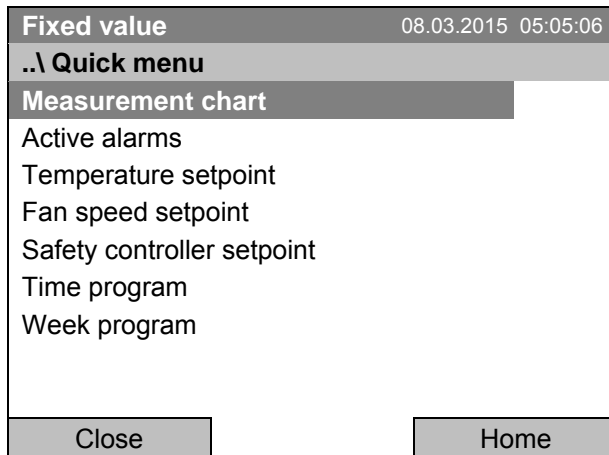

“Quick menu”

Measurement chart	Graphical display of the measured values, chap. 16
Active alarms	Alarm settings, chap. 14.5
Temperature setpoint	Temperature setpoint entry in “Fixed value” operating mode, chap. 8
Fan speed setpoint	Fan speed setpoint entry in “Fixed value” operating mode, chap. 8
Safety controller setpoint	Setting the safety controller setpoint, chap. 17.2 and 17.3
Time program	Starting and cancelling a time program, chap. 9.1, 9.2
Week program	Starting and cancelling a week program, chap. 10.1, 10.2

6.1.3 “User” menu

The user menu includes the key lock function and provides quick access to the event list. The key lock function serves to block the access to the controller. An overview of logon, logoff, and other events is given in the event list.

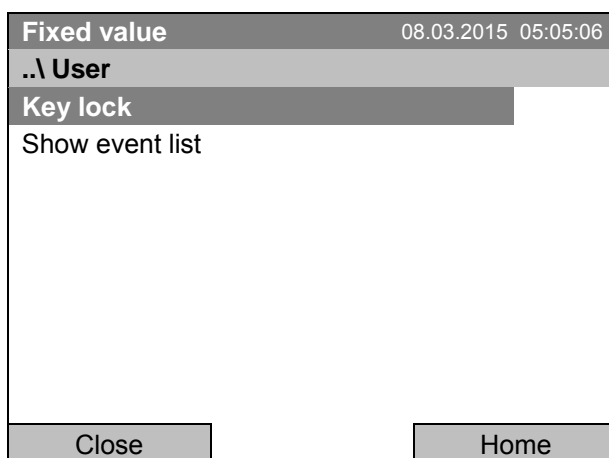

“User” menu

Key lock	Configuring the key lock function, chap. 11
Show event list	Displaying the event list, chap. 15

6.2 Operating modes

In the “**control off**” mode (chap. 6.2.1), the controller is non-functional and displays only the actual values. There is no heating or refrigeration. The temperature approximates the ambient value, the fan turns with 40 % speed.

You can enter the desired set point values in “**fixed value**” mode (chap. 8). The controller then operates as a fixed-point control, i.e., it reaches and maintains the defined temperature set-point until the next manual change.

The T4.12 program controller also permits running a **time program** (chap. 9) or a **week program** (chap. 10). You can program temperature cycles and define also the fan speed for each program section. The controller offers 52 time program places with up to 100 sections each. The week program mode offers 8 week program places with up to 30 shift points for each week program.

6.2.1 Activating the “control off” mode or change to “fixed value” operating mode

To select the “control off” or “fixed value” operating mode, go to [Menu > Controller mode](#)

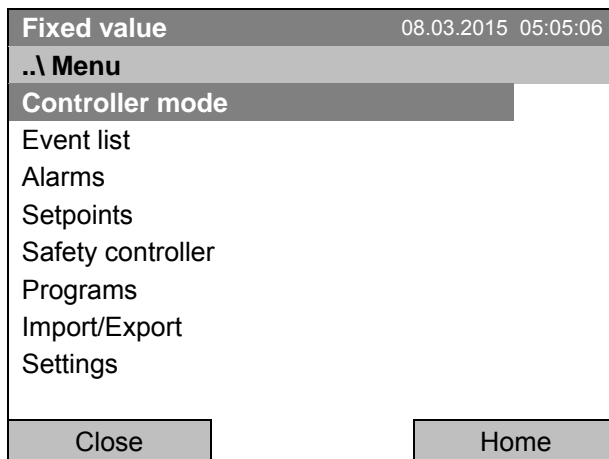

General menu.
Select “Controller Mode”
and press the operating button.

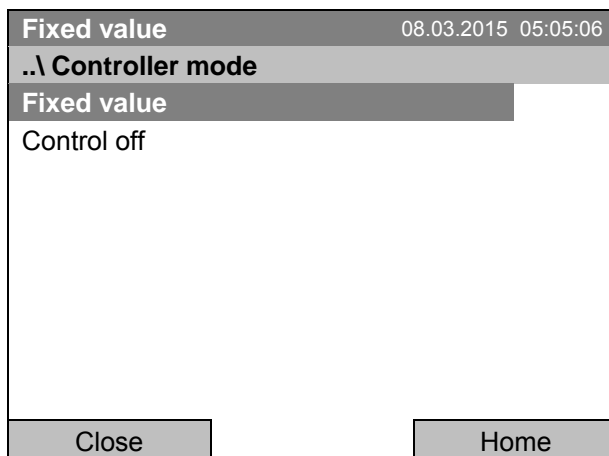

Submenu “Controller Mode”.
Select the desired controller mode
“Control off” or “Fixed value”
and press the operating button.

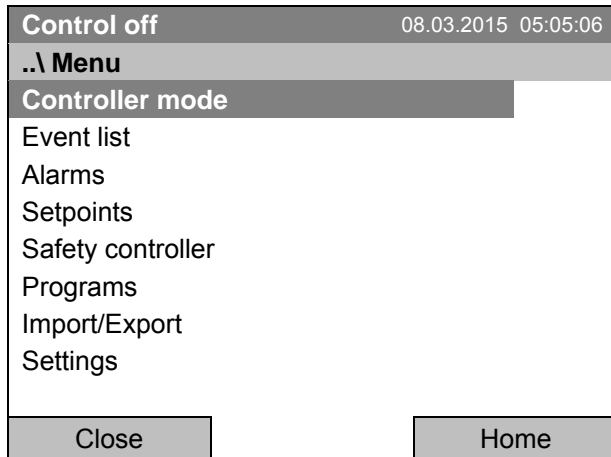

General menu with controller mode “Control off”.
The controller mode “Fixed value” or “Control off” is indicated in the display headline.

Go back to the initial view with “Home”.

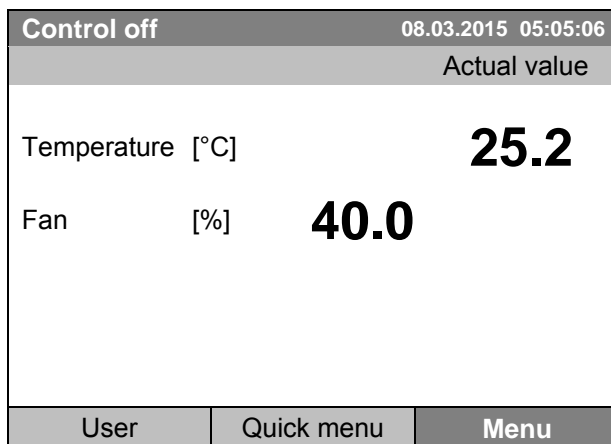

Initial view in “Control off” mode
(sample picture).

The controller is non-functional, i.e., there is no heating or refrigerating. The fan turns at 40 % speed.

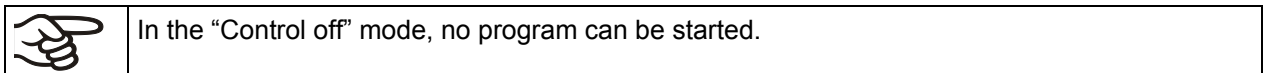

6.3 Performance during and after power failure

During a power failure, all controller functions are shut down. The optional zero-voltage relay alarm output (chap. 19.5) is switched to alarm position for the whole duration of the power failure.

After the power returns, all functions return to the same status the chamber had before power failure. . The controller continues to function in the original operating mode it was in previously before the power failure occurred.

- Performance after power failure in “fixed value” operation mode

All functions return to the same status the chamber had before power failure. The set-points are immediately resumed.

- Performance after power failure during time program operation

The program is resumed at the point where the interruption occurred with the latest set-points reached during the program run.

- Performance after power failure during week program operation

The week program continues with the values corresponding to the current time.

In the “Control off” controller mode, no program can be started.

If the temperature has dropped below the alarm limit during power failure, confirm the alarm with the RESET button as soon as the correct values are reached again (chap. 14.4).

In the Event List (chap. 15) the message “Power supply was interrupted.” is shown.

6.4 Information

You access chamber information like the chamber type, serial no., firmware version etc. To display the system information, go to [Menu > System information](#)

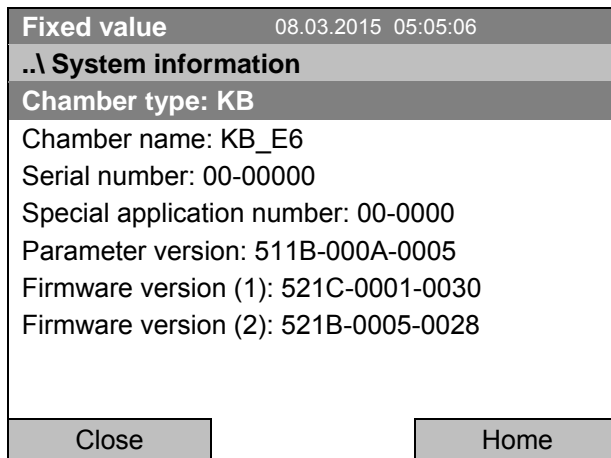

Submenu "System information" (sample values).

To display the BINDER Service contact data, go to [Menu > Service contact](#)

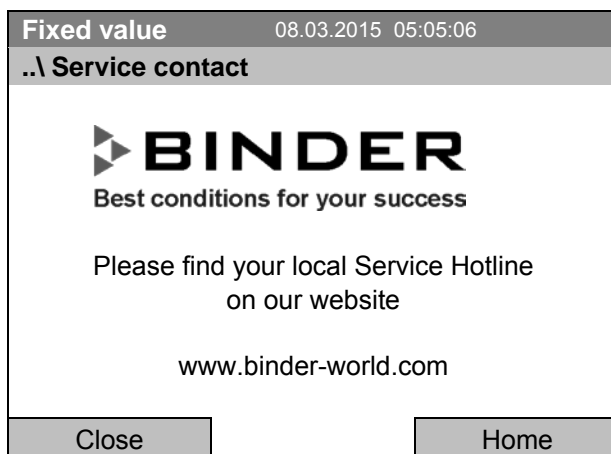

Submenu "Service contact".

Further information windows are accessible under [Menu > Settings > Network settings > Show network settings](#) (chap. 12.9) and – for service purpose – under [Menu > Settings > Chamber configuration](#) (chap. 12.10).

7. Configuration of optional equipment



The "Optional equipment" menu item is visible only with optional chamber equipment.

To access the selection menu, go to [Menu > Optional equipment](#)

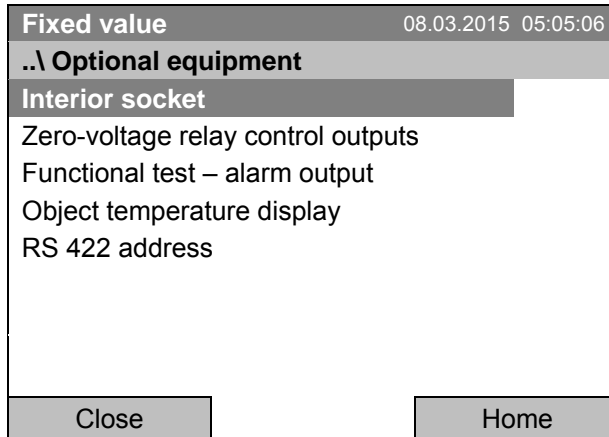

Submenu "Optional equipment".
Select the desired function
and press the operating button.

7.1 Turning on / off the optional interior socket

For chambers equipped with the water-protected interior socket (option, chap. 19.8) you can turn on and off the voltage of the interior socket via the controller.

To access the setting menu, go to [Menu > Optional equipment > Interior socket](#)

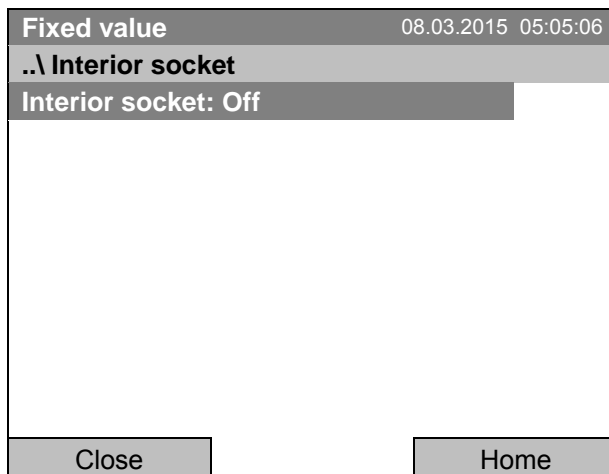

Submenu "Interior socket".
The current setting is indicated.
To change the setting,
press the operating button.
The modified setting is displayed.

"Interior socket: Off" = socket voltage-free
"Interior socket: On" = socket with activated voltage

Go back to the initial view with "Home".



This symbol on the controller display indicates that the interior socket is activated.

7.2 Switching on or off the optional zero-voltage relay control outputs

For chambers equipped with zero-voltage relay outputs (available via BINDER INDIVIDUAL Customized Solutions, chap. 19.7), you can switch on or off the output via the controller.

To access the setting menu for the operating modes “Fixed value” and “Control off”, go to [Menu > Optional equipment > Zero-voltage relay control outputs](#).

The setting for program operation is done through the program editor (chap. 9.3.7).

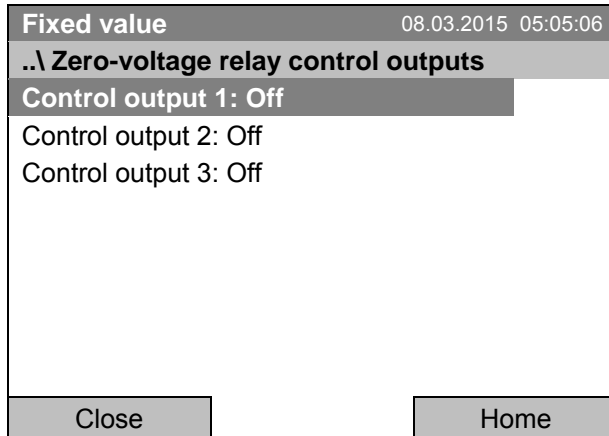

Submenu “Zero-voltage relay control outputs”.

The current switching state of the zero-voltage relay control outputs is indicated. To change it, select the desired control output

and press the operating button.

The modified switching state is displayed.

“Control output: Off” = zero-voltage relay output deactivated

“Control output: On” = zero-voltage relay output activated

Go back to the initial view with “Home”.

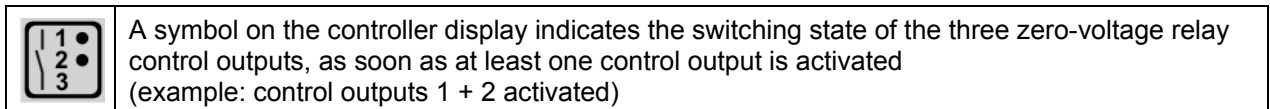

7.3 Functional test of the optional alarm output

For chambers equipped with the zero-voltage relay alarm output (option, chap. 19.5), you can switch on the output for test purpose via the controller and then switch it off again.

To access the setting menu, go to [Menu > Optional equipment > Functional test – alarm output](#)

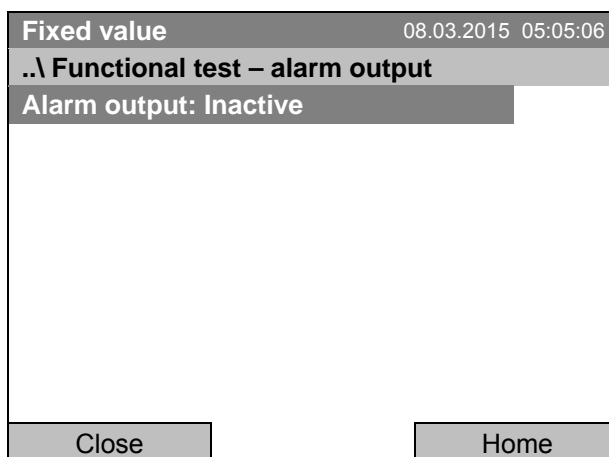

Submenu “Functional test – alarm output”.

The current switching state is indicated.

To change the switching state, press the operating button.

The modified switching state is displayed.

“Alarm output: Inactive” = alarm output switched off

“Alarm output: Active” = alarm output switched on (alarm state)

Go back to the initial view with “Home”.

7.4 Switching on or off the optional object temperature display

For chambers equipped with the digital object temperature display with a flexible Pt 100 temperature sensor (option, chap. 19.4), you can switch on or off the object temperature indication via the controller.

To access the setting menu, go to [Menu > Optional equipment > Object temperature display](#)

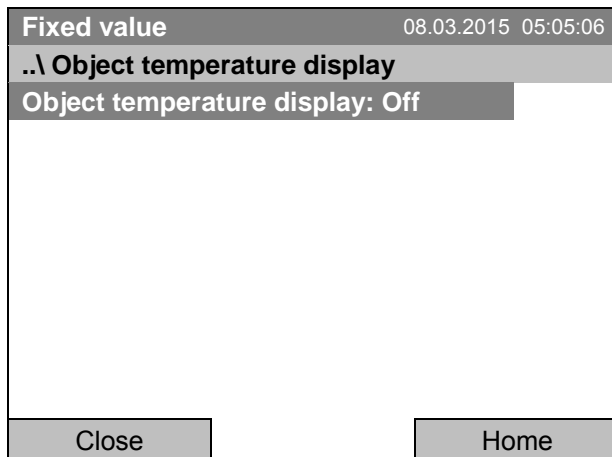

Submenu "Object temperature display".

The current setting is indicated.

To change the setting, press the operating button.

The modified setting is displayed.

"Object temperature display: Off" = Object temperature display deactivated

„Object temperature display: On“ = Object temperature display activated

Go back to the initial view with "Home".

7.5 RS 422 address (with optional RS 422 interface)

For chambers equipped with the optional RS 422 interface, the RS 422 address serves to identify the chamber in a network and to establish communication with the optional BINDER communication software APT-COM™ 3 DataControlSystem. The factory default setting is "1".

To enter the RS 422 chamber address, go to [Menu > Optional equipment > RS 422 address](#)

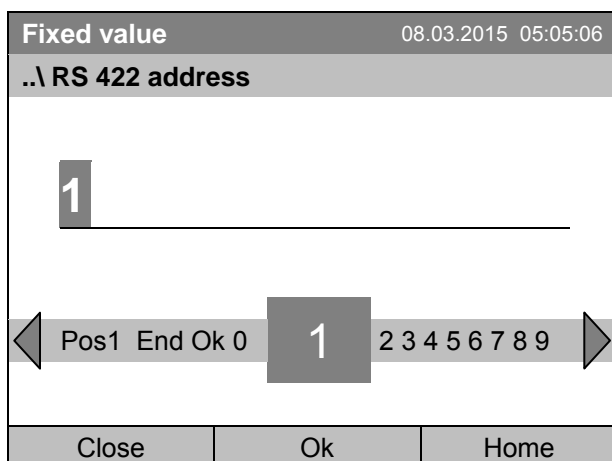

Entry menu "RS 422 address".

Enter the desired address (1 up to 254) with the operating button.

Press the "Ok" button to confirm.

When entering a value above 254, the message "invalid value" appears. Press the operating button to confirm with "Ok" and repeat the entry with a correct value.

Go back to the initial view with "Home".

8. Set-point entry in “Fixed value” operating mode

8.1 Set-point ranges

Temperature	Control range: -5 °C / 23 °F up to +100 °C / 212 °F Setting range: -10 °C / 14 °F up to +100 °C / 212 °F
Fan speed	40 % up to 100 % (full speed). Reduce the fan speed only if required, because the spatial distribution of temperature will also be reduced. Technical data refers to 100% fan speed.

	When you changed the temperature set-point, check the setting of the overtemperature safety controller class 3.1 (chap. 17.2) or the over-/undertemperature safety controller class 3.3 (option, chap. 17.3). With set-point type “Limit”, adapt the safety controller always when changing the temperature set-point.
---	---

8.2 Entering the set-points via “quick menu”

To enter set-points via quick menu, go to [Quick menu](#).

Fixed value	08.03.2015 05:05:06
..\ Quick menu	
Measurement chart	
Active alarms	
Temperature setpoint	
Fan speed setpoint	
Safety controller setpoint	
Time program	
Week program	
Close	Home

“Quick menu”.
Select the desired parameter and press the operating button.

	When trying to enter a setpoint in the „Controller off“ operating mode, a notification window shows “Controller mode is OFF!”. Press the operating button to confirm with “Ok” and change the operating mode to “Fixed value” (chap. 6.2.1).
---	--

Temperature setting

To enter the temperature setpoint, go to [Quick menu > Temperature setpoint](#)

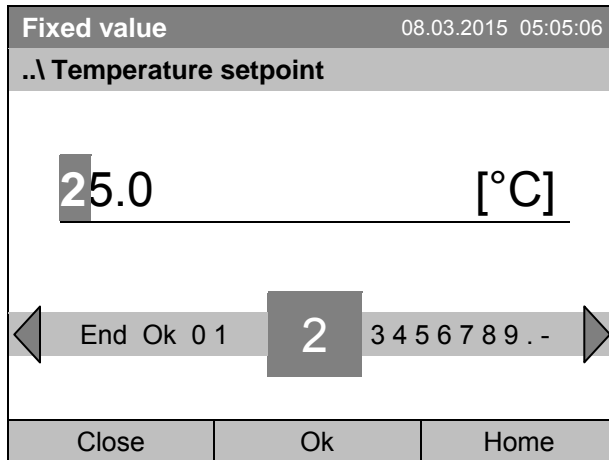

Entry menu "Temperature setpoint".
 Select each number with the operating button and press the operating button to confirm.
 Setting range: -10 °C / 14 °F up to +100 °C / 212 °F
 Press the "Ok" button to confirm.

When entering a value outside the setting range, the message "invalid value" appears. Press the operating button to confirm with "Ok" and repeat the entry with a correct value.

Go back to the initial view with "Home" or enter the fan speed.

Fan speed setting

To enter the fan speed setpoint, go to [Quick menu > Fan speed setpoint](#)

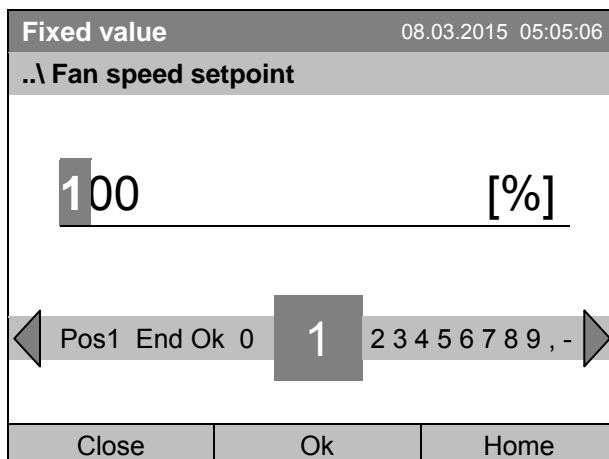

Entry menu "Fan speed setpoint".
 Select each number with the operating button and press the operating button to confirm.
 Setting range: 40 % up to 100 %.
 Press the "Ok" button to confirm.

When entering a value outside the setting range, the message "invalid value" appears. Press the operating button to confirm with "Ok" and repeat the entry with a correct value.

Go back to the initial view with "Home".



When operating the fan with less than 100 % speed, the temperature performance and the spatial exactitude of the temperature may differ from the manufacturer's specifications. Do reduce the fan speed only if absolutely necessary due to special requirements.

8.3 Entering the set-points via general menu

To enter set-points via general menu, go to [Menu > Setpoints](#)

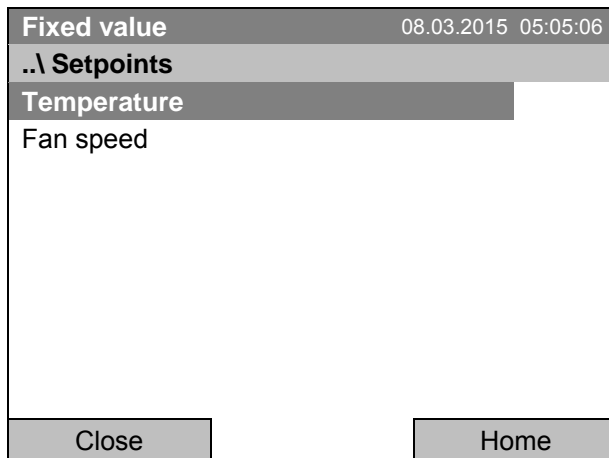

Submenu "Setpoints".
Select "Temperature" or "Fan speed"
and press the operating button.

Temperature setting

To enter the temperature setpoint, go to [Menu > Setpoints > Temperature](#)

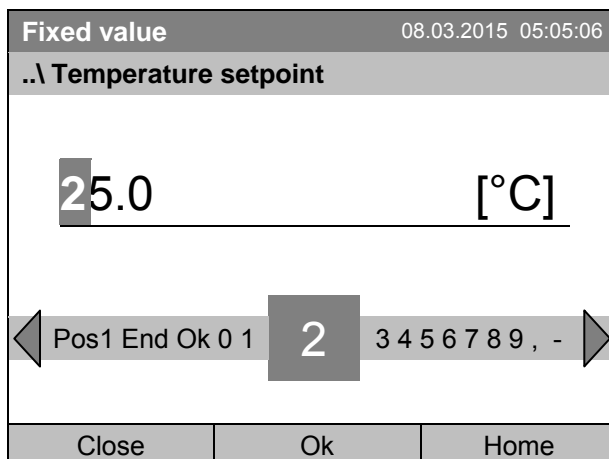

Entry menu "Temperature setpoint".
Select each number with the operating button and
press the operating button to confirm.
Setting range: -10 °C / 14 °F up to +100 °C / 212 °F
Press the "Ok" button to confirm.

When entering a value outside the setting range, the message "Invalid value" appears. Press the operating button to confirm with "Ok" and repeat the entry with a correct value.

Go back to the initial view with "Home" or enter the fan speed.

Fan speed setting

To enter the fan speed setpoint, go to [Menu > Setpoints > Fan speed](#)

Fixed value		08.03.2015 05:05:06
..\ Fan speed setpoint		
100 [%]		
◀ Pos1 End Ok 0	1	2 3 4 5 6 7 8 9 . - ▶
Close	Ok	Home

Entry menu "Fan speed setpoint".

Select each number with the operating button and press the operating button to confirm.

Setting range: 40 % up to 100 %.

Press the "Ok" button to confirm.

When entering a value outside the setting range, the message "invalid value" appears. Press the operating button to confirm with "Ok" and repeat the entry with a correct value.

Go back to the initial view with "Home".



When operating the fan with less than 100 % speed, the temperature performance and the spatial exactitude of the temperature may differ from the manufacturer's specifications. Do reduce the fan speed only if absolutely necessary due to special requirements.

9. Time programs

The T4.12 program controller permits programming temperature cycles. It offers 52 program memory positions with up to 100 program sections each.

To access the menu selection for time programs, select **Menu > Programs > Time program**

Fixed value		08.03.2015 05:05:06	
	Setpoint	Actual value	
Temperature [°C]	25.0	25.2	
Fan [%]	100.0		
			
User		Quick menu	
		Menu	

Initial view.

Press the “Menu” button.

Fixed value		08.03.2015 05:05:06	
..\ Menu			
Controller mode			
Event list			
Alarms			
Setpoints			
Safety controller			
Programs			
Import/Export			
Settings 			
Close		Home	

General menu.

Select “Programs” and press the operating button

Fixed value		08.03.2015 05:05:06	
..\ Programs			
Time program			
Week program			
Close		Home	

Submenu “Programs”.

Select “Time Program” and press the operating button

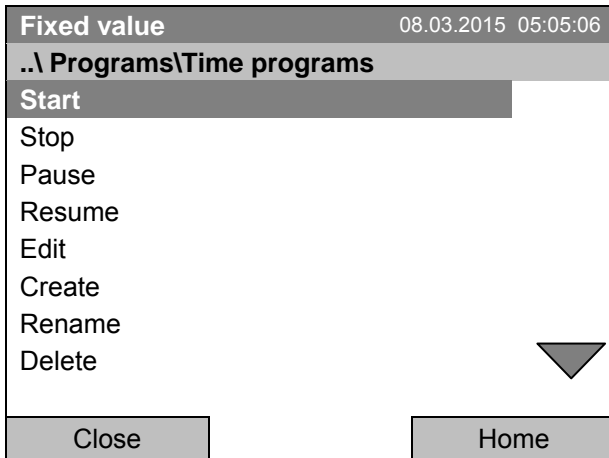

Submenu "Time programs".
Turn the operating button to see additional menu items.

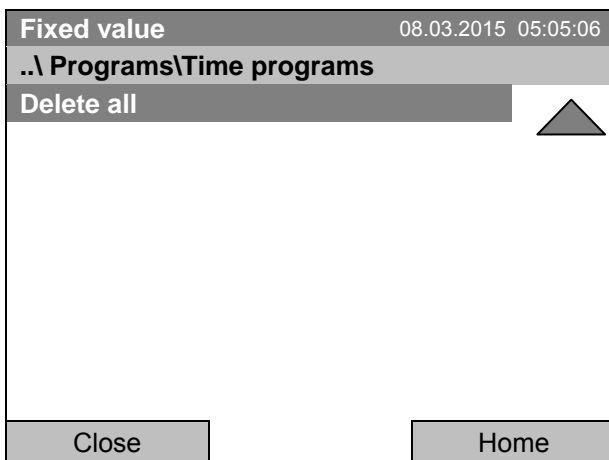

Submenu "Time programs" (next page)

9.1 Starting and running an existing time program

To start a time program, go to *Menu > Programs > Time program > Start*.

(You can also go to *Quick menu > Time program > Start*, see below).

Starting is also possible directly from the program editor (chap. 9.3.9).

	In the "Control off" mode or during a running time or week program, no time program can be started.
---	---

Fixed value		08.03.2015 05:05:06
..\ Programs\Time programs		
Start		
Stop		
Pause		
Resume		
Edit		
Create		
Rename		
Delete		
Close		Home

Submenu "Time programs".

Select "Start" to start an existing program and press the operating button.

If no program has been created and saved so far, the message "No programs found" appears. Press the operating button to confirm with "Ok" and enter a program with "Create".

Fixed value		08.03.2015 05:05:06
..\ Select program		
Program0001		
Program0002		
Program0003		
Close		Home

Submenu "Select program" (example).

Select one of the programs and press the operating button to run the program

Fixed value		08.03.2015 05:05:06
..\ Start date (DD.MM.YYYY)		
08.03.2015		
◀ Ins Pos1 End Ok 0 1 2 3 4 5 6 7 8 9 ▶		
Close	Ok	Home

Entry menu "Start date".

The current date is shown. For a postponed start, enter the desired start date with the operating button.

Press the "Ok" button to confirm.

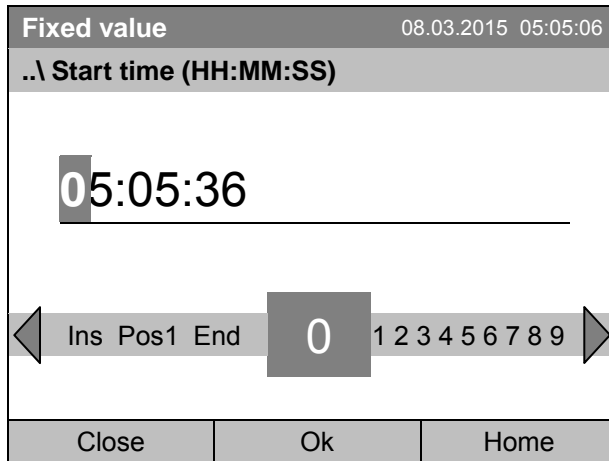

Entry menu "Start time".

The current time plus 30 seconds is shown. For a postponed start, enter the desired start time with the operating button.

Press the "Ok" button to confirm.

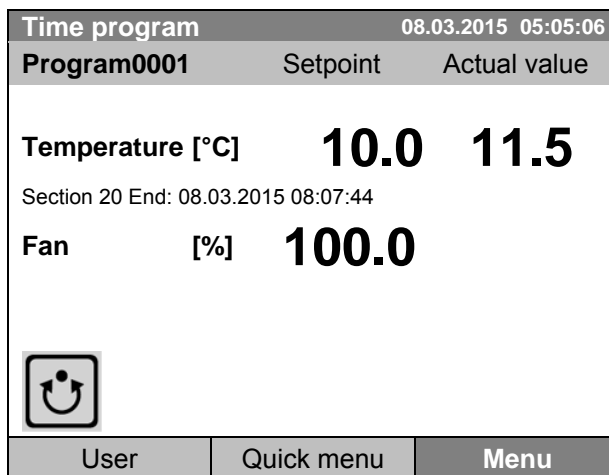

Initial view (example values).

The time program is running.

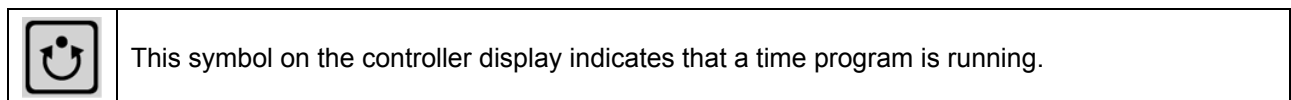

During a running time program, it is impossible to edit, rename or delete this program (when selecting such a function, a corresponding message is displayed). The other program functions are available.

During a running time program, no week program can be started.

To start a time program, you can also go to [Quick menu > Time program > Start](#)

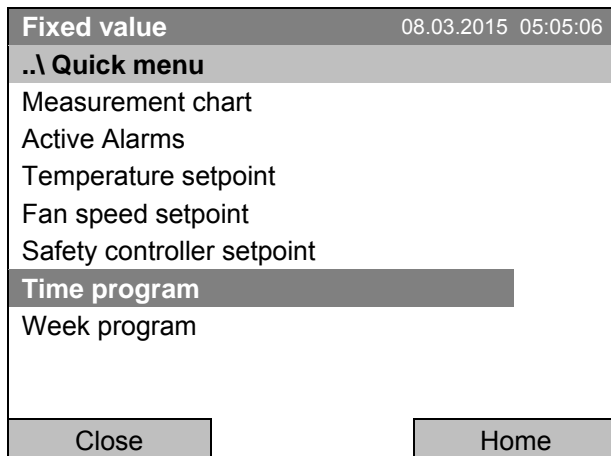

“Quick menu”.
Select “Time program”
and press the operating button

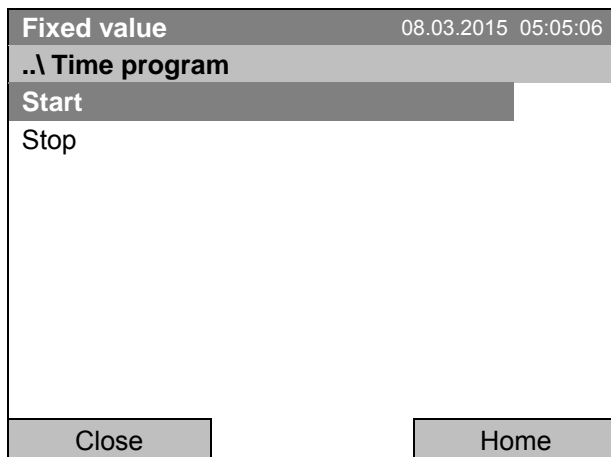

Submenu “Time program”.
Select “Start” to start an existing program
and press the operating button.

The further procedure is equal to that described for the general menu.

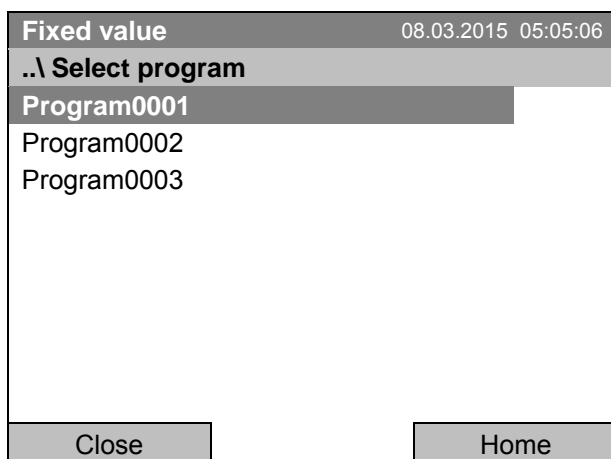

Submenu “Select program” (example).
Select one of the programs
and press the operating button to start the program

Performance after completing the program

The controller automatically changes to the “Fixed value” operation mode.

Before starting the program, check the temperature setpoint entered in the “Fixed value” operation mode. After end of the program, the temperature will equilibrate to this value.

	CAUTION
	<p>Too high or too low temperature after the program ends. Damage to the charging material.</p> <ul style="list-style-type: none">➤ Before starting the program, check the temperature setpoint of “Fixed value” operation and if necessary adapt it.

9.2 Cancelling a running time program

To cancel a running time program, go to [Menu > Programs > Time program > Stop](#).

To cancel a running time program, you can also go to [Quick menu > Time program > Stop](#).

The controller returns to the initial view.

Performance after manual program stop

The controller automatically changes to the “Fixed value” operation mode.

Before starting a program, check the temperature setpoint entered in the “Fixed value” operation mode. After cancelling the program, the temperature will equilibrate to this value.

	CAUTION
	<p>Too high or too low temperature after cancelling the program. Damage to the charging material.</p> <ul style="list-style-type: none">➤ Before starting the program, check the temperature setpoint of “Fixed value” operation and if necessary adapt it.

9.3 Creating a new time program

For each program section you can enter a temperature set-point, the fan speed, the section's duration, the type of temperature transition "R" (ramp) or "S" (step) (see chap. 9.3.6), and the tolerance range.

	When changing the temperature set-point, check the setting of the safety controller (chap. 17.2 and 17.3) if the safety controller has been set to "Limit" mode.
---	--

	If the fan is operated with less than 100 % speed, the temperature performance and the spatial exactitude of the temperature can differ from the manufacturer's specifications. The fan speed rate should only be reduced if absolutely necessary to meet special requirements.
---	---

Programming is saved in case of a power failure or after turning off the chamber.

To enter a new time program, go to [Menu > Programs > Time programs > Create](#)

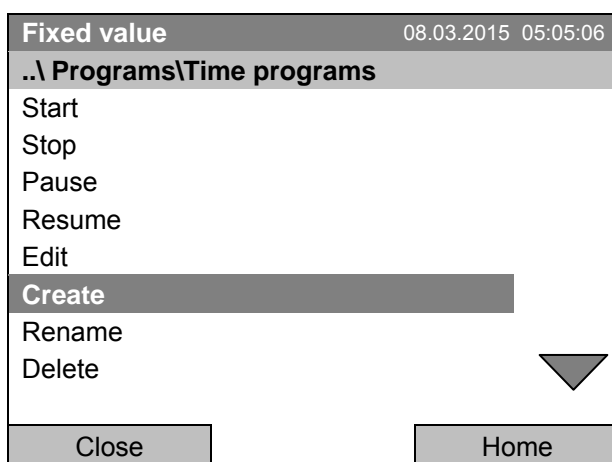

Submenu "Time program".
Select "Create"
and press the operating button.

Creating a new program

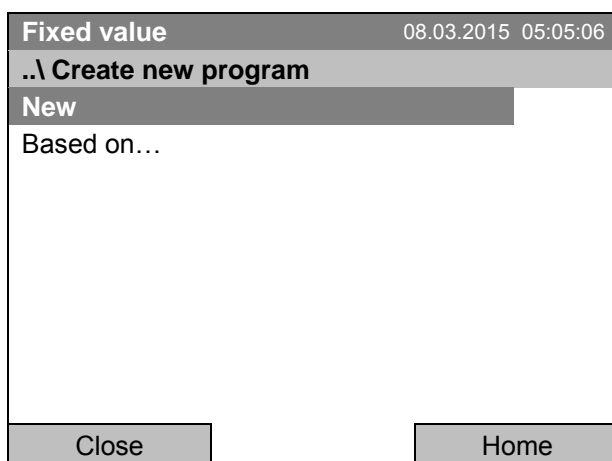

Submenu "Create new program".
Select "New", to create an entirely new program, or
"Based on...", to use an existing program for further
editing
and press the operating button.

If you selected "Based on", then the program selection window appears:

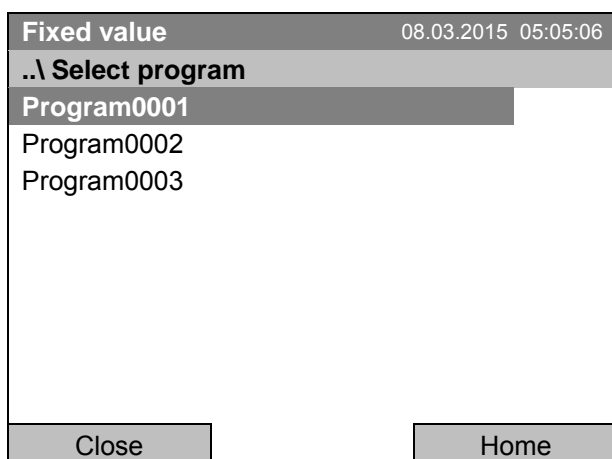

Submenu "Select program" (example).
Select the desired program
and press the operating button.

If no program has been created and saved so far, the message "No programs found" appears. Press the operating button to confirm with "Ok" and enter a program with "Create".

Now you can specify the name of the new time program:

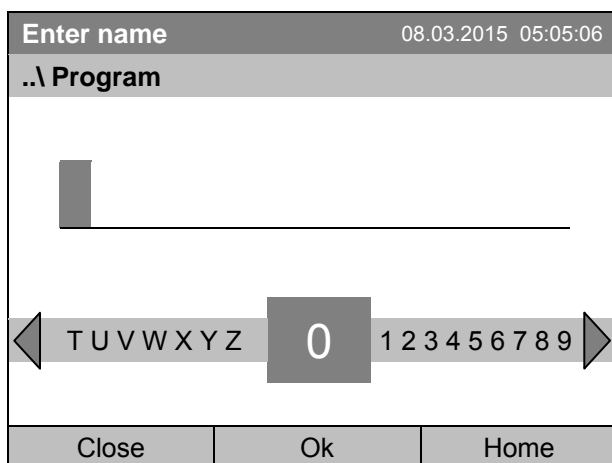

Entry menu "Program".
Enter the desired start time with the operating button.
Press the "Ok" button to confirm.

The time program editor is displayed. Following the selection "Based on...", this table for program entry shows the values of the selected program. Following the selection "New" there is an empty table, which can be filled section by section with sample values. You can edit the displayed values.

Entering the program values for the first parameter (temperature)

A first program line is shown. This corresponds to a program section. You can now edit the values.

Fixed value		08.03.2015 05:05:06						
..\ Temperature controller								
No.	Value	H:M:S	Ref.	Rep.	T. min	T.max	R/S	1 2 3
1	25.00	00:00:15	1	0	-999.00	999.00	Ramp	0 0 0
			Menu					

Time program editor
(view with optional control outputs).
To edit the values, press the operating button, select
the desired value and press the operating button
again.

To create a second program line (section), turn the operating button to the right and press it. The next section will be added.

Fixed value								08.03.2015 05:05:06	
..\ Temperature controller									
No.	Value	H:M:S	Ref.	Rep.	T. min	T.max	R/S	[1][2][3]	
1	25.00	00:00:15	1	0	-999.00	999.00	Ramp	[0][0][0]	
2	25.00	00:00:15	1	0	-999.00	999.00	Ramp	[0][0][0]	
3	25.00	00:00:15	1	0	-999.00	999.00	Ramp	[0][0][0]	
								<input type="text"/>	
								<input type="text"/>	
								<input type="text"/>	
								<input type="text"/>	
								<input type="text"/>	
			Menu						

Time program editor
(view with optional control outputs).

To edit the values, press the operating button, select the desired value and press the operating button again.

The right column for the 3 control outputs is visible only on chambers equipped with optional control outputs.

9.3.1 Section handling

Fixed value								08.03.2015 05:05:06	
..\ Temperature controller									
No.	Value	H:M:S	Ref.	Rep.	T. min	T.max	R/S		
1	25.00	00:00:15	1	0	-999.00	999.00	Ramp		

Time program editor.
Select a value under "No."
and press the operating button.



Fixed value								08.03.2015 05:05:06	
..\ Program sections									
Insert									
Copy									
Paste									
Delete									
Close									

Submenu "Program sections".
Select the desired function
and press the operating button.

Note: When selecting „Insert“ or “Paste”, the new program section is inserted **before** the current section.

9.3.2 Temperature setpoint

Fixed value		08.03.2015 05:05:06					
..\ Temperature controller							[°C]
No.	Value	H:M:S	Ref.	Rep.	T. min	T.max	R/S
1	25.00	00:00:15	1	0	-999.00	999.00	Ramp

Time program editor.

Select a value under "Value" and press the operating button.



Fixed value		08.03.2015 05:05:06					
..\ Temperature setpoint							[°C]
25.00							
◀ Pos1 End Ok 0 1 2 3 4 5 6 7 8 9 , - ▶							
Close				Ok			

Entry menu "Temperature setpoint".

A temperature value is shown. Enter the desired value with the operating button.

Setting range: -10 °C / 14 °F up to +100 °C / 212 °F.

Press the "Ok" button to confirm.

When entering a value outside the setting range, the message "invalid value" appears. Press the operating button to confirm with "Ok" and repeat the entry with a correct value.

9.3.3 Section duration

Fixed value		08.03.2015 05:05:06					
..\ Temperature controller							[°C]
No.	Value	H:M:S	Ref.	Rep.	T. min	T.max	R/S
1	25.00	00:00:15	1	0	-999.00	999.00	Ramp

Time program editor.

Select a value under "H:M:S" and press the operating button.



Fixed value		08.03.2015 05:05:06					
..\ Section duration							[°C]
00:00:15							
◀ Ins Pos1 End Ok 0 1 2 3 4 5 6 7 8 9 ▶							
Close				Ok			

Entry menu "Section duration".

A duration value is shown. Enter the desired value with the operating button.

Press the "Ok" button to confirm.

9.3.4 Repeating one or several sections within a time program

Enter the number of the target section, which shall be the start of the repeat cycle, under “Ref.” and the number of repeats under “Rep.”. To have sections repeated infinitely enter the number of cycles “Rep.” as “-1”.

Fixed value		08.03.2015 05:05:06					
..\ Temperature controller [°C]							
No.	Value	H:M:S	Ref.	Rep.	T. min	T.max	R/S
1	25.00	00:00:15	1	0	-999.00	999.00	Ramp

Time program editor.
Select a value under “Ref.”
and press the operating button.



Fixed value		08.03.2015 05:05:06					
..\ Reference section							
1							
◀ Pos1 End Ok 0 1 2 3 4 5 6 7 8 9 ▶							
Close				Ok			

Entry menu “Reference section”.
Enter the target section number of the repeat cycle
with the operating button.
Press the “Ok” button to confirm.

Continue to enter the number of repeats:

Fixed value		08.03.2015 05:05:06					
..\ Temperature controller [°C]							
No.	Value	H:M:S	Ref.	Rep.	T. min	T.max	R/S
1	25.00	00:00:15	1	0	-999.00	999.00	Ramp

Time program editor.
Select a value under “Rep.”
and press the operating button.



Fixed value		08.03.2015 05:05:06					
..\ Number of repeats							
0							
◀ Del Pos1 End Ok 0 1 2 3 4 5 6 7 8 9 ▶							
Close				Ok			

Entry menu “Number of repeats”.
Enter the desired number of repeats with the operat-
ing button.
Press the “Ok” button to confirm.

The following example shows a time program where the sections 2 and 3 shall be repeated 30 times:

Fixed value		08.03.2015 05:05:06					
..\ Temperature controller							[°C]
No.	Value	H:M:S	Ref.	Rep.	T. min	T.max	R/S
1	40.00	00:30:00	1	0	-999.00	999.00	Ramp
2	60.00	01:30:00	1	0	-999.00	999.00	Ramp
3	80.00	01:00:00	2	30	-999.00	999.00	Ramp
4	20.00	03:20:00	1	0	-999.00	999.00	Ramp
▲		Menu		▼			

Time program editor.

Sections 2 and 3 will be executed in total 31 times; only then will the program continue.

9.3.5 Tolerance range

You can specify a tolerance range for each program section with different values for the tolerance minimum and maximum. When the actual value exceeds the given threshold, the program is interrupted. This is indicated on the display, see chap. 9.4. When the actual temperature is situated again within the entered tolerance limits, the program automatically continues. Therefore, the duration of the program may be extended due to the programming of tolerances.



Programming of tolerances may extend program duration.

An entry of “-999” for the tolerance minimum means “minus infinite” and an entry of “999” for the tolerance maximum means “plus infinite”. Entry of these values will never lead to program interruption.

When requesting a rapid temperature transition, we recommend not programming tolerance values in order to enable the maximum heating-up or cooling-down speed.

Start with the minimum value:

Fixed value		08.03.2015 05:05:06					
..\ Temperature controller							[°C]
No.	Value	H:M:S	Ref.	Rep.	T. min	T.max	R/S
1	25.00	00:00:15	1	0	-999.00	999.00	Ramp

Time program editor.

Select a value under “T. min” and press the operating button.



Fixed value		08.03.2015 05:05:06					
..\ Tolerance range minimum temperature							[°C]
- 999.00							
◀		2 3 4 5 6 7 8 9 ,	-	Del Ins Pos1		▶	
Close			Ok				

Entry menu “Tolerance range minimum temperature”.
Enter the desired value with the operating button.
Press the “Ok” button to confirm.

Continue to enter the maximum value:

Fixed value								08.03.2015 05:05:06
..\ Temperature controller								[°C]
No.	Value	H:M:S	Ref.	Rep.	T. min	T.max	R/S	
1	25.00	00:00:15	1	0	-999.00	999.00	Ramp	

Time program editor.

Select a value under "T. max" and press the operating button.



Fixed value		08.03.2015 05:05:06
..\ Tolerance range maximum temperature		
999.00		[°C]
<div style="display: flex; align-items: center; justify-content: center;"> ◀ 0 1 2 3 4 5 6 7 8 <div style="border: 1px solid black; padding: 2px 10px; margin: 0 5px;">9</div> , - Del Ins Pos1 ▶ </div>		
Close	Ok	

Entry menu "Tolerance range maximum temperature".

Enter the desired value with the operating button. Press the "Ok" button to confirm.

9.3.6 Set-point ramp and set-point step modes

“Ramp” mode

The set-point of a given program section functions as the section’s target temperature. During the section’s duration, the temperature set-point gradually passes from the set-point of the previous program section to this target set-point. The actual temperature value follows the continually changing set-point.

Programming in the “ramp” mode allows various kinds of temperature transitions:

- Gradual slow temperature changes
The set-point changes its value gradually during the entered section duration. The actual temperature value (X) follows the continually moving set-point (W) at any time.
- Constant temperature
The initial values of two subsequent program sections are identical; so the temperature remains constant during the duration of the first program section.
- Sudden temperature changes
These changes occur rapidly within the minimum amount of time (minimum entry: 1 second).

“Step” mode

The set-point of a given program section functions as the section’s target temperature. At the start of the program section, the chamber heats up or cools down with the maximum speed to reach the entered value; and then it holds it for the remaining section time. The set-point temperature remains constant for the section’s duration.

Selecting the setting “Ramp” or “Step”:

Fixed value								08.03.2015 05:05:06	
..\ Temperature controller								[°C]	
No.	Value	H:M:S	Ref.	Rep.	T. min	T.max	R/S		
1	25.00	00:00:15	1	0	-999.00	999.00	Ramp		

Time program editor.
Select a value under “R/S”
and press the operating button.



Fixed value								08.03.2015 05:05:06	
..\ Ramp/step									
Ramp									
Step									
Close									

Submenu “Ramp/step”.
Select the desired function
and press the operating button.

“Ramp” = Setpoint ramp mode selected
“Step” = Setpoint step mode selected

Examples:

“Ramp” mode

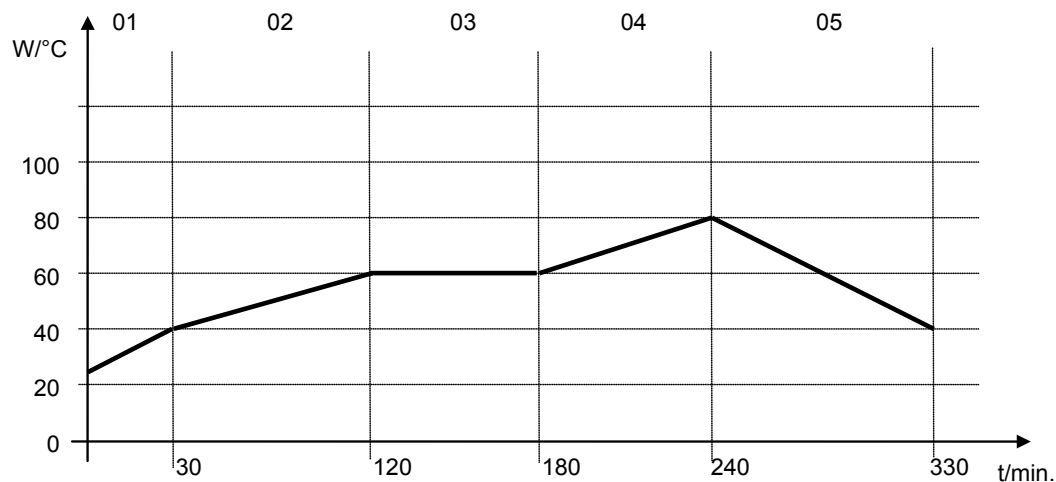

Corresponding program table:

No.	Value	H:M:S	Ref.	Rep.	T. min	T.max	R/S
01	40.0	00:30:00	1	0	-999	+999	Ramp
02	60.0	01:30:00	1	0	-5	+5	Ramp
03	60.0	01:00:00	1	0	-2	+2	Ramp
04	80.0	01:00:00	1	0	-999	+999	Ramp
05	40.0	01:30:00	1	0	-999	+999	Ramp

“Step” mode

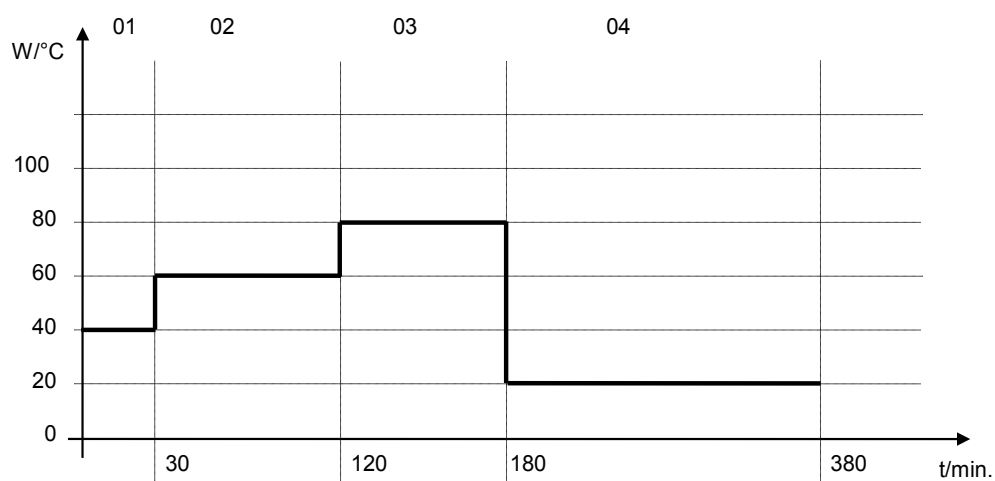

Corresponding program table

No.	Value	H:M:S	Ref.	Rep.	T. min	T.max	R/S
01	40.0	00:30:00	1	0	-999	+999	Step
02	60.0	01:30:00	1	0	-5	+5	Step
03	80.0	01:00:00	1	0	-2	+2	Step
04	20.0	03:20:00	1	0	-999	+999	Step

9.3.7 Switching on or off the optional zero-voltage relay outputs

For chambers equipped with zero-voltage relay outputs (option, chap. 19.7), you can switch on or off the outputs for each program section via the program editor.

Fixed value								08.03.2015 05:05:06	
..\ Temperature controller								[°C]	
No.	Value	H:M:S	Ref.	Rep.	T. min	T.max	R/S	[1][2][3]	
1	25.00	00:00:15	1	0	-999.00	999.00	Rampe	[0][0][0]	

Time program editor (with option relay outputs)

Select a field under “**[1][2][3]**” and press the operating button.



Fixed value								08.03.2015 05:05:06	
..\ Zero -voltage relay outputs									
Outputs 1 [Off] 2[Off] 3[Off]									
Outputs 1[On] 2[Off] 3[Off]									
Outputs 1[Off] 2[On] 3[Off]									
Outputs 1[On] 2[On] 3[Off]									
Outputs 1[Off] 2[Off] 3[On]									
Outputs 1[On] 2[Off] 3[On]									
Outputs 1[Off] 2[On] 3[On]									
Outputs 1[On] 2[On] 3[On]									
Close									

Submenu “Zero -voltage relay outputs”.

The possible combination of switching states are indicated.

Select the desired combination of switching states and press the operating button.“



[On] = zero-voltage relay outputs turned on
[Off] = zero-voltage relay outputs turned off



A symbol on the controller display indicates the switching state of the three zero-voltage relay outputs as soon as at least one output is switched on (example: outputs 1 + 2 turned on)

9.3.8 Calling up the next parameter

Fixed value		08.03.2015 05:05:06					
..\ Temperature controller							[°C]
No.	Value	H:M:S	Ref.	Rep.	T. min	T.max	R/S
1	40.00	00:30:00	1	0	-999.00	999.00	Step
2	60.00	01:30:00	1	0	-5.00	5.00	Step
3	80.00	01:00:00	1	0	-5.00	5.00	Step
4	20.00	03:20:00	1	0	-999.00	999.00	Step
5	40.00	00:30:00	1	0	-999.00	999.00	Step
6	60.00	01:30:00	1	0	-5.00	5.00	Step
7	70.00	01:00:00	1	0	-5.00	5.00	Step
8	60.00	01:00:00	1	0	-5.00	5.00	Step

Menu

Time program editor (example).
Press the "Menu" button.

Fixed value		08.03.2015 05:05:06					
..\ Program menu							
Select parameter							
Save and exit							
Save and run							
Exit (without saving!)							
Close							

Submenu "Program menu".
Select "Select parameter"
and press the operating button.



With the "Close" button, the controller returns to the time program editor.

Fixed value		08.03.2015 05:05:06					
..\ Program parameters							
Temperature controller							
Fan speed							
Close							

Submenu "Program parameters".
Select "Fan speed main controller"
and press the operating button.

Entering the set-point values for another parameter (fan speed)

The number of program lines (program sections) equal to the number in the temperature program is displayed. The settings of section length, repeats and the selection „Ramp“ or „Step“ are taken over from the temperature program; they are no editable in this view. The symbol “ *** ” indicates that there are no tolerance value required for the fan speed. You can enter the fan speed set-points.

 If you want to insert further sections or perform any other programming, first change back to the temperature program through [Menu > Select parameter > Temperature controller](#).

Fixed value								08.03.2015 05:05:06
..\ Fan speed								[%]
No.	Value	H:M:S	Ref.	Rep.	T. min	T.max	R/S	
1	100.00	00:30:00	1	0	***	***	Ramp	
1	100.00	00:10:00	1	0	***	***	Ramp	
1	100.00	00:30:00	2	3	***	***	Ramp	
1	100.00	01:00:00	1	0	***	***	Ramp	
Menu								

Time program editor (example).

To edit the values, press the operating button, select the desired value and press the operating button again.

Entering the fan speed setpoint

Fixed value								08.03.2015 05:05:06
..\ Fan speed								[%]
No.	Value	H:M:S	Ref.	Rep.	T. min	T.max	R/S	
1	100.00	00:00:15	1	0	***	***	Ramp	

Time program editor.

Select a value under “Value” and press the operating button.



Fixed value		08.03.2015 05:05:06
..\ Fan setpoint		[%]
<div style="border: 1px solid black; padding: 5px; display: inline-block;"> 100 </div>		
<div style="border: 1px solid black; padding: 5px; display: inline-block;"> 1 </div>		
← Pos1 End Ok 0 1 2 3 4 5 6 7 8 9 , →		
Close		Ok

Entry menu “Fan setpoint”.

A fan speed value is shown. Enter the desired value with the operating button.

Setting range: 40 % up to 100 %

Press the “Ok” button to confirm.

When entering a value outside the setting range, the message “invalid value” appears. Press the operating button to confirm with “Ok” and repeat the entry with a correct value.

9.3.9 Saving the time program and leaving the program editor

Fixed value				08.03.2015 05:05:06			
..\ Temperature controller							[°C]
No.	Value	H:M:S	Ref.	Rep.	T. min	T.max	R/S
1	40.00	00:30:00	1	0	-999.00	999.00	Step
2	60.00	01:30:00	1	0	-5.00	5.00	Step
3	80.00	01:00:00	1	0	-5.00	5.00	Step
4	20.00	03:20:00	1	0	-999.00	999.00	Step
5	40.00	00:30:00	1	0	-999.00	999.00	Step
6	60.00	01:30:00	1	0	-5.00	5.00	Step
7	70.00	01:00:00	1	0	-5.00	5.00	Step
8	60.00	01:00:00	1	0	-5.00	5.00	Step
▲		Menu			▼		

Time program editor (example).
Press the “Menu” button.

Fixed value		08.03.2015 05:05:06	
..\ Program menu			
Select parameter			
Save and exit			
Save and run			
Exit (without saving!)			
Close			

Submenu “Program menu”.
Select the desired function
and press the operating button.

With the “Close” button, the controller returns to the time program editor.

Select parameter	Changing between temperature and fan speed.
Save and exit	Saving the program. The controller returns to the “Time programs” submenu. You can now select and start the program as described in chap. 9.1.
Save and run	Saving the program and start it. Enter the start date and time, see chap. 9.1. If another time or week program is running, the program is only saved, but not started. A corresponding message is displayed.
Exit (without saving!)	Attention: the program is not saved. After a security question, the controller returns to the initial view.
Button “Close”	The controller returns to the time program editor. You can continue programming.



Make sure that you saved the time program before leaving the program editor.

With “Exit (without saving!)” you exit the program editor without saving the program. There is a security question first:

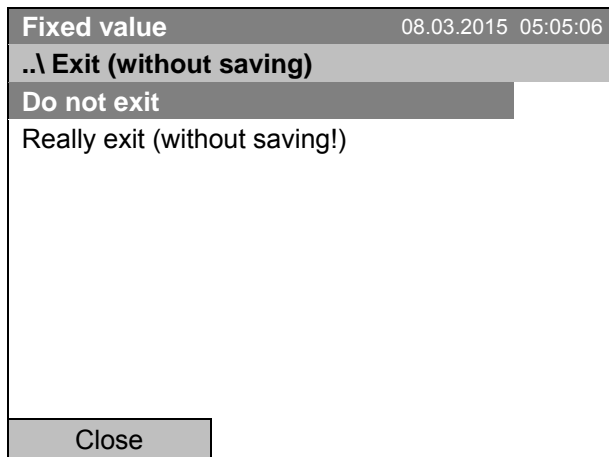

Submenu “Exit (without saving)”.

This a security question. Select the desired function and press the operating button.

If you selected “Really exit (without saving!)”, the controller goes back to the initial view.

9.4 Program interruption

You can manually interrupt a time program (pause), or this will automatically occur when exceeding the entered tolerance range values of the corresponding program section (see chap. 9.3.5).

Manual program interruption

To interrupt a time program, go to [Menu > Programs > Time programs > Pause](#)

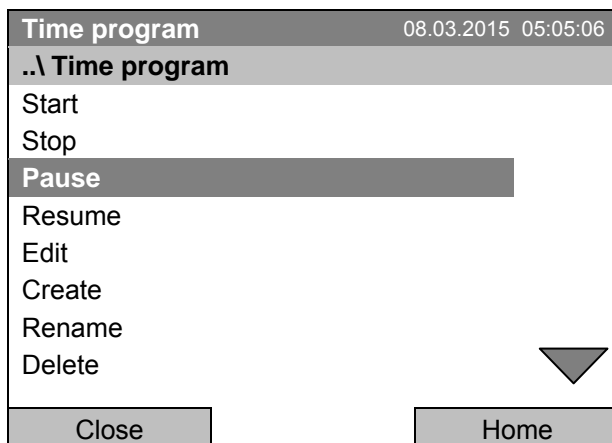

Submenu "Time program".

Select "Pause" to interrupt the running time program and press the operating button.

With button "Home" the controller returns to the initial view.

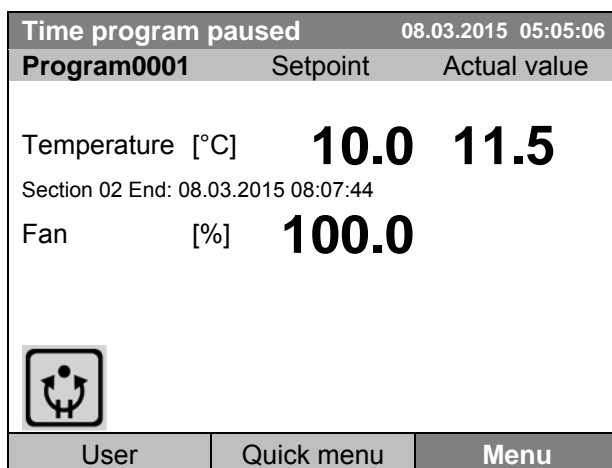

Initial view (example values).

The time program is running, but halted. The final time (in this example: 08:07:44) is running.



This symbol on the controller display indicates that a running time program is interrupted.

Continuing the time program after a manual interruption

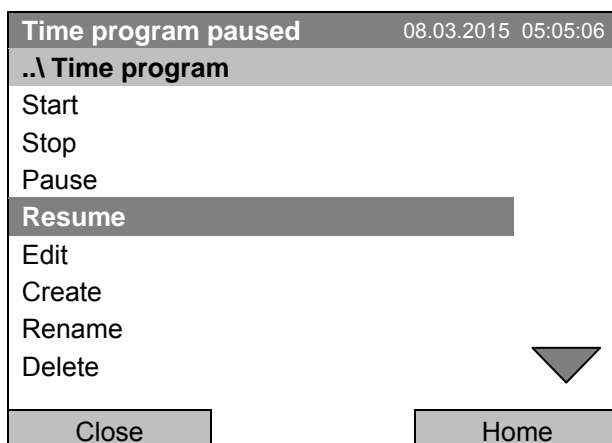

Submenu "Time program".

Select "Resume" to continue the time program and press the operating button.

With button "Home" the controller returns to the initial view.

9.5 Deleting a time program

To delete a time program, go to *Menu > Programs > Time program > Delete* or *Menu > Programs > Time program > Delete all*

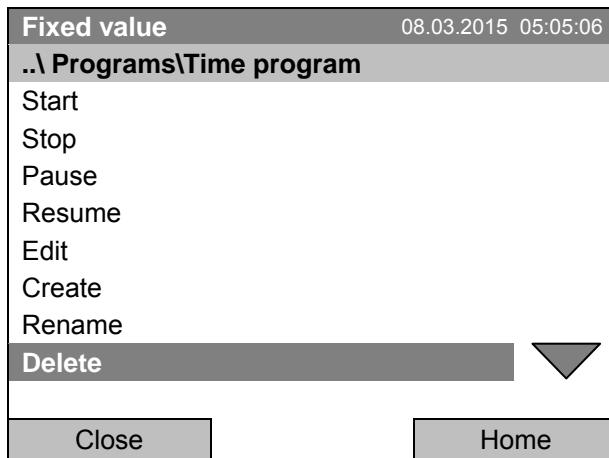

Submenu "Time program".
Select "Delete" or "Delete all" (next page)
and press the operating button

If you selected "Delete", select then the time program to be deleted and press the operating button.

If you selected "Delete all", all time programs will be deleted in the controller.

Before deleting there is a security question:

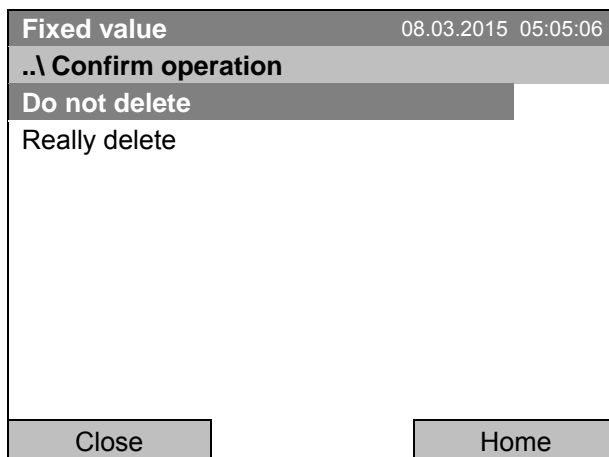

Submenu "Confirm operation".
This a security question. Select the desired function
and press the operating button.

Go back to the initial view with "Home".

10. Week programs

The T4.12 program controller permits programming week programs with real-time reference. It offers 8 week program places in total with up to 30 shift points for each week program.

To access the menu selection for week programs, select [Menu > Programs > Week program](#)

Fixed value		08.03.2015 05:05:06	
	Setpoint	Actual value	
Temperature [°C]	25.0	25.2	
Fan [%]	100.0		
			
User		Quick menu	
		Menu	

Initial view.
Press the “Menu” button.

Fixed value		08.03.2015 05:05:06	
..\ Menu			
Controller mode			
Event list			
Alarms			
Setpoints			
Safety controller			
Programs			
Import/Export			
Settings 			
Close		Home	

General menu.
Select “Programs”
and press the operating button

Fixed value		08.03.2015 05:05:06	
..\ Programs			
Time program			
Week program			
Close		Home	

Submenu “Programs”.
Select “Week Program”
and press the operating button

10.1 Starting and running an existing week program

To start a week program, go to [Menu > Programs > Week program > Start](#)

(You can also go to [Quick menu > Week program > Start](#), see below).

Starting is also possible directly from the program editor (chap. 10.3.8).



In the "Control off" mode or during a running time or week program, no week program can be started.

Fixed value		08.03.2015 05:05:06
..\ Programs\Week Programs		
Start		
Stop		
Edit		
Create		
Rename		
Delete		
Delete all		
Close		Home

Submenu "Week Programs".

Select "Start" to start an existing week program and press the operating button

Fixed value		08.03.2015 05:05:06
..\ Select program		
Program0004		
Program0005		
Day-Night		
Close		Home

Submenu "Select program" (example).

Select one of the programs and press the operating button to run the program

If no program has been created and saved so far, the message "No programs found" appears. Press the operating button to confirm with "Ok" and enter a program with "Create".

Fixed value		08.03.2015 05:05:06	
..\ Start date (DD.MM.YYYY)			
08.03.2015			
◀	End Ok 0 1 2 3	4	5 6 7 8 9 , - Del ▶
Close		Ok	Home

Entry menu "Start date".

The current date is shown. For a postponed start, enter the desired start date with the operating button.

Press the "Ok" button to confirm.

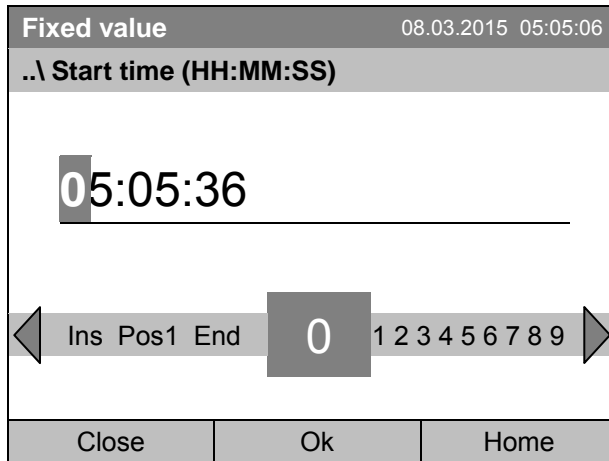

Entry menu "Start time".

The current time plus 30 seconds is shown. For a postponed start, enter the desired start time with the operating button.

Press the "Ok" button to confirm.

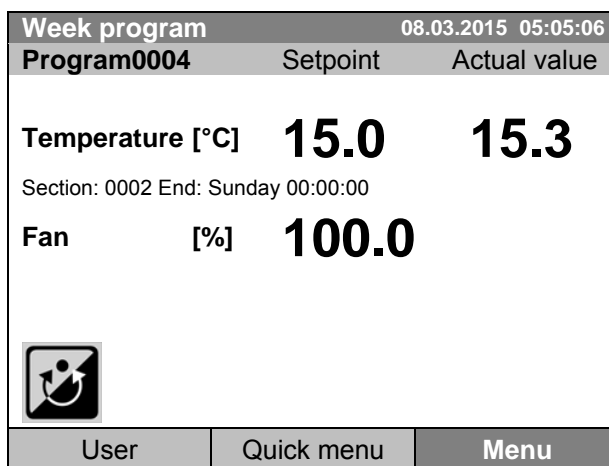

Initial view.

The week program is running.



This symbol on the controller display indicates that a week program is running.

During a running week program, it is impossible to edit, rename or delete this program (when selecting such a function, a corresponding message is displayed). The other program functions are available.

During a running week program, no time program can be started.

To start a week program, you can also go to [Quick menu > Week program > Start](#)

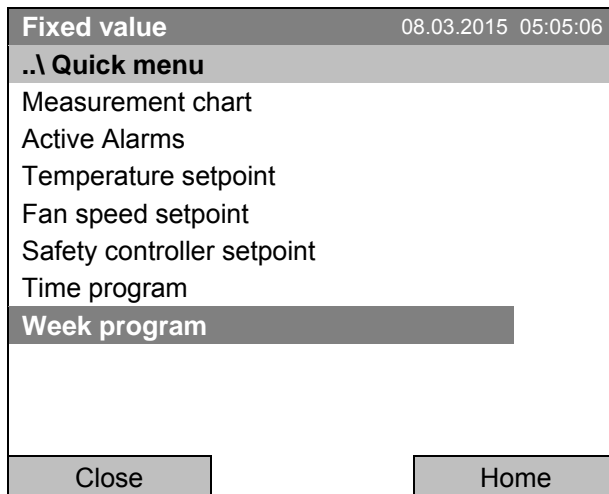

“Quick menu”.
Select “Week program”
and press the operating button

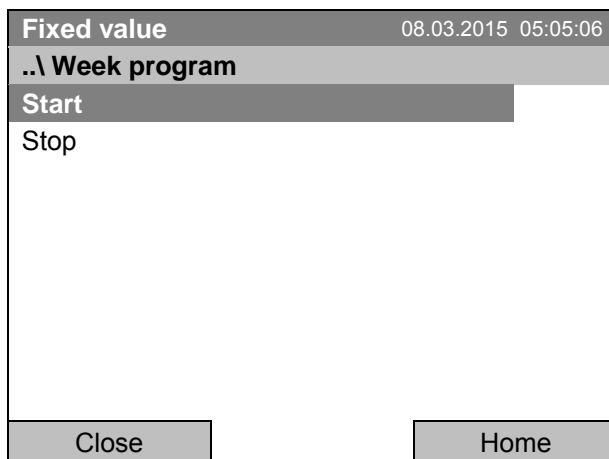

Submenu “Week program”.
Select “Start” to start an existing program
and press the operating button.

The further procedure is equal to that described for the general menu.

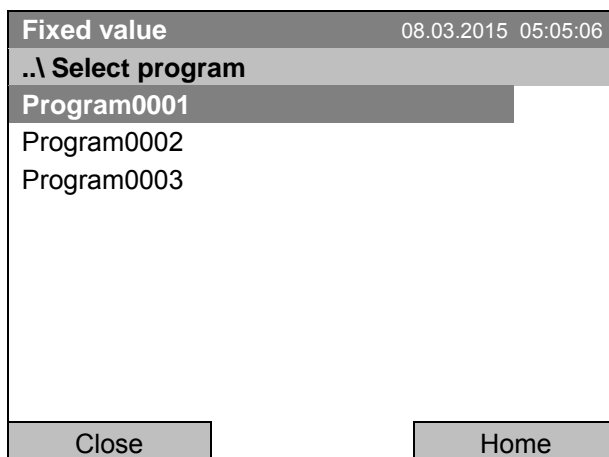

Submenu “Select program” (example).
Select one of the programs
and press the operating button to start the program

10.2 Cancelling a running week program

To cancel a week program, go to *Menu > Programs > Week program > Stop*.

To cancel a running week program, you can also go to *Quick menu > Week program > Stop*.

The controller returns to the initial view.

Performance after manual program stop

The controller automatically changes to the “Fixed value” operation mode.

Before starting a program, check the temperature setpoint entered in the “Fixed value” operation mode. After cancelling the program, the temperature will equilibrate to this value.

	CAUTION
	<p>Too high or too low temperature after cancelling the program. Damage to the charging material.</p> <p>➤ Before starting a program, check the temperature setpoint of “Fixed value” operation and if necessary adapt it.</p>

10.3 Creating a new week program

A week program permits defining up to 30 sections for the whole week. These sections function as shift points. A shift-point is characterized by its time, temperature value, and state (active / inactive). With a running week program, the temperature of the currently active shift point is maintained until the moment of the next active shift point with its new temperature set-point.

Example:

No.	Value	Day	H:M:S	Activity
1	35.00	Monday	08:00:00	Active
2	40.00	Monday	10:00:00	Active
3	35.00	Monday	18:00:00	Active
4	10.00	Monday	20:00:00	Active
5	35.00	Tuesday	08:00:00	Active
...

Programming is saved in case of a power failure or after turning off the chamber.

To enter a new week program, go to [Menu > Programs > Week program > Create](#)

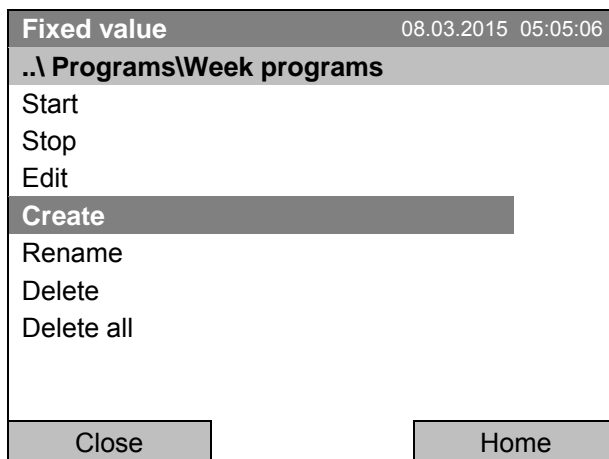

Submenu "Week program".
Select "Create"
and press the operating button.

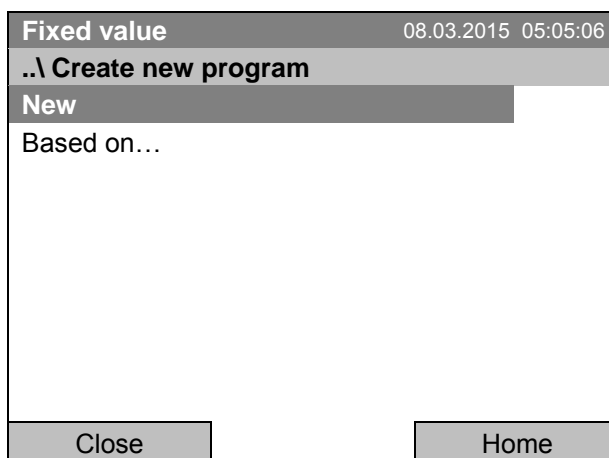

Submenu "Create new program".
Select "New", to create an entirely new program, or
"Based on", to use an existing program for further
editing
and press the operating button.

If you selected "Based on", then the program selection window appears:

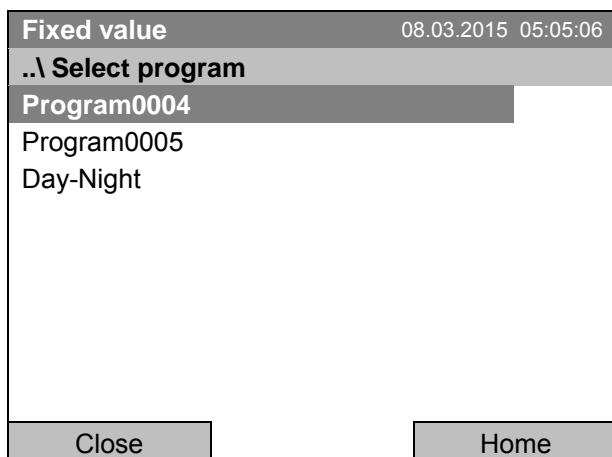

Submenu "Select program" (example).
Select the desired program
and press the operating button.

If no program has been created and saved so far, the message "No programs found" appears. Press the operating button to confirm with "Ok" and enter a program with "Create".

Now you can specify the name of the new week program:

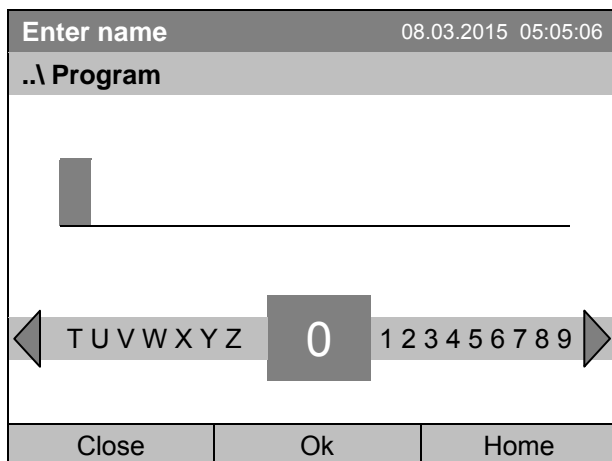

Entry menu "Program".
Enter the desired start time with the operating button.
Press the "Ok" button to confirm.

The week program editor is displayed. Following the selection "Based on...", this table for program entry shows the values of the selected program. Following the selection "New" there is an empty table, which can be filled section by section with sample values. You can then edit the displayed values.

Entering the program values for the first parameter (temperature)

A first program line is shown. This corresponds to a program section. You can now edit the values.

Fixed value		08.03.2015 05:05:06			
..\ Temperature controller					[°C]
No.	Value	Day	H:M:S	Activity	1 2 3
1	25.00	Monday	00:00:00	Inactive	0 0 0
					<input type="text"/>
					<input type="text"/>
					<input type="text"/>
					<input type="text"/>
					<input type="text"/>
					<input type="text"/>
					<input type="text"/>
		Menu			

Week program editor
(view with optional control outputs)
To edit the values, select the desired value and
press the operating button.

To create a second program line (section), turn the operating button to the right and press it. The next section will be added.

Fixed value					08.03.2015 05:05:06
..\ Temperature controller					[°C]
No.	Value	Day	H:M:S	Activity	<input type="text"/>
1	25.00	Monday	00:00:00	Inactive	<input type="text"/>
2	25.00	Monday	00:00:00	Inactive	<input type="text"/>
					<input type="text"/>
					<input type="text"/>
					<input type="text"/>
					<input type="text"/>
					<input type="text"/>
					<input type="text"/>
Menu					

Week program editor

(view with optional control outputs)

To edit the values, press the operating button, select the desired value and press the operating button again.

10.3.1 Section handling

Fixed value					08.03.2015 05:05:06
..\ Temperature controller					[°C]
No.	Value	Day	H:M:S	Activity	
1	25.00	Monday	00:00:00	Inactive	

Week program editor.

Select a value under “No.” and press the operating button.



Fixed value					08.03.2015 05:05:06
..\ Program sections					
Insert					
Copy					
Paste					
Delete					
Close					

Submenu “Program sections”.

Select the desired function and press the operating button.

Note: When selecting „Insert“ or “Paste”, the new program section is inserted **before** the current section.

10.3.2 Temperature setpoint

Fixed value		08.03.2015 05:05:06		
..\ Temperature controller [°C]				
No.	Value	Day	H:M:S	Activity
1	25.00	Monday	00:00:00	Inactive

Week program editor.
Select a value under “Value” and press the operating button.



Fixed value		08.03.2015 05:05:06		
..\ Temperature setpoint				
<div style="display: flex; justify-content: space-between; align-items: center;"> 25.00 [°C] </div>				
<div style="display: flex; justify-content: space-between; align-items: center;"> ◀ Pos1 End Ok 0 1 2 3 4 5 6 7 8 9 , - ▶ </div>				
Close		Ok		

Entry menu “Temperature setpoint”.
A temperature value is shown. Enter the desired value with the operating button.
Setting range: -10 °C / 14 °F up to +100 °C / 212 °F.
Press the “Ok” button to confirm.

When entering a value outside the setting range, the message “invalid value” appears. Press the operating button to confirm with “Ok” and repeat the entry with a correct value.

10.3.3 Day of the week

Fixed value		08.03.2015 05:05:06		
..\ Temperature controller [°C]				
No.	Value	Day	H:M:S	Activity
1	25.00	Monday	00:00:00	Inactive

Week program editor.
Select a field under “Day” and press the operating button.



Fixed value		08.03.2015 05:05:06		
..\ Day of week				
Monday				
Tuesday				
Wednesday				
Thursday				
Friday				
Saturday				
Sunday				
Daily				
▼				
Close				

Submenu “Day of week”.
Select the desired day or combination of days and press the operating button.
Keep turning the operating button to access further menu items.

Fixed value 08.03.2015 05:05:06

..\ Day of week

Mon-Fri 

Sun-Thu

Mon-Sat

Fri+Sat

Sat+Sun

Close

Submenu "Settings" (next page).
Select the desired function
and press the operating button.

10.3.4 Time of the day

Fixed value 08.03.2015 05:05:06

..\ Temperature controller [°C]

No.	Value	Day	H:M:S	Activity
1	25.00	Monday	00:00:00	Inactive

Week program editor.
Select a value under "H:M:S"
and press the operating button.



Fixed value 08.03.2015 05:05:06

..\ Time of day

00:00:00

◀ Ins Pos1 End Ok 0 1 2 3 4 5 6 7 8 9 ▶

Close Ok

Entry menu "Time of day".
Enter the desired moment of the shift-point with the
operating button.
Press the "Ok" button to confirm.

10.3.5 Activity of the shift-point

Fixed value				08.03.2015 05:05:06
..\ Temperature controller				[°C]
No.	Value	Day	H:M:S	Activity
1	25.00	Monday	00:00:00	Inactive

Week program editor.
Select a field under “Activity”
and press the operating button.



Fixed value				08.03.2015 05:05:06
..\ Activity				
Inactive				
Active				
Close				

Submenu “Activity”.
Select the desired function
and press the operating button.

10.3.6 Switching on or off the optional zero-voltage relay outputs

Fixed value				08.03.2015 05:05:06
..\ Temperature controller				[°C]
No.	Value	Day	H:M:S	Activity
1	25.00	Monday	00:00:00	Inactive

Week program editor
(view with optional control outputs)
Select a field under “”
and press the operating button.



Fixed value				08.03.2015 05:05:06
..\ Zero -voltage relay outputs				
Outputs 1 [Off] 2[Off] 3[Off]				
Outputs 1[On] 2[Off] 3[Off]				
Outputs 1[Off] 2[On] 3[Off]				
Outputs 1[On] 2[On] 3[Off]				
Outputs 1[Off] 2[Off] 3[On]				
Outputs 1[On] 2[Off] 3[On]				
Outputs 1[Off] 2[On] 3[On]				
Outputs 1[On] 2[On] 3[On]				
Close				

Submenu “Zero -voltage relay outputs”.
The possible combination of switching states are
indicated.
Select the desired combination of switching states
and press the operating button.
[On] = zero-voltage relay outputs turned on
[Off] = zero-voltage relay outputs turned off



A symbol on the controller display indicates the switching state of the three zero-voltage relay outputs as soon as at least one output is switched on (example: outputs 1 + 2 turned on)

10.3.7 Calling up the next parameter

Fixed value		08.03.2015 05:05:06		
..\ Temperature controller				
No.	Value	Day	H:M:S	Activity
1	35.00	Monday	08:00:00	Active
2	40.00	Monday	10:00:00	Active
3	35.00	Monday	18:00:00	Active
4	10.00	Monday	20:00:00	Active
5	35.00	Tuesday	08:00:00	Active
6	40.00	Tuesday	10:00:00	Active
7	35.00	Tuesday	18:00:00	Active
8	10.00	Tuesday	20:00:00	Active
		Menu		

Week program editor (example).
Press the "Menu" button.

Fixed value		08.03.2015 05:05:06		
..\ Program menu				
Select parameter				
Save and exit				
Save and run				
Exit (without saving!)				
Close				

Submenu "Program menu".
Select "Select parameter"
and press the operating button.



With the „Close“ button, The controller returns to the week program editor.

Fixed value		08.03.2015 05:05:06		
..\ Program parameters				
Temperature controller				
Fan speed				
Close				

Submenu "Program parameters".
Select "Fan speed"
and press the operating button.

Entering the set-point values for another parameter (fan speed)

The number of program lines (program sections) equal to the number in the temperature program is displayed. The settings of the shift points (day, time, activity) are taken over from the temperature program; they are no editable in this view. You can enter the fan speed set-points.

 If you want to insert further sections or perform any other programming, first change back to the temperature program through *Menu > Select parameter > Temperature controller*.

Fixed value 08.03.2015 05:05:06				
..\ Fan speed [%]				
No.	Value	Day	H:M:S	Activity
1	100.00	Monday	10:00:00	Active
1	100.00	Monday	12:00:00	Active
1	100.00	Monday	00:00:00	Inactive
▲		Menu	▼	

Week program editor (example).

Entering the fan speed setpoint

Fixed value 08.03.2015 05:05:06				
..\ Fan speed [%]				
No.	Value	Day	H:M:S	Activity
1	100.00	Monday	00:00:00	Inactive

Week program editor.
Select a value under "Value" and press the operating button.



Fixed value 08.03.2015 05:05:06	
..\ Fan setpoint	
100	[%]
◀ Pos1 End Ok 0	1 2 3 4 5 6 7 8 9 ▶
Close	Ok

Entry menu "Fan setpoint".
A fan speed value is shown. Enter the desired value with the operating button.
Setting range: 40 % up to 100 %
Press the "Ok" button to confirm.

When entering a value outside the setting range, the message "invalid value" appears. Press the operating button to confirm with "Ok" and repeat the entry with a correct value.

10.3.8 Saving the week program and leaving the program editor

Fixed value		08.03.2015 05:05:06		
..\ Temperature setpoint				[°C]
No.	Value	Day	H:M:S	Activity
1	35.00	Monday	08:00:00	Active
2	40.00	Monday	10:00:00	Active
3	35.00	Monday	18:00:00	Active
4	10.00	Monday	20:00:00	Active
5	35.00	Tuesday	08:00:00	Active
6	40.00	Tuesday	10:00:00	Active
7	35.00	Tuesday	18:00:00	Active
8	10.00	Tuesday	20:00:00	Active

Week program editor (example).
Press the “Menu” button.

Fixed value		08.03.2015 05:05:06		
..\ Program menu				
Select parameter				
Save and exit				
Save and run				
Exit (without saving!)				
Close				

Submenu “Program menu”.
Select the desired function
and press the operating button.

With the „Close“ button, The controller returns to the week program editor.

Select parameter	Changing between temperature and fan speed.
Save and exit	Saving the program. The controller returns to the “Week programs” submenu. You can now select and start the week program as described in chap. 10.1.
Save and run	Saving the program and start it. Enter the start date and time, see chap. 10.1. If another time or week program is running, the program is only saved, but not started. A corresponding message is displayed.
Exit (without saving!)	Attention: the program is not saved. After a security question the controller returns to the initial view.
Button „Close“	The controller returns to the week program editor. You can continue programming.



Make sure that you saved the week program before leaving the program editor.

With “Exit (without saving!)” you exit the program editor without saving the program. There is a security question first:

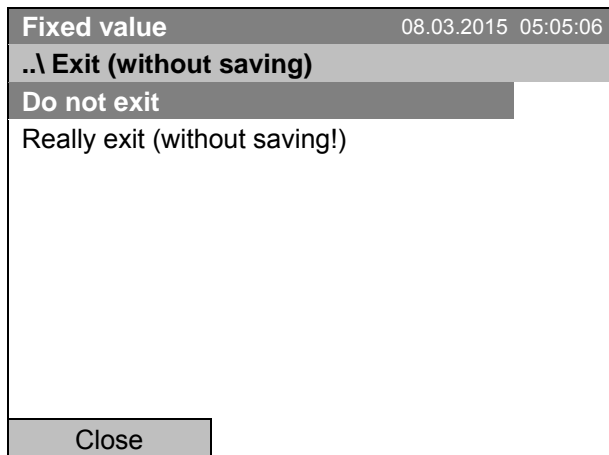

Submenu “Exit (without saving)”.

This a security question. Select the desired function and press the operating button.

Then there is an additional security question. Select the desired function and press the operating button.

If you selected “Really exit (without saving!)”, the controller goes back to the initial view.

10.4 Deleting a week program

To delete a week program, go to [Menu > Programs > Week program > Delete](#) or [Menu > Programs > Week program > Delete all](#)

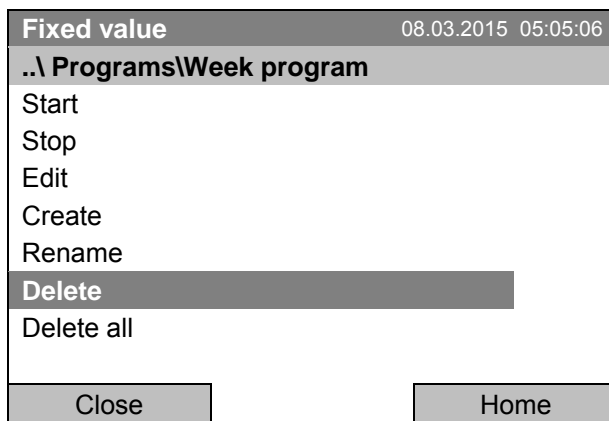

Submenu “Week program”.

Select “Delete” or “Delete all” and press the operating button.

If you selected “Delete”, select then the week program to be deleted and press the operating button.

If you selected “Delete all”, all week programs will be deleted in the controller.

Before deleting there is a security question:

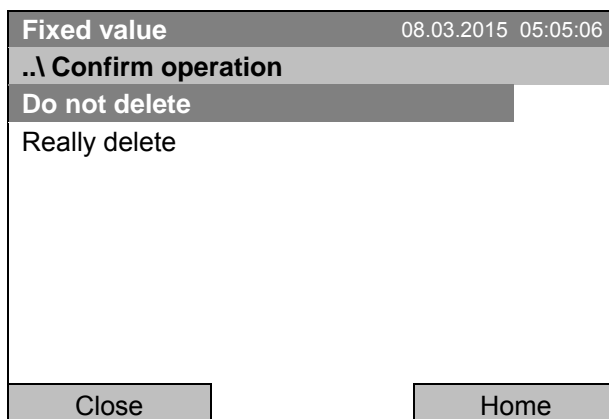

Submenu “Confirm operation”.

This a security question. Select the desired function and press the operating button.

Go back to the initial view with “Home”.

11. Key lock

The key lock function serves to block the access to the controller. When the “key lock” is activated, the controller remains in the actual view and can only be changed when entering the current password.

To configure the key lock function, go to [User > Key lock](#)

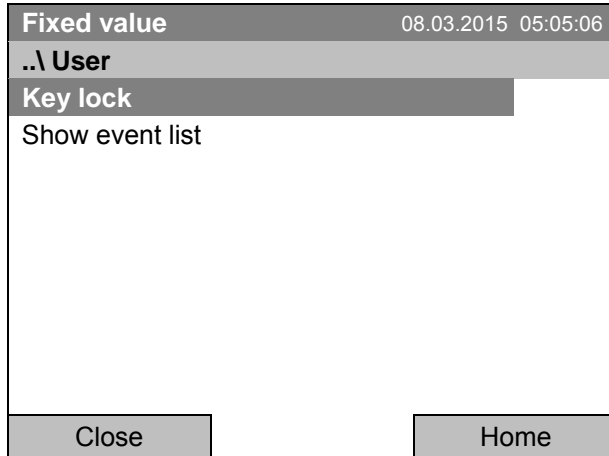

“User” menu.
Select “Key lock”
and press the operating button.

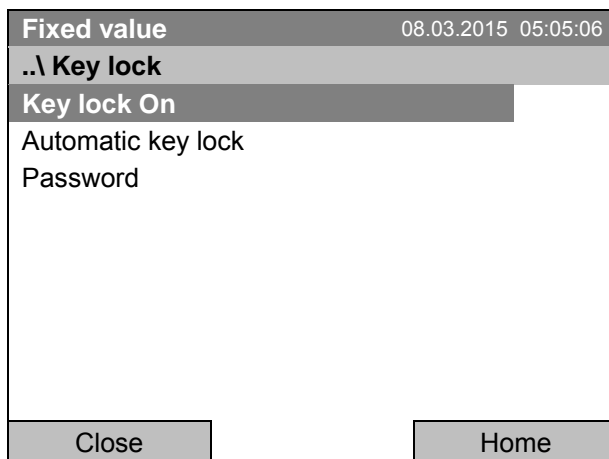

Submenu “Key lock”.
Select the desired function
and press the operating button.

Key lock On	The key lock is directly activated
Automatic key lock	The key lock is activated automatically after a defined waiting time
Password	Change password for unlocking. Factory setting: 0000

11.1 Directly activating the key lock function

To directly activate the key lock, go to [User > Key lock > Key lock On](#)

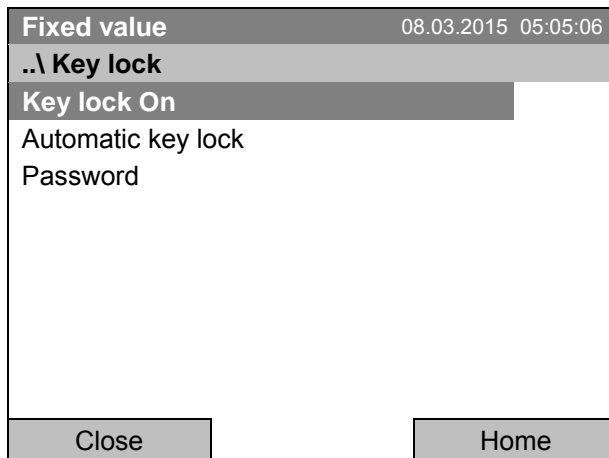

Submenu "Key lock".

Select "Key lock On" to activate the key lock function immediately and press the operating button.

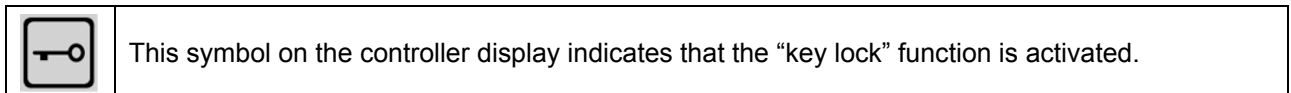

The controller remains in the initial view and may be operated only after entering the current password.

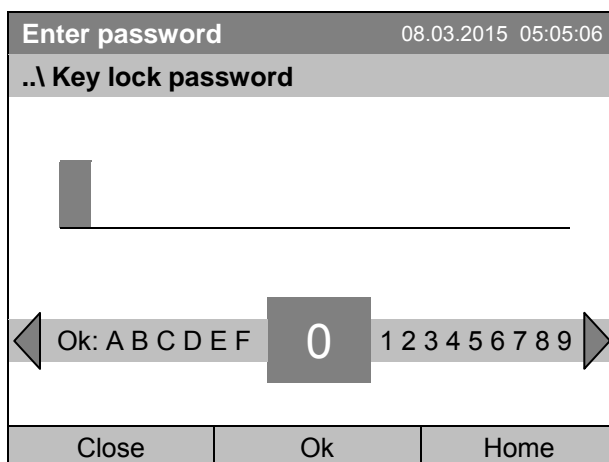

Entry menu "Key lock password".

Enter the desired password with the operating button. Factory setting is 0000

Press the "Ok" button to confirm.

11.2 Automatic key lock

To configure the automatic key lock, go to [User > Key lock > Automatic key lock](#)

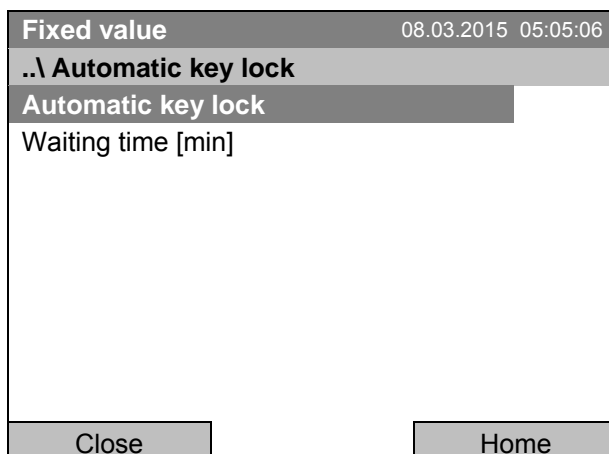

Submenu "Automatic Key lock".

Select the desired function and press the operating button.

Under “Waiting time [min]” you can enter the waiting time, after which the key lock will be automatically activated. This time starts running off after the last entry to the controller. To enter it, go to [User > Key lock > Automatic key lock > Waiting time \[min\]](#)

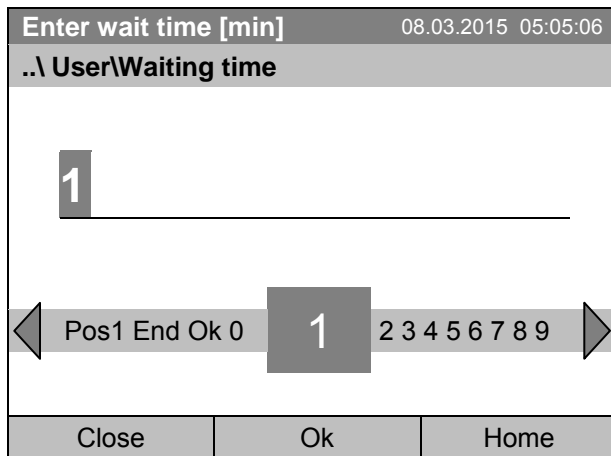

Entry menu “Waiting time”.

Enter the desired interval with the operating button. This interval starts running off after the last action on the controller. If the automatic key lock function is enabled, it will become active after this time.

Factory setting: 1 minute.

Press the “Ok” button to confirm.

To activate the automatic key lock function with the pre-configured waiting time, select [User > Key lock > Automatic key lock > Automatic key lock](#)

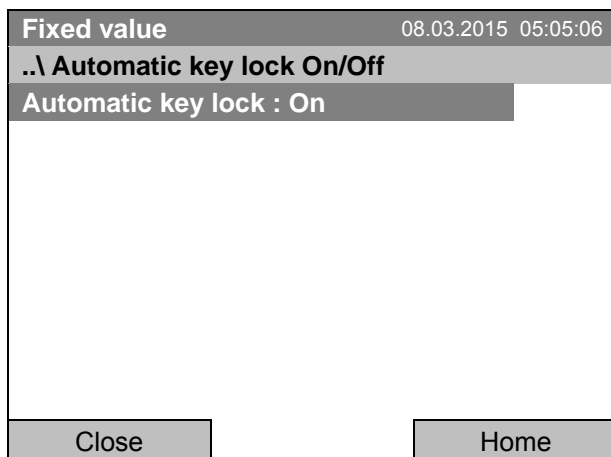

Submenu “Automatic Key lock On/Off”.

The current setting is displayed.

To change the setting, press the operating button.

„Automatic Key lock : On“ = Automatic key lock function activated. The time set under „Waiting time“ begins running off..

„Automatic Key lock : Off“ = Automatic key lock function deactivated

Now the waiting time starts running off.

Go back to the initial view with “Home”.

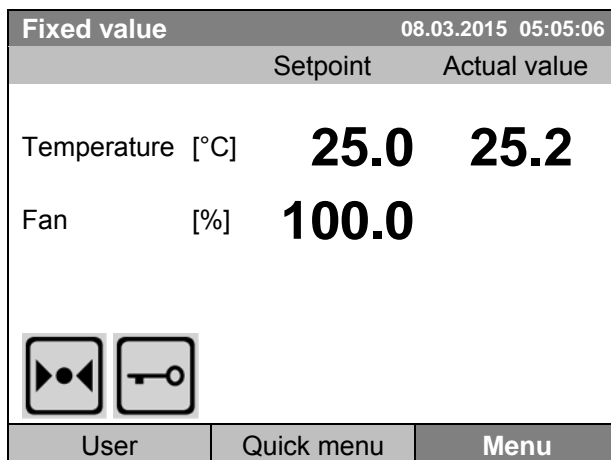

Initial view.

As soon as the waiting period has expired, the “key lock” symbol is displayed.

The controller remains in the initial view and may be operated only after entering the current password.

After further entries to the controller, the waiting period begins running again, since the automatic keylock function remains active until turning it off manually.



This symbol on the controller display indicates that the “key lock” function is activated.

11.3 Changing the password for unlocking the key lock

To change the password for unlocking the key lock, go to *User > Key lock > Password*

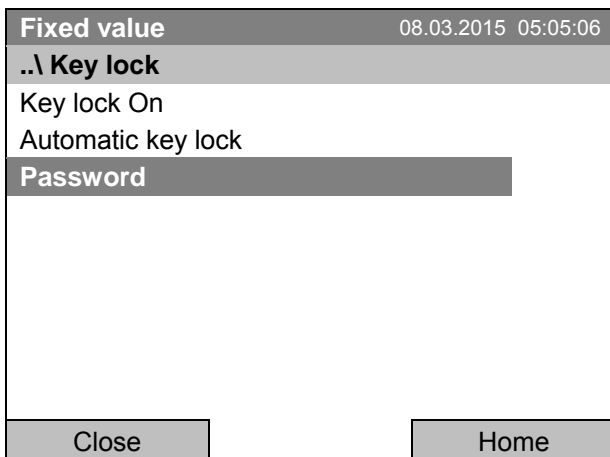

Submenu “Key lock”.
Select “Password”
and press the operating button.

A security question is displayed:

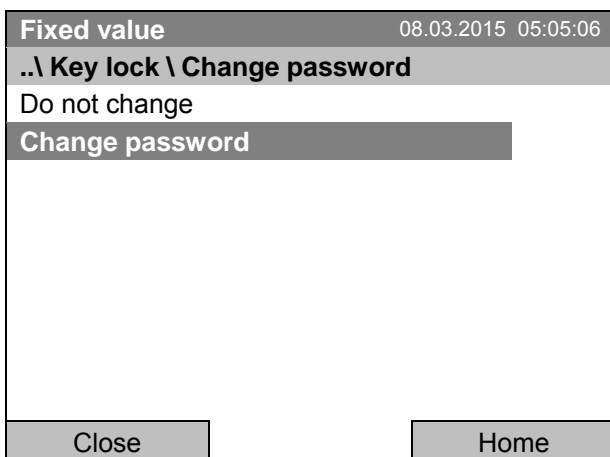

Submenu “Change password”.
To change the password,
select “Change password”
and press the operating button.

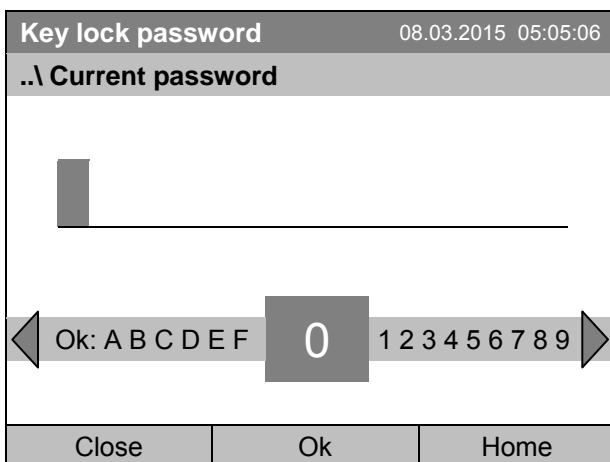

Entry menu “Current password”.
Enter the desired password with the operating button. Factory setting is 0000
Press the “Ok” button to confirm.



Keep well in mind any password modification. Without the correct password, unlocking the key lock is impossible.

12. General controller settings

In the "Settings" submenu, you can enter the date and time, select the language for the menus and the desired temperature unit, perform the configuration for the controller's communication functions, and reset the controller to factory settings.

To access the "Settings" submenu, go to [Menu > Settings](#)

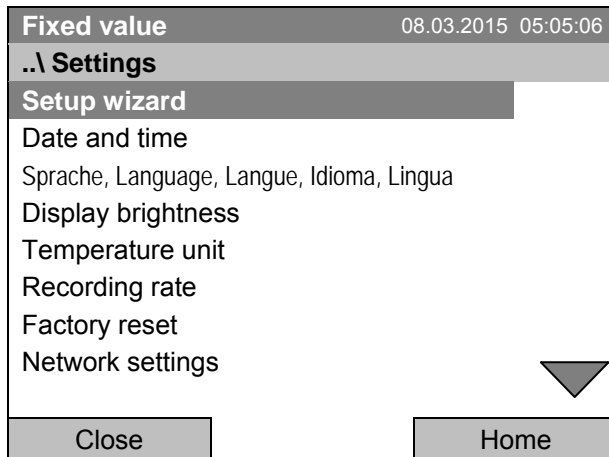

Submenu "Settings".
Turn the operating button to see additional menu items.

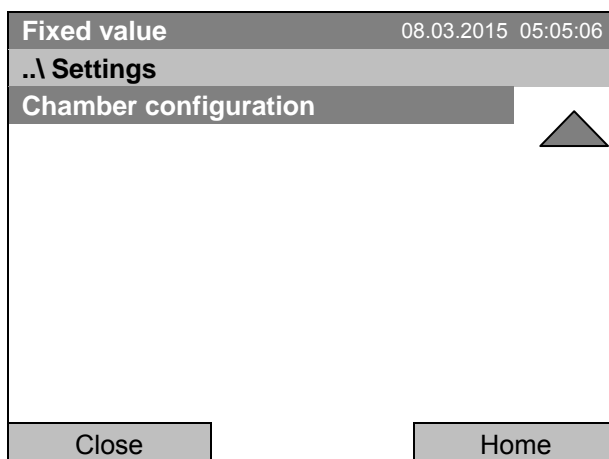

Submenu "Settings" (next page)..

Setup wizard	Chap. 12.1
Date and time	Setting date and time, chap. 12.2
Sprache, Language, Langue, Idioma, Lingua	Selecting the controller's menu language, chap. 12.3
Display brightness	Adjusting display brightness by turning the operating button
Temperature unit	Selecting the temperature unit, chap. 12.5
Recording rate	Defining the recording rate for data storage, chap. 12.6
Factory reset	Factory reset, chap. 12.7
Network settings	Network configuration, chap. 12.8
Chamber configuration	Menu for service purpose – Display and entry of chamber data (serial no., special application no., option object temperature, chap. 12.10

12.1 Setup wizard

The setup wizard will guide you sequentially through the important menus to configure your chamber

- Menu language
- Chamber name
- Date and time
- IP address
- Subnet mask
- Network name
- Gateway
- DNS 1
- DNS 2

Then the controller returns to the initial view.

	Use the setup wizard only if you want to enter all the requested information, as no item can be skipped.
---	--

	You can configure the network settings (IP address, and the following) only if the DHCP status is Off, otherwise the DHCP server would assign the network configuration.
---	--

If you try configuring any network settings while DHCP is enabled, (i.e. settings from menu item "IP Address" on in the setup wizard), the message "DHCP enabled!" is shown. After confirming with Ok the Setup wizard is cancelled and the controller returns to the initial display. The settings made up to then remain effective.

12.2 Date and time settings

To access the date and time settings, go to [Menu > Settings > Date and time](#)

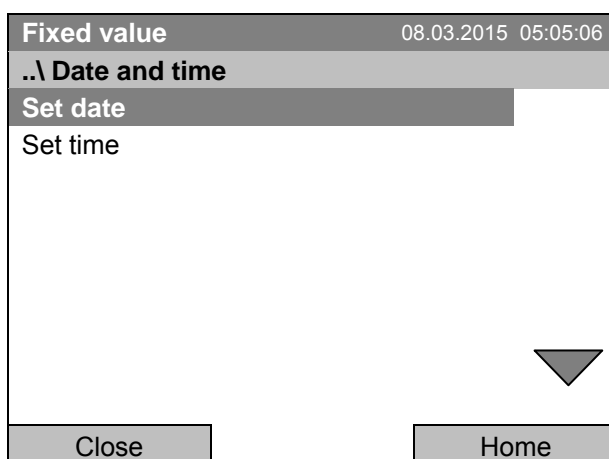

Submenu "Date and time".
Select the desired function
and press the operating button.

Function "Set date"

Fixed value		08.03.2015 05:05:06	
..\ Select date (DD.MM.YYYY)			
08.03.2015			
◀	Ins Pos1 End Ok	0	▶ 1 2 3 4 5 6 7 8 9
Close	Ok	Home	

Entry menu "Select date".

The current date is shown. If it is incorrect, enter the correct date with the operating button.

Press the "Ok" button to confirm.

Function "Set time"

Fixed value		08.03.2015 05:05:06	
..\ Set time (HH:MM:SS)			
05:05:06			
◀	Ins Pos1 End Ok	0	▶ 1 2 3 4 5 6 7 8 9
Close	Ok	Home	

Entry menu "Set time".

The current time is shown. If it is incorrect, enter the correct time with the operating button.

Press the "Ok" button to confirm.

There is no automatic switch to local light-saving times because this could lead to problems with data seeming to be missing or being overwritten in the data base.

Go back to the "Settings" menu with "Close" or to the initial view with "Home".

12.3 Selecting the menu language of the T4.12 controller

The T4.12 chamber controller communicates via a comprehensible menu navigation in plain text in a selectable language.

To select the desired menu language, go to

Menu > Settings > Sprache, Language, Langue, Idioma, Lingua

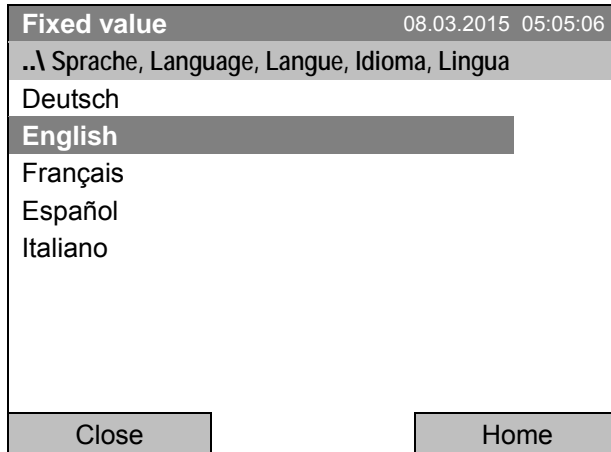

Submenu "Language".
Select the desired language and press the operating button.

If you selected the menu language, the controller returns to the „Settings“ menu..

Otherwise, go back to the "Settings" menu with "Close" or to the initial view with "Home".

12.4 Setting display brightness

To select the display brightness, go to **Menu > Settings > Display brightness**

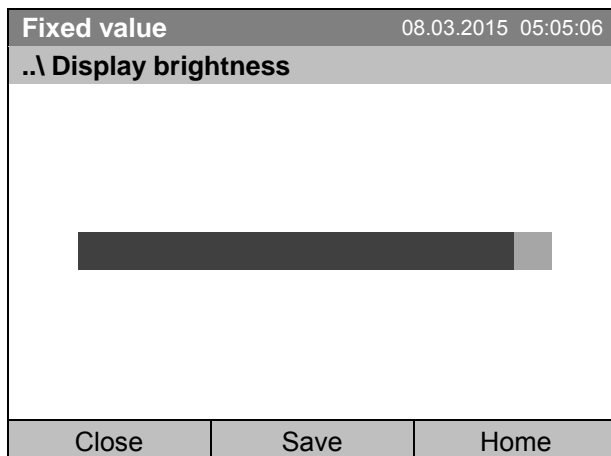

Submenu "Display brightness".
Select the desired setting by turning the operating button.
Confirm by selecting "Save".

Go back to the "Settings" menu with "Close" or confirm the change with "Save": The controller returns to the initial view.

12.5 Changing the temperature unit

To select the temperature unit, go to [Menu > Settings > Temperature unit](#)

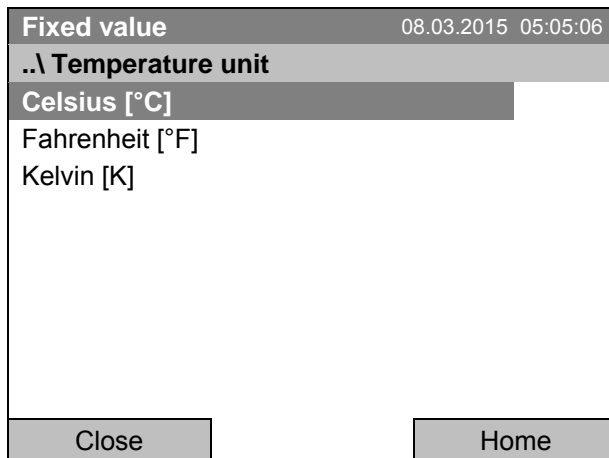

Submenu "Temperature unit".
Select the desired temperature unit
and press the operating button.

If you selected the temperature unit, the controller returns to the „Settings“ menu..

Otherwise, go back to the "Settings" menu with "Close" or to the initial view with "Home".

12.6 Defining the data recording rate

To define the recording rate for data storage on the SD card, go to [Menu > Settings > Recording rate](#)

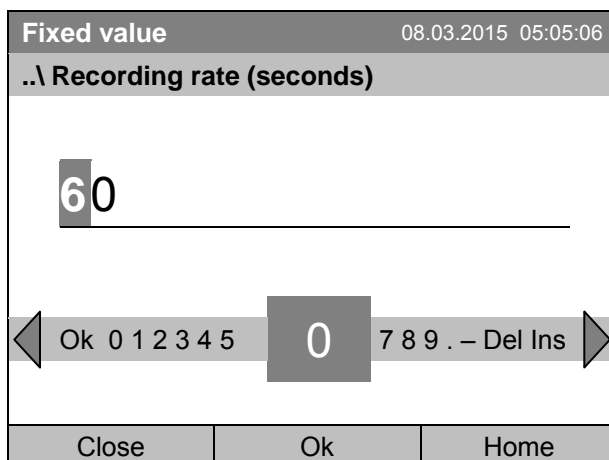

Entry menu "Recording rate".
The current recording rate is shown. Enter the de-
sired value with the operating button.
Shortest possible value: 60 seconds.
Press the "Ok" button to confirm.

When entering a value smaller than 60 seconds, the message "invalid value" appears. Press the operat-
ing button to confirm with "Ok" and repeat the entry with a correct value.

Go back to the "Settings" menu with "Close" or to the initial view with "Home".

Note:

After a period of 9 years, the controller starts overwriting the oldest values on the storage medium. This is independent of the selected storage interval and the actual operating time of the chamber. In any case, the data can be read out at any time using the function "Export to USB drive" (chap. 13.1) and stored externally.

12.7 Factory reset

The “factory reset” function allows resetting the controller configuration to the factory settings.

	<p>Risk of data loss! When resetting to factory settings, all controller settings, user data and passwords, will be deleted. Any entered programs, the event list and stored measuring data are NOT affected.</p>
---	--

To access the “Factory reset” function, go to [Menu > Settings > Factory reset](#)

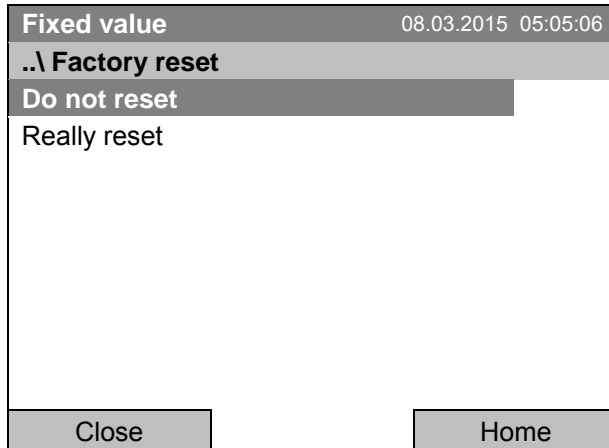

Submenu “Factory reset”.

This a security question. Select the desired function and press the operating button.

If you selected “Really reset” a message asking to restart the chamber appears. Confirm with “OK”. The controller returns to the initial view.

Otherwise, go back to the “Settings” menu with “Close” or to the initial view choosing “Do not reset” or “Home”.

12.8 Network configuration

The settings of this submenu are required for networking chambers with an Ethernet interface, e.g. to connect them with BINDER’s communication software APT-COM™ 3 DataControlSystem.

You can display the chamber’s IP address that has been assigned by your DHCP server or manually assign the IP address. All necessary configurations for networking the chamber are available in this menu.

To view and configure the network settings, go to [Menu > Settings > Network settings](#)

	<p>To configure the network settings, the DHCP state must be set to off. Otherwise, the DHCP-server would assign the network configuration.</p>
---	---

If you try to configure the network settings with enabled DHCP state, the message “DHCP enabled!” is shown. Confirm with „Ok” to return to the “Network settings” menu.

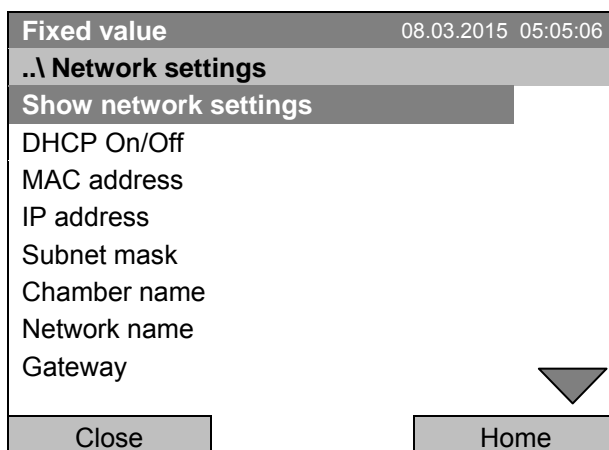

Submenu “Network settings”.

Turn the operating button to see additional menu items.

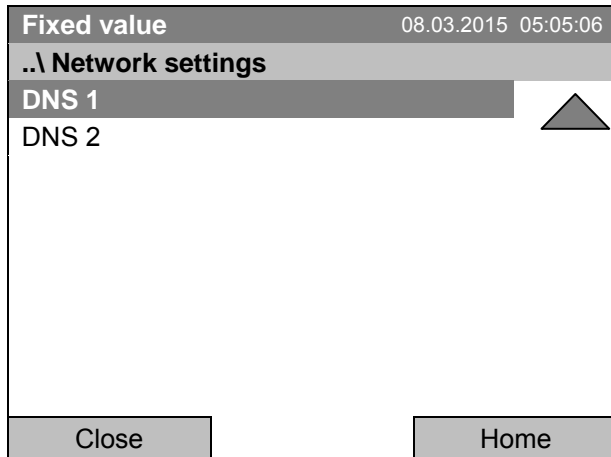

Submenu "Network settings" (next page).

Show network settings	Overview of the entire network configuration
DHCP on/off	Switching on and off the DHCP state
MAC address	Display of the chamber's MAC address
IP address	Entering the desired IP address
Subnet mask	Entering the subnet mask number
Chamber name	Entering the name of the cooling incubator
Network name	Entering the network name
Gateway	Entering the gateway number
DNS 1	Entering the DNS 1 number
DNS 2	Entering the DNS 2 number

Set the DHCP State on/off:

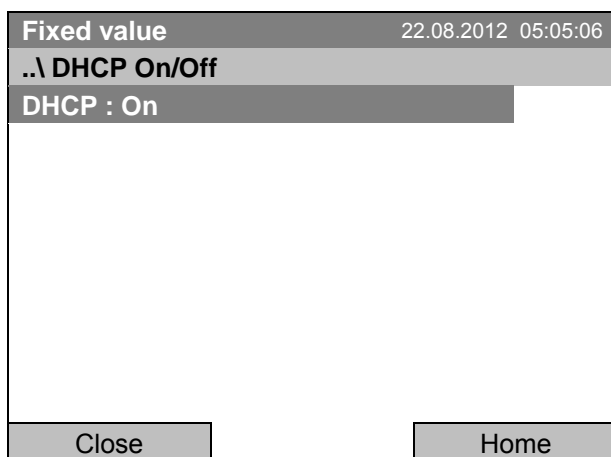

Submenu "DHCP On/Off".

The current DHCP state is displayed. Press the operating button to change it.

Then the new DHCP state is displayed

"DHCP : On" = DHCP state activated

"DHCP : Off" = DHCP state deactivated

Go back to the "Network settings" menu with "Close" or to the initial view with "Home".



You can only configure the following network settings if the DHCP state is set to "Off".

Display the MAC address

To identify the chamber in the Ethernet network you can display the chamber's MAC address.

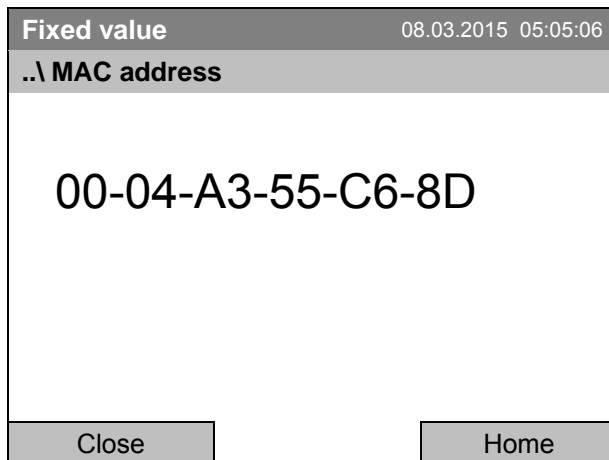

Submenu "MAC address"
(example value)
The MAC address is displayed.

Go back to the "Network settings" menu with "Close" or to the initial view with "Home".

Enter the IP address:

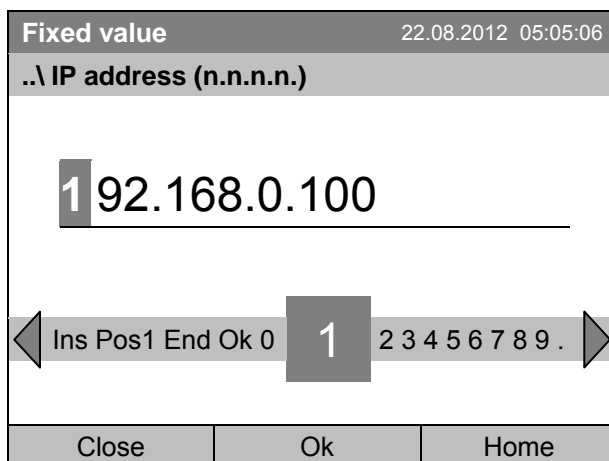

Entry menu "IP address"
(example value)
Enter the desired IP address with the operating button.
Press the "Ok" button to confirm.

Go back to the "Network settings" menu with "Close" or to the initial view with "Home".

Enter the subnet mask:

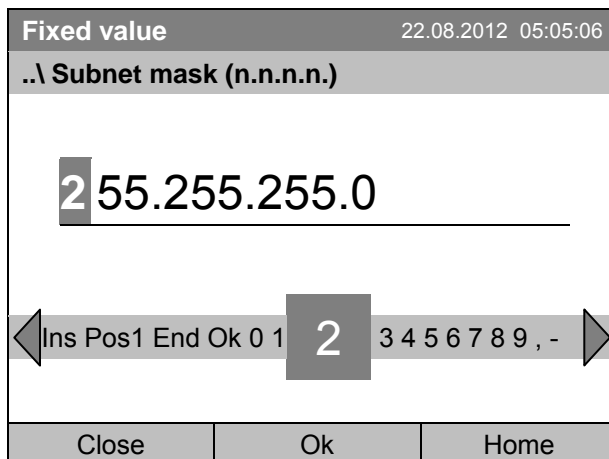

Entry menu "Subnet mask"
(example value)
Enter the desired net mask with the operating button.
Press the "Ok" button to confirm.

Go back to the "Network settings" menu with "Close" or to the initial view with "Home".

Enter the chamber name:

Fixed value		22.08.2012 05:05:06
..\ Chamber name		
KB_E6		
◀	C D E F G H I J	K
		L M N O P Q R ▶
Close	Ok	Home

Entry menu "Chamber name"
(example)

Enter the desired chamber name with the operating button.

Press the "Ok" button to confirm.

Go back to the "Network settings" menu with "Close" or to the initial view with "Home".

Enter the network name:

Fixed value		22.08.2012 05:05:06
..\ Network name		
KB_E6		
◀	C D E F G H I J	K
		L M N O P Q R ▶
Close	Ok	Home

Entry menu "Network name"
(example)

Enter the desired network name with the operating button.

Press the "Ok" button to confirm.

Go back to the "Network settings" menu with "Close" or to the initial view with "Home".

Enter the default gateway:

Fixed value		22.08.2012 05:05:06
..\ Gateway (n.n.n.n.)		
192.168.0.1		
◀	Pos1 End Ok 0	1
		2 3 4 5 6 7 8 9 , ▶
Close	Ok	Home

Entry menu "Gateway"
(example value)

Enter the desired gateway with the operating button.

Press the "Ok" button to confirm.

Go back to the "Network settings" menu with "Close" or to the initial view with "Home".

Enter the DNS 1 or DNS 2:

Fixed value		22.08.2012 05:05:06
..\ DNS 1 (n.n.n.n.)		
1 192.168.0.1		
◀	Ins Pos1 End Ok 0	1 2 3 4 5 6 7 8 9 , ▶
Close	Ok	Home

Entry menu “DNS 1” or “DNS 2”
(example value)
Enter the desired number with the operating button.
Press the “Ok” button to confirm.

Go back to the “Network settings” menu with “Close” or to the initial view with “Home”.

12.9 Display of the entire network configuration

To access the overview of the complete network configuration, go to
[Menu > Settings > Network settings > Show network settings](#)

Fixed value		08.03.2015 05:05:06
..\ Show network settings		
DHCP	Off	
MAC address	00-04-A3-55-C6-8D	
IP address	192.168.0.100	
Net mask	255.255.255.0	
Gateway	192.168.0.1	
DNS1	192.168.0.1	
DNS2	0.0.0.0	
Chamber name	KB_E6	
BIOS name	KB_E6	
Close		Home

Overview of the network configuration
(sample values)

Go back to the “Network settings” menu with “Close” or to the initial view with “Home”.

12.10 Display and entry of the chamber configuration – for service purpose

Information about the chamber, such as chamber type, name, serial number, firmware version, etc. can be viewed under [Menu > System information](#) (chap. 6.4).

To access the device configuration menu, go to [Menu > Settings > Chamber configuration](#)

This menu is password protected and only intended for service purposes.

13. Data transfer via USB interface

The USB port is located in the instrument box.

To access the submenus for data transfer, go to [Menu > Import/Export](#)

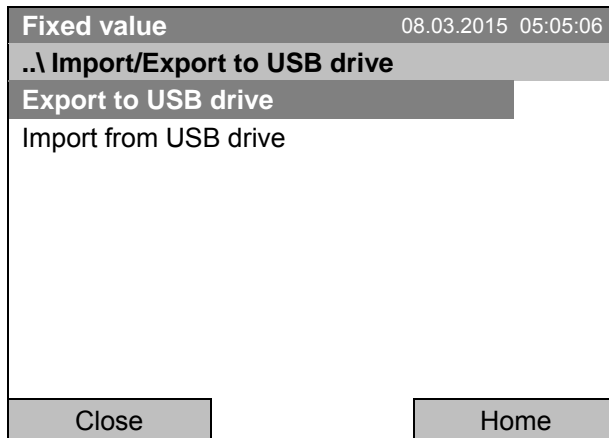

Submenu “Import/Export to USB drive”.
Select the desired type of communication via USB port (data export or import) and press the operating button.



It is possible that some USB devices are not recognized due to compatibility issues. In this case, please use a USB storage device from a different manufacturer.

13.1 Exporting data to USB drive

Insert the USB stick or the plug of your USB drive into the USB port in the instrument box.

To configure data export to USB media, go to [Menu > Import/Export > Export to USB drive](#)

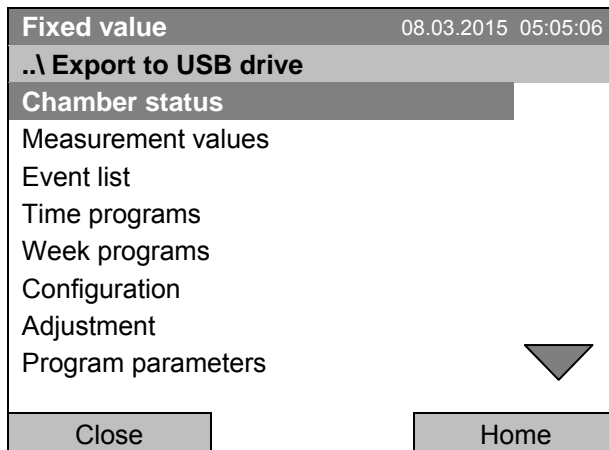

Submenu “Export to USB drive”.
Turn the operating button to see additional menu items.

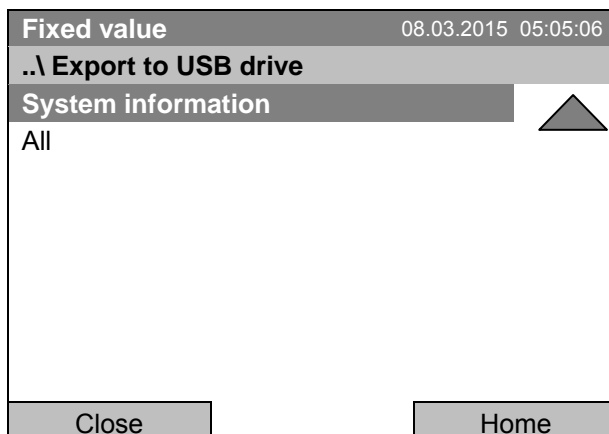

Submenu “Export to USB drive” (next page)

Select the desired data type and press the operating button. Data will be written to the connected media.

Chamber status	Actual chamber status, including operating mode, set-points etc.
Measurement values	Measured data
Event list	List of status information and errors (see chap. 15)
Time programs	All stored time programs
Week programs	All stored week programs
Configuration	(Service only)
Adjustment	Adjustment data
Program parameters	(Service only)
System information	(Service only)
All	All data

	If no USB device has been connected, the message “No USB device found” is displayed. It disappears after inserting the USB stick or the plug of your USB drive into the USB port in the instrument box.
---	---

	This symbol on the controller display indicates that data are being transmitted via the USB port.
--	---

13.2 Importing data from USB drive

Insert the USB stick or the plug of your USB drive into the USB port in the instrument box.

To configure data import from USB media, go to [Menu > Import/Export > Import from USB drive](#)

Fixed value	08.03.2015 05:05:06
..\ Import from USB drive	
All time programs	
All week programs	
Configuration	
Firmware	
Close	Home

Submenu “Import from USB drive”.

Select the desired data type and press the operating button. Data will be imported from the connected media.











All time programs	All stored time programs
All week programs	All stored week programs
Configuration	(Service only)
Firmware	(Service only)

	If no USB device has been connected, the message “No USB device found” is displayed. It disappears after inserting the USB stick or the plug of your USB drive into the USB port in the instrument box.
---	---





	This symbol on the controller display indicates that data are being transmitted via the USB port.
---	---

14. Notifications and Alarms

14.1 Notifications overview

Icon	Signification		Icon	Signification
	Fixed value operation	Operating modes		Heating active
	Time program operation			Door heating active (KB / KB-UL 240 / 400 / 720)
	Time program interrupted			Refrigeration active
	Week program operation			Key lock activated
	Interior socket (option) turned on			Copying data via USB
			Switching state of the optional zero-voltage relay control outputs (example: control outputs 1 + 2 switched on)	

14.2 Alarms overview

Icon	Alarm message	Signification
	Safety controller overtemperature	Overtemperature safety controller alarm (class 3.1): selected value of the safety controller exceeded
	Safety controller overtemperature	Overtemperature safety controller alarm with option class 3.3: selected value of the safety controller exceeded
	Safety controller undertemperature	Undertemperature safety controller alarm with option class 3.3: fallen below selected value of the safety controller
	Temp. range	Tolerance range alarm: Having reached the set-point, the temperature deviates by more than +/- 2 °C from the set-point for more than 10 minutes, or the temperature doesn't reach the tolerance range within 3 hours from turning on the chamber or closing the door

You can activate / deactivate the buzzer in the “Alarms” submenu (chap. 14.5.3).

With an activated buzzer there is an **audible alert** with an alarm. You can reset it in the “Alarms” submenu for alarm acknowledgement pressing the “Reset” button (chap. 14.4). The alarm symbol will only disappear when the cause of the alarm has been remedied.

An optional **zero-voltage relay alarm contact for temperature** (chap. 19.5) is available. It is activated in case of the alarm messages with temperature deviations) as well as in case of a power failure and when turning off the main power switch.

For appropriate actions in the event of an alarm, please refer to chap. 22 “Troubleshooting”.

14.3 Alarm status

An alarm message can appear in 3 different states:

Status “set”

- Active alarm.
- The corresponding alarm icon is displayed in the initial view The buzzer sounds (if activated).
- The “Info” button in the initial view leads to the “Alarms” submenu for alarm acknowledgement.
- Press the “Reset” button in the “Alarms” submenu for alarm acknowledgement to mute the buzzer and confirm the alarm.



Status “acknowledged”

- Active alarm.
- The alarm was acknowledged.. The buzzer is off.
- The alarm cause is still valid. Therefore, the alarm icon remains displayed in the initial view.
- The alarm message figures in the list of active alarms.

Status “cleared”

- The alarm cause has disappeared.
- The alarm icon is not displayed any longer
- The alarm message has disappeared from the list of active alarms.
- The alarm message remains in the Event list for information.

14.4 Confirming a “set” alarm

Fixed value		08.03.2015 15:05:02	
	Setpoint	Actual value	
Temperature [°C]	25.0	29.8	
Fan [%]	100.0		
  			
User	Info	Menu	

Initial view with overtemperature safety controller alarm.
The buzzer sounds (if not deactivated previously).
Press the “Info” button.



Alarm acknowledgement		08.03.2015 05:05:06	
..\ Home/Alarms			
Safety controller overtemperature			
Close	Reset	Home	

Submenu “Alarms” for alarm acknowledgement.

Press the “Reset” button to confirm the alarm. If there is another active “set” alarm, you can also confirm it with the “Reset” button. After confirming all active “set” alarms, the buzzer is off, and the initial view is displayed.

As long as an alarm is still active, i.e. as long as the alarm cause is still valid, the alarm icon continues to be displayed in the initial view.

14.5 Alarm configuration and overview

To access the alarm lists and configuration menu, go to [Menu > Alarms](#)

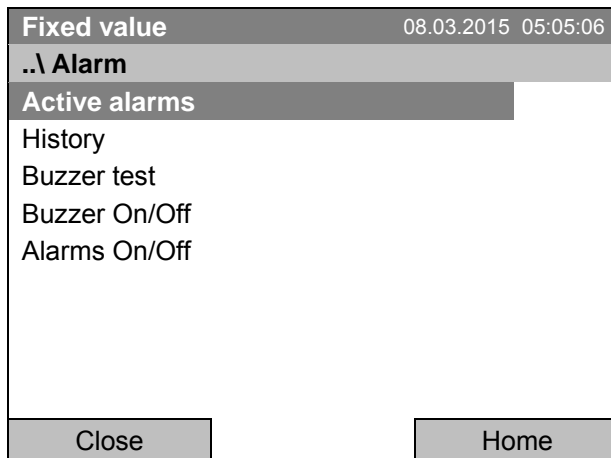

Submenu "Alarm".
Select the desired function
and press the operating button.

Active Alarms	List of the active alarms (status "set" or "acknowledged").
History	List of all alarms (status "set" or "acknowledged" or "cleared").
Buzzer test	Testing the alarm buzzer, chap. 14.5.3
Buzzer On/Off	Activating / deactivating the alarm buzzer, chap. 14.5.3
Alarms On/Off	Activating / deactivating the alarm functions. Off: Alarm buzzer off, no alarm icons displayed. No alarm messages will be displayed.

14.5.1 List of active alarms

To access the overview list of active alarms, go to [Menu > Alarms > Active alarms](#)

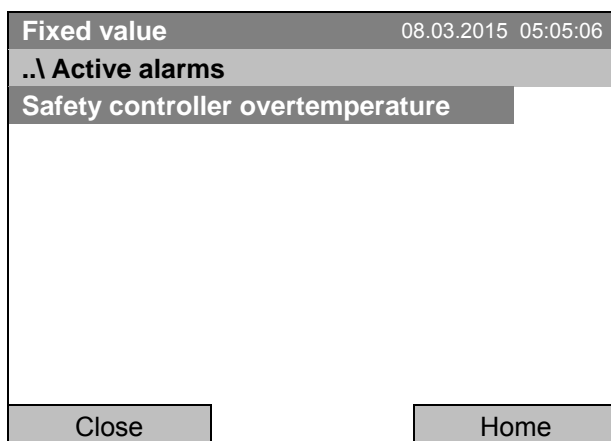

Submenu "Active alarms".
All active alarms with status "set" or "acknowledged",
are listed.

If no alarm is active ("set" or "acknowledged"), no message will be displayed in this window.

14.5.2 History – list of all alarms

To access the overview list of all alarms, go to [Menu > Alarms > History](#)

This list indicates the moment when an alarm was set and when cleared.

Fixed value		08.03.2015 15:05:06
..\ History		
08.03.2015 : Messages of indicated day		
14:39:48	Alarm set	Safety controller overtemperature
15:03:22	Alarm cleared	Safety controller overtemperature
Close		Home

Submenu “History” (example).

The list shows when the alarms of the current day were triggered and when cleared. The most recent message appears at the end of the list.

The information that an alarm has been acknowledged is shown in the event list.

When there is more information than one page, you can scroll the list in both directions with the operating button.

To select a different date, select “Messages of indicated day” and press the operating button. You can enter the desired date through an entry menu.

Fixed value		08.03.2015 05:05:06
..\ Select date (DD.MM.YYYY)		
08.03.2015		
◀	Ins Pos1 End Ok	0 1 2 3 4 5 6 7 8 9 ▶
Close	Ok	Home

Entry menu “Select date”.

The current date is shown. Enter the desired date with the operating button.

Press the “Ok” button to confirm.

The alarm list of the selected date is displayed.

The entire sequence of the alarm events (set – acknowledged – cleared) is shown in the event list (chap. 15).

To access the event list, go to [Menu > Event list](#) or [User > View event list](#)

Fixed value		08.03.2015 15:05:06
..\ Event list		
08.03.2015 : Messages of indicated day		
14:17:20	Fan setpoint	50.00
14:35:12	Fan setpoint	100.00
14:39:48	Alarm set	Safety controller overtemperature
14:40:19	Alarm acknowledged	Safety controller overtemperature
15:03:22	Alarm cleared	Safety controller overtemperature
Close		Home

Submenu “Event list” (example).

The events and alarm messages of the current day are displayed. The most recent message appears at the end of the list.

14.5.3 Activating, deactivating, and testing the alarm buzzer

Alarm buzzer test

To access the functional test of the alarm buzzer, go to [Menu > Alarms > Buzzer test](#)

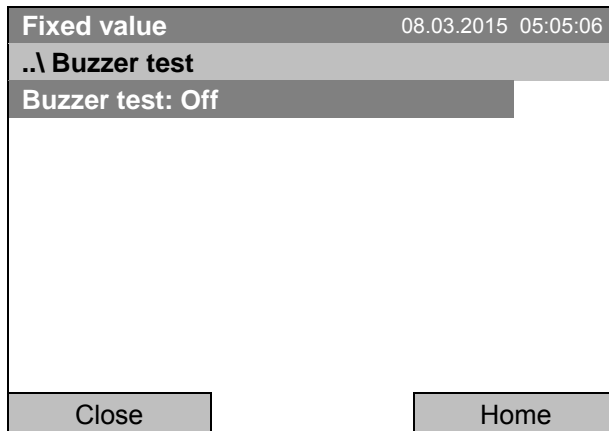

Submenu "Buzzer test".

The current setting is displayed.

Press the operating button to turn on or off the buzzer for test purpose.

The modified setting is displayed

"Buzzer test: On" = Buzzer turns on

"Buzzer test: Off" = Buzzer turns off

When turned on, the alarm buzzer emits an intermittent signal. To turn this off, change the test function to "Buzzer test: Off".

Activating / deactivating the alarm buzzer

To activate or deactivate the alarm buzzer, go to [Menu > Alarms > Buzzer On/Off](#)

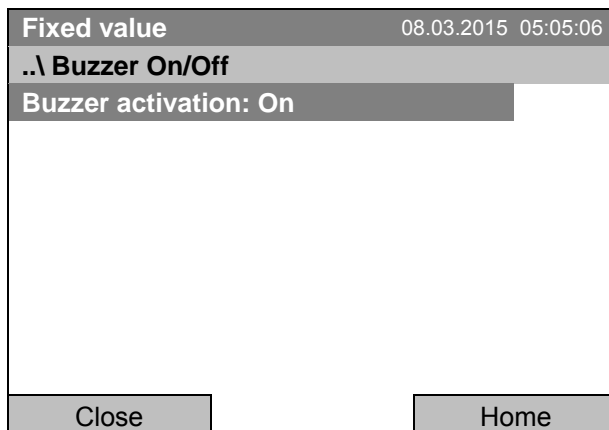

Submenu "Buzzer On/Off".

The current setting is displayed.

To change the setting, press the operating button.

The modified setting is displayed

"Buzzer activation: On" = Buzzer will turn on in the event of an alarm

"Buzzer activation: Off" = Buzzer is deactivated

14.5.4 Activating / deactivating all alarm functions

To access the alarm settings, go to [Menu > Alarms > Alarms On/Off](#)

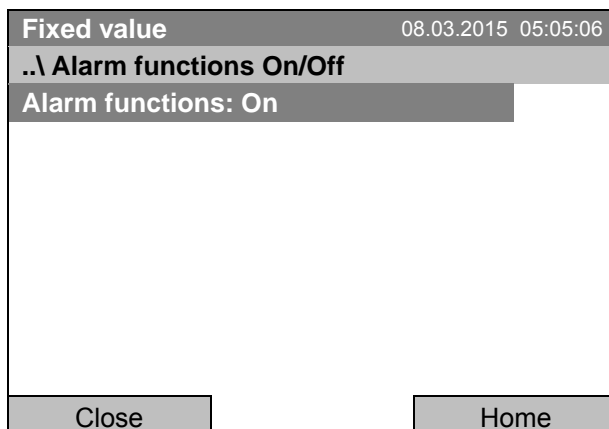

Submenu "Alarm functions On/Off".

The current setting is displayed.

To change the setting, press the operating button.

The modified setting is displayed

"Alarm functions: On" = The alarm functions of the controller are active

"Alarm functions: Off" = All alarm functions are deactivated

Go back to the initial view with "Home".

15. Event list

The “Event list” displays status information and errors of the current day. You can also access the events of past days.

To access the event list, go to *Menu > Event list* or *User > Show event list*

Fixed value		08.03.2015 15:05:06
..\ Event list		
10:11:49	Time program stopped	▲
10:11:59	Power supply was interrupted.	
10:12:05	Common controller mode OFF	
10:17:20	Common controller mode ON	
10:35:12	Fan setpoint 80.00	
11:04:12	Fan setpoint 100.00	
Close	Reset	Home

Submenu “Event list” (example).

The events of the current day are displayed. The most recent message appears at the end of the list.

To acknowledge an activated alarm, proceed as described in chap. 14.4.

Turn the operating button to see additional data.

Fixed value		08.03.2015 15:05:06
..\ Event list		
08.03.2015	Messages of indicated day	
09:01:59	User management disabled	
09:12:05	Language loaded	
09:17:20	Fan setpoint 80.00	
09:35:12	Fan setpoint 100.00	
10:04:12	New section time program	
10:06:46	Time program started	▼
Close	Reset	Home

Submenu “Event list” (example).

The events of the current day are displayed.

When there is more information than one page, you can scroll the event list in both directions with the operating button.

To select a different date, select “Messages of indicated day” and press the operating button. You can enter the desired date through an entry menu.

Fixed value		08.03.2015 05:05:06
..\ Select date (DD.MM.YYYY)		
08.03.2015		
◀	Ins Pos1 End Ok	0 1 2 3 4 5 6 7 8 9 ▶
Close	Ok	Home

Entry menu “Select date”.

The current date is shown. Enter the desired date with the operating button.

Press the “Ok” button to confirm.

The event list of the selected date is displayed.

16. Graphical display of the measured values

To access the graphical display, go to [Menu > Measurement chart](#)

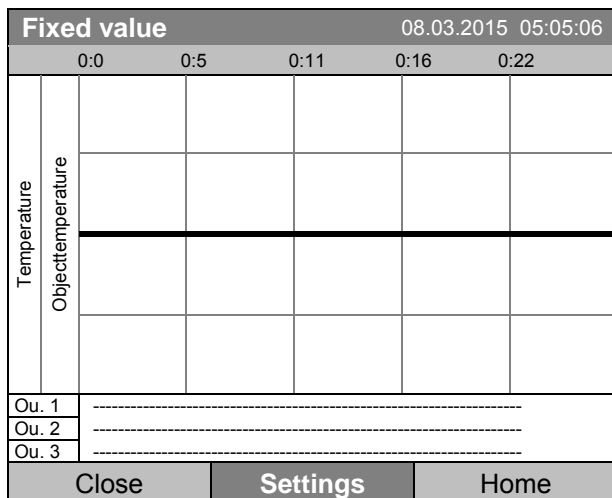

Measurement chart view.
(sample view with optional chamber equipment)

Press the “Settings” button.

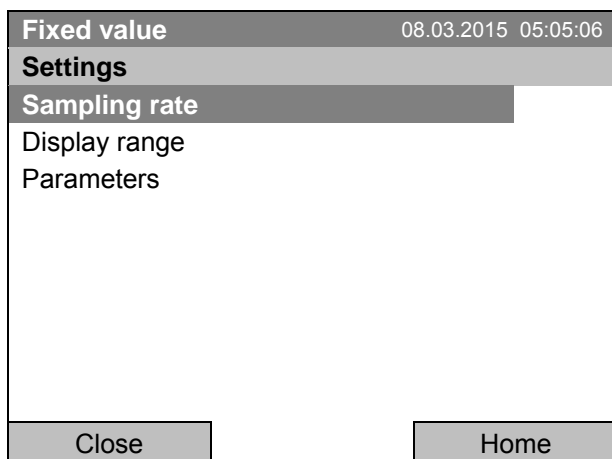

Submenu “Settings”.
Select the desired function
and press the operating button.

16.1 Setting the sampling rate

To define the sampling rate, go to [Menu > Measurement chart > Settings > Sampling rate](#)

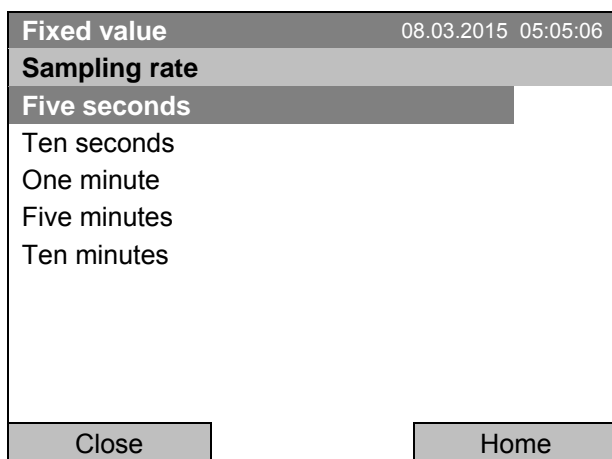

Submenu “Sampling rate”.
Select the desired interval
and press the operating button.

16.2 Defining the display range

To define the sampling rate, go to [Menu > Measurement chart > Settings > Display range](#)

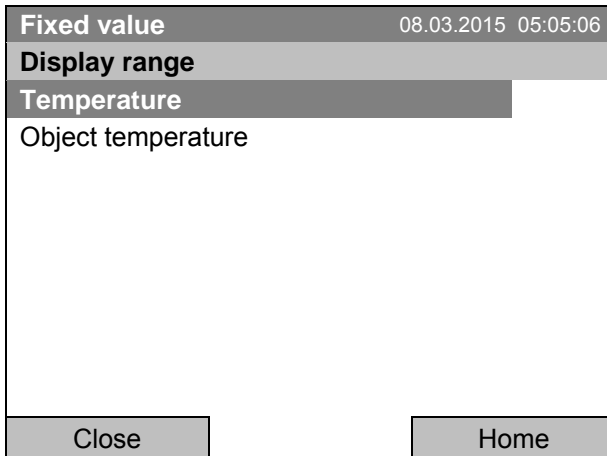

Fixed value 08.03.2015 05:05:06

Display range

Temperature

Object temperature

Close Home

Submenu "Display range"
(The "Object temperature" menu item is visible only with optional chamber equipment)

Select the desired parameter and press the operating button.

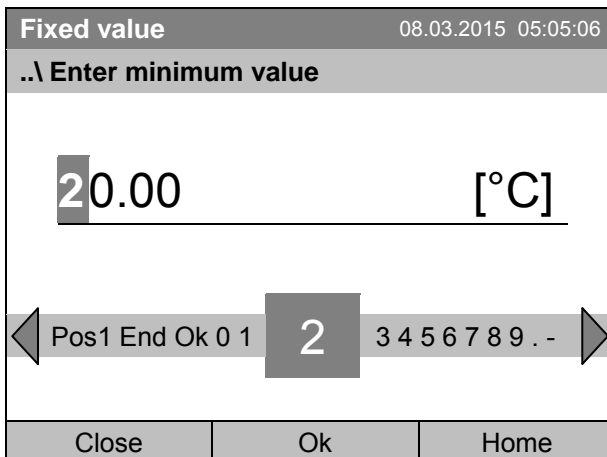

Fixed value 08.03.2015 05:05:06

..\ Enter minimum value

20.00 [°C]

◀ Pos1 End Ok 0 1 2 3 4 5 6 7 8 9 . - ▶

Close Ok Home

Entry menu "Enter minimum value".

Enter the desired value for temperature with the operating button and press the operating button to confirm.

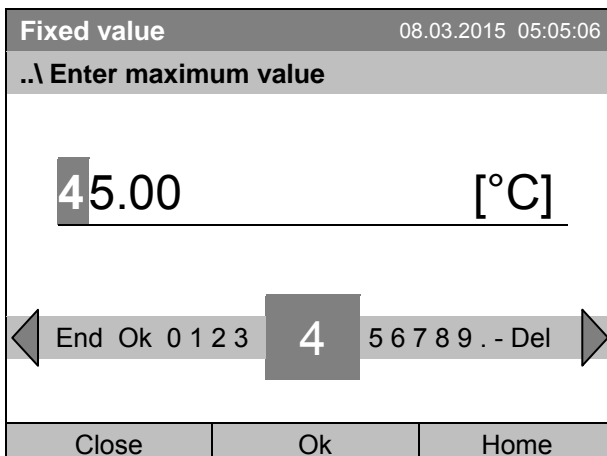

Fixed value 08.03.2015 05:05:06

..\ Enter maximum value

45.00 [°C]

◀ End Ok 0 1 2 3 4 5 6 7 8 9 . - Del ▶

Close Ok Home

Entry menu "Enter maximum value".

Enter the desired value for temperature with the operating button and press the operating button to confirm.

You can now define the view range of other parameters or press the "Close" button twice to go back to the graphic display.

16.3 Selecting the parameters

Here you can select the parameters, which shall be displayed graphically. To select the parameters, go to [Menu > Measurement chart > Settings > Parameters](#)

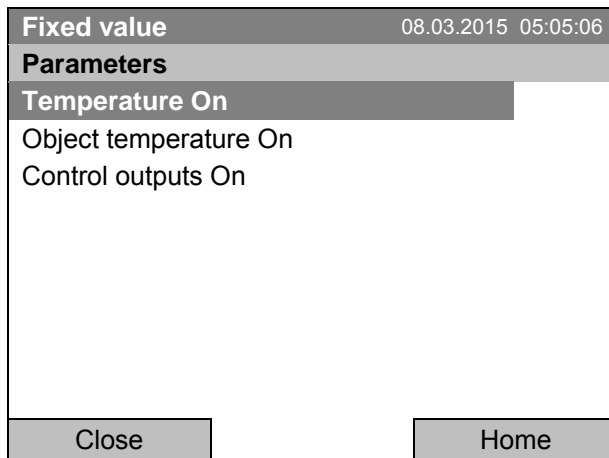

Submenu "Parameters"

(The menu items "Object temperature" and "Control outputs" are visible only with optional chamber equipment)

The current setting for each parameter is displayed.

Select the desired parameter and press the operating button to change its status On/Off.

The modified setting is displayed.

Press the button "Close" twice to go back to the graphic display. If any parameter was set to "Off", it will not be included in the graphical display.

17. Temperature safety devices

17.1 Over temperature protective device (class 1)

The chamber is equipped with an internal temperature safety device class 1 acc. to DIN 12880:2007. It serves to protect the chamber and prevents dangerous conditions caused by major defects.

If a temperature of about 110 °C / 230°F is reached, the over temperature protective device permanently turns off the chamber. The user cannot restart the device again. The protective cut-off device is located internally. Only a service specialist can replace it. Therefore, please contact an authorized service provider or BINDER Service.

17.2 Overtemperature safety controller (temperature safety device class 3.1)

The chamber is regularly equipped with an electronic overtemperature safety controller (temperature safety device class 3.1 according to DIN 12880:2007).

The overtemperature safety controller serves to protect the chamber, its environment and the contents from exceeding the maximum permissible temperature. In the case of an error, it limits the temperature inside the chamber to the entered safety controller set-point.

Please observe the DGUV guidelines 213-850 on safe working in laboratories (formerly BGI/GUV-I 850-0, BGR/GUV-R 120 or ZH 1/119, issued by the employers' liability insurance association) (for Germany).

Set the safety controller set point by approx. 2 °C up to 5 °C above the desired temperature set point. Recommended setting: Set-point type "Offset" with safety controller set-point 2 °C (factory setting).

The safety controller is functionally and electrically independent of the temperature control system. If an error occurs, it performs a regulatory function.



Check the setting regularly and adjust it following changes of the set-point or charge.

17.2.1 Safety controller modes

You can select between "Limit (absolute)" and "Offset (relative)" safety controller mode

- **Limit:** Absolute maximum permitted temperature value

This setting offers high safety as a defined temperature limit will not be exceeded. It is important to adapt the safety controller set-point after each modification of the temperature set-point. Otherwise, the limit could be too high to ensure efficient protection, or, in the opposite case, it could prevent the controller from reaching an entered set-point outside the limit range.

- **Offset:** Maximum overtemperature above any active temperature set point. The maximum temperature changes internally and automatically with every set-point change.

This setting is recommended for program operation. It is important to check the safety controller set-point and safety controller mode occasionally, as it does not offer a fix, independent limit temperature value, which would never be exceeded.

Example: Desired temperature value: 40 °C, desired safety controller value: 45 °C.

Possible settings:

Temperature set point	Safety controller mode	Safety controller set-point
40 °C	Limit (absolute)	45 °C
	Offset (relative)	5 °C

17.2.2 Setting the safety controller

To display and to change the current safety controller settings in the “safety controller” submenu, go to [Menu > Safety controller](#)

Safety controller mode: selection between Limit (absolute) and Offset (relative)

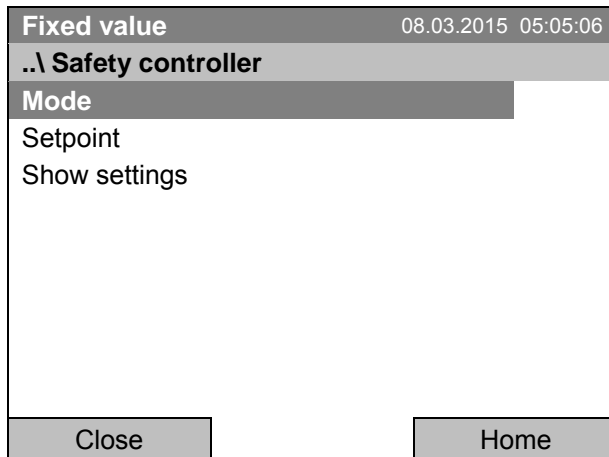

Submenu “Safety controller”
(view with standard chamber equipment)
Select “Mode”
and press the operating button.

or

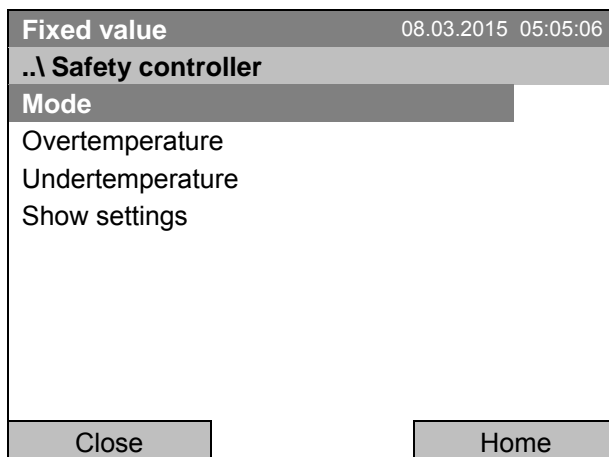

Submenu “Safety controller”
(view with optional chamber equipment)
Select “Mode”
and press the operating button.

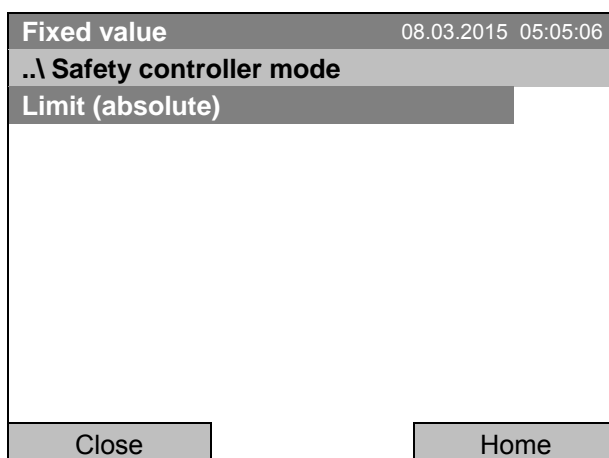

Submenu “Safety controller mode”.
The current safety controller mode is displayed:
“Limit (absolute)” or “Offset (relative)”
To change the mode, press the operating button.
The modified safety controller mode is displayed.



When changing the safety controller mode, the safety controller setpoint which had been active before in this mode becomes active again.

Entering the safety controller setpoint

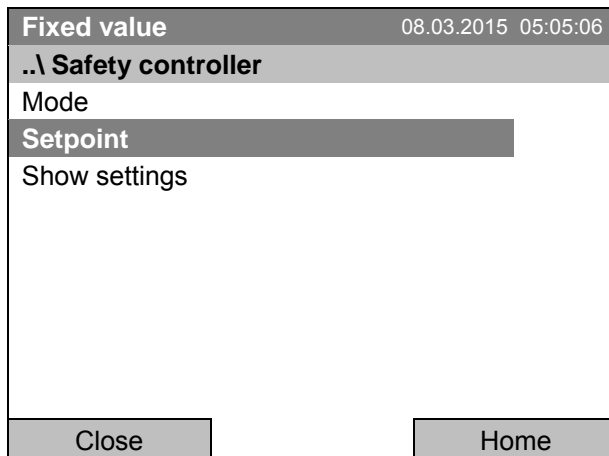

Submenu "Safety controller"
 (view with standard chamber equipment)
 Select "Setpoint"
 and press the operating button.

or

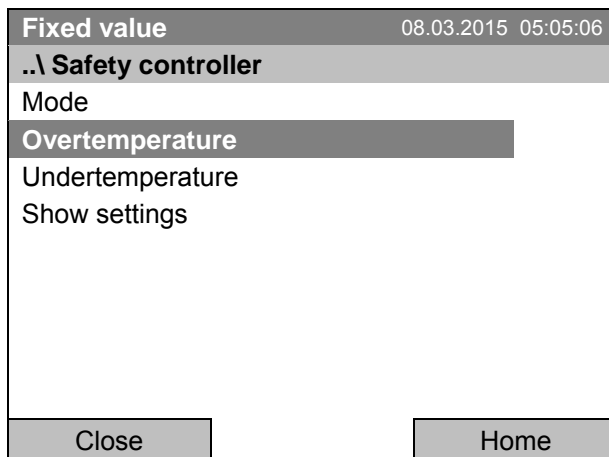

Submenu "Safety controller"
 (view with optional chamber equipment)
 Select "Overtemperature"
 and press the operating button.



In case of a temperature safety device class 3.1 combined with optional chamber equipment, the safety controller setpoint is indicated as "Overtemperature". In this case an additional parameter "Undertemperature" is shown. This latter has no function; if you select it, the message "Setpoints not available" appears.

You can also access this submenu to directly enter the safety controller setpoint via [Quick menu > safety controller setpoint](#)

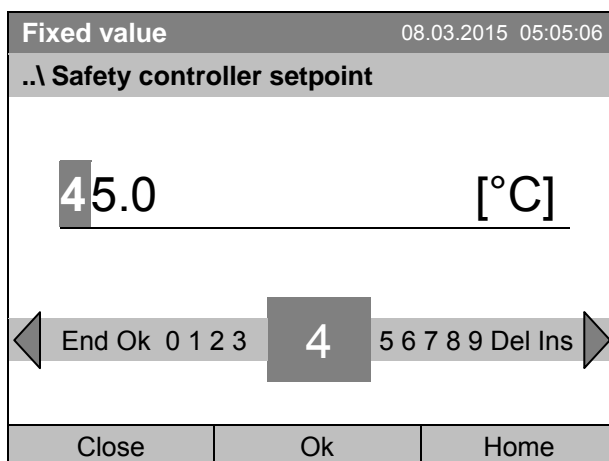

Entry menu "Safety controller setpoint".
 Enter the desired value with the operating button
 and press the operating button to confirm.
 Press the "Ok" button to confirm.

Go one level back with the "Close" button or back to the initial view with "Home".

Overview of the current settings

You can check the current settings of the safety controller:

Fixed value		08.03.2015 05:05:06	
..\ Safety controller			
Mode			
Setpoints			
Show settings			
Close		Home	

Submenu "Safety controller"
(view with standard chamber equipment)
Select "Show settings"
and press the operating button.

The overview display shows the set-points and actual values of the main temperature controller and the safety controller and indicates the safety controller mode.

Fixed value		08.03.2015 05:05:06	
		Setpoint	Actual
Chamber temperature	[°C]	37.0	37.6
Safety controller mode		Limit (absolute)	
Safety controller	[°C]	40.0	37.6
Close		Home	

Overview display with safety controller mode "Limit"
(example values).
In case of a temperature safety device class 3.1
combined with optional chamber equipment, "Safety
controller" is indicated as "Overtemperature" in-
stead.

Fixed value		08.03.2015 05:05:06	
		Setpoint	Actual
Chamber temperature	[°C]	37.0	37.6
Safety controller mode		Offset (relative)	
Safety controller	[°C]	3.0	37.6
Close		Home	

Overview display with safety controller mode "Off-
set" (example values).
In case of a temperature safety device class 3.1
combined with optional chamber equipment, "Safety
controller" is indicated as "Overtemperature" in-
stead.

Go back to the initial view with "Home".

17.3 Over- and undertemperature safety controller (temperature safety device class 3.3) (option)

With this option the chamber is equipped with an electronic over- and undertemperature safety controller. The combination of overtemperature (class 3.1) and undertemperature (class 3.2) protection is regarded as a safety device class 3.3 acc. to DIN 12880:2007.

This over- and undertemperature safety controller serves to protect the chamber, its environment and the contents from exceeding the maximum or minimum permissible temperature. Please observe the DGUV guidelines 213-850 on safe working in laboratories (formerly BGI/GUV-I 850-0, BGR/GUV-R 120 or ZH 1/119, issued by the employers' liability insurance association) (for Germany). The safety controller is functionally and electrically independent of the temperature control system. If an error occurs, it performs a regulatory function.

The **overtemperature safety controller set-point** is a maximum temperature value, which the chamber will not exceed due to the regulatory function of the safety device. This protection against excessively high temperatures serves to protect the chamber, its environment and the contents. In the case of an error, the safety controller limits the temperature inside the chamber to the entered safety controller set-point.

The **undertemperature safety controller set-point** is a minimum temperature value, which the chamber will not fall below due to the regulatory function of the safety device. This protection against excessively low temperatures serves to protect sensitive loads against under cooling. In the case of an error, the safety controller limits the temperature inside the chamber to the entered safety controller set-point.

	Check the setting regularly and adjust it following changes of the set-point or charge.
---	---

17.3.1 Safety controller modes

You can select between "Limit (absolute)" and "Offset (relative)" safety controller mode

- Limit:** Absolute maximum or minimum permitted temperature value
 This setting offers high safety as a defined temperature limit will not be exceeded or fallen below. It is important to adapt the safety controller set-point after each modification of the temperature set-point. Otherwise, the limit could be too big to ensure efficient protection, or, in the opposite case, it could prevent the controller from reaching an entered set-point outside the limit range.
- Offset:** Maximum permitted over- or under temperature above/ below the active temperature set point. The maximum temperature changes internally and automatically with every set-point change.
 This setting is recommended for program operation. It is important to check the safety controller set-point and safety controller mode occasionally, as it does not offer a fix limit value, which would not be exceeded or fallen below.

Example: Desired temperature value: 40 °C, desired overtemperature safety controller value: 45 °C, desired undertemperature safety controller value: 30 °C.

Possible settings:

Temperature set point	Safety controller mode	Overtemperature safety controller set-point	Undertemperature safety controller set-point
40 °C	Limit (absolute)	45 °C	30 °C
	Offset (relative)	5 °C	10 °C

17.3.2 Setting the Over- and undertemperature safety controller

To display and to change the current safety controller settings in the “safety controller” submenu, go to [Menu > Safety controller](#)

Selection between Limit (absolute) and Offset (relative) safety controller mode

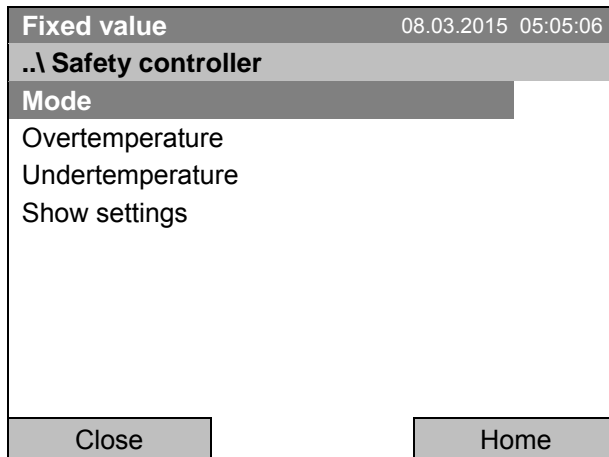

Submenu “Safety controller”.

Select “Mode” and press the operating button.

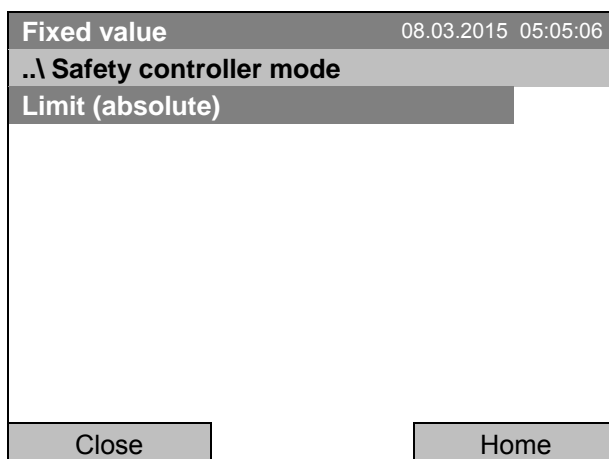

Submenu “Safety controller mode”.

The current safety controller mode is displayed: “Limit (absolute)” or “Offset (relative)”

To change the mode, press the operating button.

The modified safety controller mode is displayed.



When changing the safety controller mode, the safety controller setpoint which had been active before in this mode becomes active again.

Entering the safety controller setpoint for overtemperature

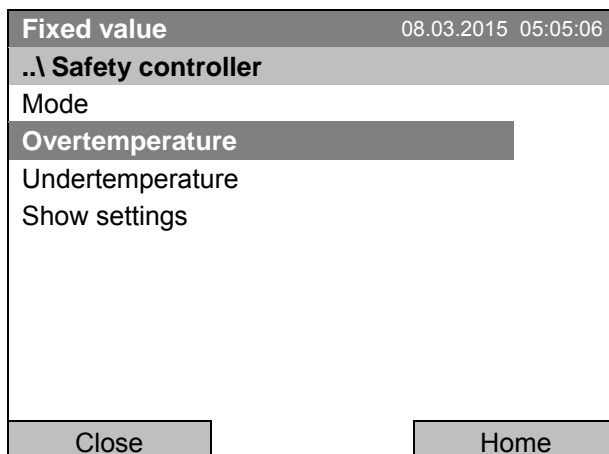

Submenu “Safety controller”

Select “Overtemperature” and press the operating button.

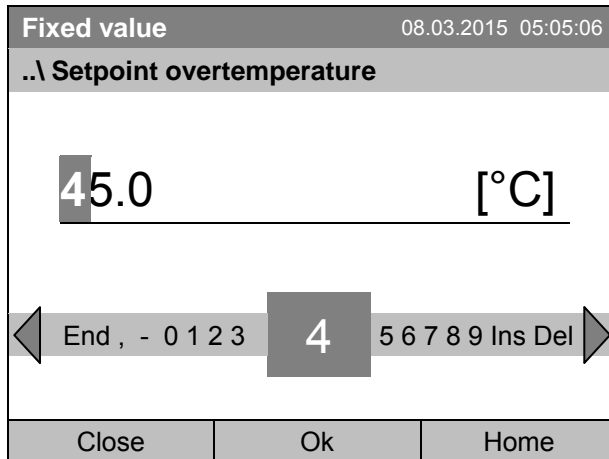

Entry menu "Setpoint overtemperature".
Enter the desired value with the operating button.
Press the "Ok" button to confirm.

You can also access this submenu to directly enter the overtemperature safety controller setpoint via [Quick menu > Safety controller setpoint](#)

Entering the safety controller setpoint for undertemperature

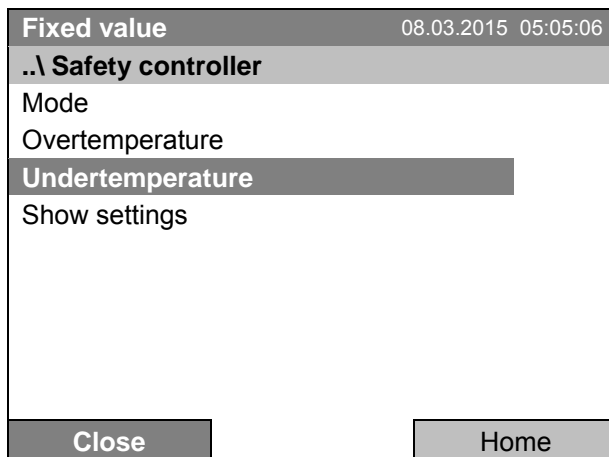

Submenu "Safety controller"
Select "Undertemperature" with the operating button
and press the operating button to confirm.

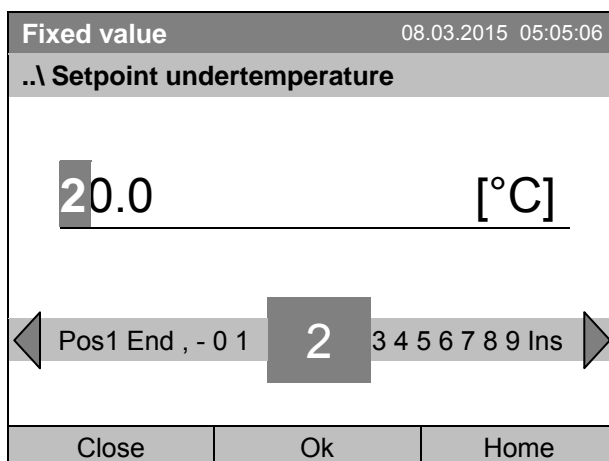

Entry menu "Setpoint undertemperature".
Enter the desired value with the operating button.
Press the "Ok" button to confirm.

Go one level back with the "Close" button or back to the initial view with "Home".

Overview of the current settings

You can check the current settings of the safety controller:

Fixed value		08.03.2015 05:05:06	
..\ Safety controller			
Mode			
Over temperature			
Under temperature			
Show settings			
Close		Home	

Submenu "Safety controller"

Select "Show safety controller settings" and press the operating button.

The overview display shows the set-points and actual values of the main temperature controller and the safety controller and indicates the safety controller mode.

Fixed value		08.03.2015 05:05:06	
		Setpoint	Actual
Chamber temperature	[°C]	37.0	37.6
Safety controller mode		Limit (absolute)	
Overtemperature	[°C]	40.0	37.6
Undertemperature	[°C]	32.0	
Close		Home	

Overview display with safety controller mode "Limit" (example values)

Fixed value		08.03.2015 05:05:06	
		Setpoint	Actual
Chamber temperature	[°C]	37.0	37.6
Safety controller mode		Offset (relative)	
Overtemperature	[°C]	3.0	37.6
Undertemperature	[°C]	5.0	
Close		Home	

Overview display with safety controller mode "Off-set" (example values)

Go back to the initial view with "Home".

18. Defrosting during refrigerating operation

BINDER cooling incubators are very diffusion-proof. To ensure high temperature precision there is no automatic cyclic defrosting device. The DCT™ refrigerating system largely avoids icing of the evaporation plates. However, at very low temperatures the moisture in the air can condense on the evaporator plates leading to icing.

	Always close the door properly.
---	---------------------------------

- **Operation with temperature set-points above +5 °C / 41 °F at an ambient temperature of 25 °C / 77 °F:**

The air defrosts the ice cover automatically. Defrosting is continually performed.

- **Operation with temperature set-points below +5 °C / 41 °F:**

Icing on the evaporator is possible. Defrost the chamber manually.

	<p>With temperature set-points < +5 °C / 41 °F, regularly defrost the chamber manually:</p> <ul style="list-style-type: none"> • Set the temperature to 40 °C / 104 °F (in Fixed value entry mode) • Let the chamber operate for about 30 minutes with the door closed.
---	--

	Excessive frosting of the evaporator is indicated by reduced refrigerating performance.
--	---

- **Operation with temperature set-points below 0 °C / 32 °F**

While operating the chamber with set-points below < 0 °C / 32 °F condensation is possible at the inner surface of the door around the door gasket.

	In case of heavy condensation, check tightness of the door gasket.
---	--

After one or two days operation at a set-point < 0 °C / 32 °F a thin ice layer can cover the inner chamber door and the glass door. The amount depends of the ambient temperature and humidity. This does not influence the proper function of the refrigerating system.

	Refrigerating performance decreases while operating the chamber at temperatures < 0 °C / 32 °F due to icing of the evaporators. For this reason defrost the chamber regularly, e.g. once a week.
---	--

19. Options

19.1 Communication software APT-COM™ 3 DataControlSystem (option)

The chamber is regularly equipped with an Ethernet interface (7) that can connect the BINDER communication software APT-COM™ 3 DataControlSystem. The actual temperature, and fan speed values are given in adjustable intervals. Programming can be performed graphically via PC. Up to 30 chambers with RS 422 interface can be cross linked. For further information, refer to the operating manual of the BINDER communication software APT-COM™ 3.

19.2 RS RS 422 interface (option)

With this option, the chamber is equipped with a serial interface RS 422 (4) instead of the Ethernet interface, that can connect the BINDER communication software APT-COM™ 3 DataControlSystem. The actual temperature, and fan speed values are given in adjustable intervals. Programming can be performed graphically via PC. For further information, refer to the operating manual of the BINDER communication software APT-COM™ 3.

The connection to a computer is established using the chamber interface via an interface converter.

Pin allocation of the RS 422 interface (4) on the chamber rear	Pin 2:	RxD (+)
	Pin 3:	TxD (+)
	Pin 4:	RxD (-)
	Pin 5:	TxD (-)
	Pin 7:	Ground

19.3 Data logger kit (option)

The BINDER Data Logger Kit offers an independent long-term measuring system for temperature, available for different temperature ranges.

The BINDER Data Logger is equipped with a keyboard and a large LCD display, alarm functions and a real-time function. Measurement data are recorded in the Data Logger and can be read out after the measurement via the RS232 interface of the Data Logger. It offers a programmable measuring interval and permits storing up to 64000 measuring values. Reading out is done with the Data Logger evaluation software. You can give out a combined alarm and status protocol directly to a serial printer.

Data Logger Kit T 220: Measuring sensor for the temperature values of the chamber: Temperature range $-90\text{ }^{\circ}\text{C} / 194\text{ }^{\circ}\text{F}$ up to $+220\text{ }^{\circ}\text{C} / 428\text{ }^{\circ}\text{F}$.



For detailed information on installation and operation of the BINDER Data Logger, please refer to the mounting instructions Art. No. 7001-0204 and to the original user manual of the manufacturer, supplied with the data logger.

19.4 Object temperature display with flexible Pt 100 temperature sensor (option)



You can turn on and off the object temperature display via the controller menu (chap. 7.4).

The object temperature display enables the determination of the actual temperature of the charging material during the whole process. The object temperature is measured via a flexible Pt100 temperature sensor and can be viewed at the controller display. You can immerse the sensor top protective tube of the flexible Pt 100 into liquid substances.

Fixed value		08.03.2015 05:05:06	
	Setpoint	Actual value	
Temperature [°C]	25.0	25.2	
Fan [%]	100.0		
Obj. Temp [°C]		25.1	
			
User		Quick menu	Menu

Initial view with object temperature display (sample values)

The object temperature data are put out together with the data of the temperature controller and can be documented by the communication software APT-COM™ (option, chap. 19.1) developed by BINDER.

Technical data of the Pt100 sensor:

- Three-wire technique
- Class B (DIN EN 60751)
- Temperature range up to 320 °C / 608 °F
- Stainless steel protective tube with a length of 45 mm / 1.78 in, material no. 1.4501

19.5 Zero-voltage relay alarm output (may be available via BINDER INDIVIDUAL Customized Solutions)

With this option the chamber is equipped with a zero-voltage relay alarm contact which serves to transmit alarms to a central monitoring facility.

The connection is realized as a DIN socket. A suitable DIN plug is enclosed.

With KB / KB-UL (E4) 53, 115 the DIN (6) socket is located on the chamber rear.

With KB / KB-UL (E6) 240, 400, 720, the DIN socket (6) is located in the right lateral control panel.

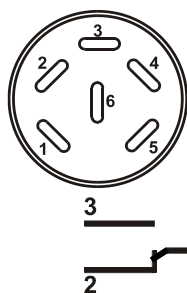



Figure 13: Pin configuration of the DIN socket (6)

Pin 1: Pole, Pin 2: Break relay, Pin 3: Make contact

In case there is no alarm, contact 1 closes with contact 3.

Closing contact 1 with contact 2 switches the zero-voltage relay alarm output.

Maximum loading capacity of the switching contacts: 24V AC/DC – 2.5A

	 DANGER
	<p>Electrical hazard. Danger of death. Damage to switching contacts and connection socket.</p> <ul style="list-style-type: none"> ∅ Do NOT exceed the maximum switching load of 24V AC/DC – 2.5A. ∅ Do NOT connect any devices with a higher loading capacity.

The zero-voltage relay alarm contact is activated in case of temperature tolerance range alarm and in case of a power failure.

Displayed icon	Error when icon is displayed	Switching the alarm contact
	Power failure	immediately
	Temperature tolerance range alarm	10 minutes after the error occurred

A temperature alarm message will remain visible on the controller display during the whole time of the alarm transmission via the zero-voltage relay contact.

As soon as the cause of the alarm is rectified, you can reset the alarm transmission via the zero-voltage relay outputs together with the alarm message at the controller display by pressing the “RESET” key.

In case of a power failure, transmission of the alarm via zero-voltage relay outputs remains active for the duration of the power failure. Afterwards, both contacts will close automatically.

	<p>When using the communication software APT-COM™ 3 DataControlSystem (option, chap. 19.1) via the Ethernet interface or the optional RS422 interface of the chamber for data acquisition, the alarm message is not recorded in the APT-COM™ protocol.</p> <ul style="list-style-type: none"> ➤ Set the tolerance limits for limit alarms by APT-COM™ 3 separately in the APT-COM™ 3 measuring window.
---	---

You can switch on and off the alarm output for test purpose. To access this function, select [Menu > Optional equipment > Alarm output temperature](#) (chap. 7.3).

19.6 Analog output for temperature (option)

With this option the chamber is equipped with an analog output 4-20 mA for temperature. This output allows transmitting data to external data registration systems or devices.

The connection is realized as a DIN socket. A suitable DIN plug is enclosed.

With KB / KB-UL 53 / 115 (E4) the DIN (3) socket is located on the chamber rear.

With KB / KB-UL 240 / 400 / 720 (E6) the DIN socket (3) is located in the right lateral control panel.

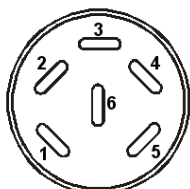

ANALOG OUTPUT 4-20 mA DC

PIN 1: Temperature –

PIN 2: Temperature +

Temperature range: -10 °C / 14 °F to +100 °C / 212 °F

Figure 14: Pin configuration of the DIN socket (3)

19.7 Zero-voltage relay control outputs (may be available via BINDER INDIVIDUAL Customized Solution)

The zero-voltage relay control outputs 1, 2 und 3 are used to switch any device connected via a DIN socket on the chamber rear. They permit turning on and off individually the connected devices by the controller. They can be programmed in fixed value entry mode (chap. 7.2) as well as in the time program editor (chap. 9.3.7) or the week program editor (chap. 10.3.6) via the operation lines.

The connection is realized as a DIN socket. A suitable DIN plug is enclosed.

With KB / KB-UL 53 / 115 (E4) the DIN (5) socket is located on the chamber rear.

With KB / KB-UL 240 / 400 / 720 (E6) the DIN socket (5) is located in the right lateral control panel.

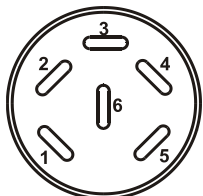

Figure 15: Pin configuration of the DIN socket (5)

Relay output 1	Relay output 2	Relay output 3
 Pin 1: Pin Pin 2: Make	 Pin 3: Pin Pin 4: Make	 Pin 5: Pin Pin 6: Make
Switching state On: 1xx	Switching state On: x1x	Switching state On: xx1

Maximum loading capacity of the switching contacts: 24V AC/DC – 2.5 A

	DANGER
	<p>Electrical hazard. Danger of death. Damage to switching contacts and connection socket.</p> <ul style="list-style-type: none"> ⊘ Do NOT exceed the maximum switching load of 24V AC/DC – 2.5A. ⊘ Do NOT connect any devices with a higher loading capacity.

19.8 Water protected internal socket (option)





You can turn on and off the interior socket via the controller menu (chap. 7.1).

The internal socket is splash proof.

IP system of protection 67 with plug or lid, 100-240 V 1N ~ 50-60 Hz

Charge max. 500 W

Maximum permitted operating temperature with this option: 90 °C / 194 °F.

	 WARNING
	<p>Exceeding the permitted maximum temperature. Electrical hazard. Danger of death. Damage to the internal socket.</p> <ul style="list-style-type: none"> ⊘ Do NOT exceed the temperature set-point of 90 °C / 194 °F. ➤ Set the safety controller to 90 °C / 194 °F. ➤ With optional temperature safety device, class 3.3, set the mechanical thermostat class 3.1 to 90 °C / 194 °F.



Heat emission of electrical devices connected inside the chamber may modify the temperature range.

	CAUTION
	<p>Risk of short circuit. Damage to the chamber.</p> <ul style="list-style-type: none"> ➤ Use the supplied plug only (IP protection type 67). Plug it in and turn it to secure contact. ➤ If the socket is not used, close the screw lid and turn it to secure.

Turning on and off the voltage of the interior socket is possible at the chamber controller through [Menu > Optional equipment > Interior socket](#) >, see chap. 7.1. Turning off the incubator at the main power switch also switches the interior socket voltage-free.

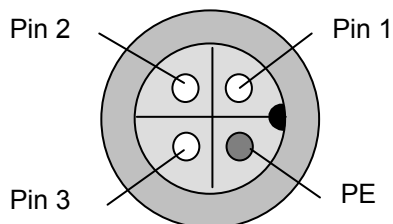

Figure 16: internal socket (front view)

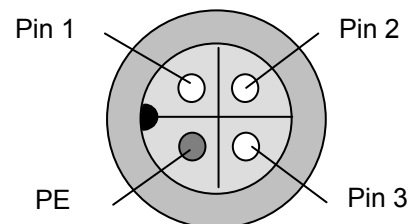





Figure 17: Supplied waterproof plug (front view)

19.9 Interior lighting

Opening the door activates the interior lighting. When closing the door, the interior lighting goes off again.

20. Maintenance, cleaning, and service

20.1 Maintenance intervals, service

 	 DANGER
<p>Electrical hazard. Danger of death.</p> <ul style="list-style-type: none"> ⊘ The chamber must NOT become wet during operation or maintenance works. ⊘ Do NOT remove the rear panel of the chamber. ➤ Before conducting maintenance work, turn off the chamber at the main power switch and disconnect the power plug. ➤ General maintenance work must be conducted by licensed electricians or experts authorized by BINDER. ➤ Maintenance work at the refrigeration system must only be conducted by qualified personnel who underwent training in accordance with EN 13313:2010 (e.g. a refrigeration technician with certified expert knowledge acc. to regulation 303/2008/EC). Follow the national statutory regulations. 	

Ensure regular maintenance work is performed at least once a year and that the legal requirements are met regarding the qualifications of service personnel, scope of testing and documentation. All work on the refrigeration system (repairs, inspections) must be documented.

	<p>The warranty becomes void if maintenance work is conducted by non-authorized personnel.</p>
--	--

	<p>Replace the door gasket only when cold. Otherwise, the door gasket may become damaged.</p>
---	---

With an increased amount of dust in the ambient air, clean the condenser fan (by suction or blowing) several times a year.





We recommend taking out a maintenance agreement. Please consult BINDER Service.

BINDER telephone hotline:	+49 (0) 7462 2005 555
BINDER fax hotline:	+49 (0) 7462 2005 93555
BINDER e-mail hotline:	service@binder-world.com
BINDER service hotline USA:	+1 866 885 9794 or +1 631 224 4340 x3 (toll-free in the USA)
BINDER service hotline Asia Pacific:	+852 390 705 04 or +852 390 705 03
BINDER service hotline Russia and CIS	+7 495 988 15 16
BINDER Internet website	http://www.binder-world.com
BINDER address	BINDER GmbH, post office box 102, D-78502 Tuttlingen

International customers, please contact your local BINDER distributor.

20.2 Cleaning and decontamination

Clean the chamber after each use to avoid potential corrosion damage by ingredients of the test material.

  	 DANGER
	<p>Electrical hazard. Danger of death.</p> <ul style="list-style-type: none"> ∅ Do NOT spill water or cleaning agents over the inner and outer surfaces. ➤ Before cleaning, turn off the chamber at the main power switch and disconnect the power plug. ➤ Completely dry the chamber before turning it on again.

20.2.1 Cleaning

Disconnect the chamber from the power supply before cleaning. Disconnect the power plug.

	<p>The interior of the chamber must be kept clean. Thoroughly remove any residues of charging material</p>
---	--

Wipe the surfaces with a moistened towel. In addition, you can use the following cleaning agents:

Exterior surfaces inner chamber shelves door gaskets	Standard commercial cleaning detergents free from acid or halides. Alcohol based solutions. We recommend using the neutral cleaning agent Art. No. 1002-0016.
Instrument panel	Standard commercial cleaning detergents free from acid or halides. We recommend using the neutral cleaning agent Art. No. 1002-0016.
Zinc coated hinge parts rear chamber wall	Standard commercial cleaning detergents free from acid or halides. Do NOT use a neutral cleaning agent on zinc coated surfaces.

Do not use cleaning agents that may cause a hazard due to reaction with components of the device or the charging material. If there is doubt regarding the suitability of cleaning products, please contact BINDER service.

	<p>We recommend using the neutral cleaning agent Art. No. 1002-0016 for a thorough cleaning. Any corrosive damage that may arise following use of other cleaning agents is excluded from liability by BINDER GmbH. Any corrosive damage caused by a lack of cleaning, is excluded from liability by BINDER GmbH.</p>
---	--

	CAUTION
	<p>Danger of corrosion. Damage to the chamber.</p> <ul style="list-style-type: none"> ∅ Do NOT use acidic or chlorine cleaning detergents. ∅ Do NOT use a neutral cleaning agent on other kind of surfaces e.g., the zinc coated hinge parts or the rear chamber wall.

	<p>For surface protection, perform cleaning as quickly as possible. After cleaning completely remove any cleaning agents from the surfaces with a moistened towel. Let the chamber dry.</p>
---	---





	<p>Soapsuds may contain chlorides and must therefore NOT be used for cleaning.</p>
---	--

	<p>With every cleaning method, always use adequate personal safety controls.</p>
---	--

Following cleaning, leave the chamber door open or remove the access port plugs.

	<p>The neutral cleaning agent may cause health problems in contact with skin and if ingested. Follow the operating instructions and safety hints labeled on the bottle of the neutral cleaning agent.</p>
---	---

Recommended precautions: To protect the eyes use sealed protective goggles. Suitable protective gloves with full contact: butyl or nitrile rubber, penetration time >480 minutes.

	<table border="1"> <tr> <td data-bbox="531 864 1473 943" style="background-color: yellow; text-align: center;">  CAUTION </td> </tr> <tr> <td data-bbox="531 943 1473 1261"> <p>Contact with skin, ingestion. Skin and eye damage due to chemical burns.</p> <ul style="list-style-type: none"> ∅ Do not ingest. Keep away from food and beverages. ∅ Do NOT empty into drains. ➤ Wear protective gloves and goggles. ➤ Avoid skin contact. </td> </tr> </table>	 CAUTION	<p>Contact with skin, ingestion. Skin and eye damage due to chemical burns.</p> <ul style="list-style-type: none"> ∅ Do not ingest. Keep away from food and beverages. ∅ Do NOT empty into drains. ➤ Wear protective gloves and goggles. ➤ Avoid skin contact.
 CAUTION			
<p>Contact with skin, ingestion. Skin and eye damage due to chemical burns.</p> <ul style="list-style-type: none"> ∅ Do not ingest. Keep away from food and beverages. ∅ Do NOT empty into drains. ➤ Wear protective gloves and goggles. ➤ Avoid skin contact. 			

20.2.2 Decontamination

The operator must ensure that proper decontamination is performed in case a contamination of the chamber by hazardous substances has occurred.

Disconnect the chamber from the power supply prior to chemical decontamination. Disconnect the power plug.

Do not use decontamination agents that may cause a hazard due to reaction with components of the device or the charging material. If there is doubt regarding the suitability of cleaning products, please contact BINDER service.

You can use the following disinfectants:

<p>Inner chamber</p>	<p>Standard commercial surface disinfectants free from acid or halides. Alcohol based solutions. We recommend using the disinfectant spray Art. No. 1002-0022.</p>
----------------------	--

	<p>For chemical disinfection, we recommend using the disinfectant spray Art. No. 1002-0022. Any corrosive damage that may arise following use of other disinfectants is excluded from liability by BINDER GmbH.</p>
---	---



With every decontamination method, always use adequate personal safety controls.

In case of contamination of the interior by biologically or chemically hazardous material, there are two possible procedures depending on the type of contamination and charging material.

(1) Spray the inner chamber with an appropriate disinfectant.



Before start-up, the chamber must be absolutely dry and ventilated, as explosive gases may form during the decontamination process.

(2) If necessary, have strongly contaminated inner chamber parts removed by an engineer for cleaning, or have them exchanged. Sterilize the inner chamber parts in a sterilizer or autoclave.



In case of eye contact, the disinfectant spray may cause eye damage due to chemical burns. Follow the operating instructions and safety hints labeled on the bottle of the disinfectant spray.

Recommended precautions: To protect the eyes use sealed protective goggles.

	 CAUTION
	<p>Eye contact. Eye damage due to chemical burns.</p> <p>Ø Do NOT empty into drains. ➤ Wear protective goggles.</p>



After using the disinfectant spray, allow the chamber to dry thoroughly, and aerate it sufficiently.

20.3 Sending the chamber back to BINDER GmbH

If you return a BINDER product to us for repair or any other reason, we will only accept the product upon presentation of an authorization number that has previously been issued to you. An authorization number will be issued after receiving your complaint either in writing or by telephone **prior** to your sending the BINDER product back to us. The authorization number will be issued following receipt of the information below:

- BINDER product type and serial number
- Date of purchase
- Name and address of the dealer from which you bought the BINDER product
- Exact description of the defect or fault
- Complete address, contact person and availability of that person
- Exact location of the BINDER product in your facility
- A contamination clearance certificate (chap. 26) must be faxed in advance

The authorization number must be applied to the packaging in such a way that it can be easily recognized or be recorded clearly in the delivery documents.



For security reasons we cannot accept a chamber delivery if it does not carry an authorization number.

Return address: BINDER GmbH Gänsäcker 16
 Abteilung Service 78502 Tuttlingen
 Germany

21. Disposal

21.1 Disposal of the transport packing

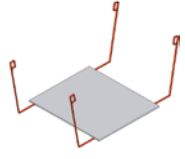
Packing element	Material	Disposal
Straps to fix packing on pallet	Plastic	Plastic recycling
Wooden transport box (option)	Non-wood (compressed matchwood, IPPC standard)	Wood recycling
with metal screws	Metal	Metal recycling
Pallet for KB / KB-UL 53 / 115 (E4)	Solid wood (IPPC standard)	Wood recycling
Pallet for KB / KB-UL 240 / 400 / 720 (E6) with foamed plastic stuffing	Solid wood (IPPC standard)	Wood recycling
	PE foam	Plastic recycling
Shipping box with metal clamps	Cardboard	Paper recycling
	Metal	Metal recycling
Top cover	Cardboard	Paper recycling
Removal aid for KB / KB-UL 115 	Karton	Papier-Recycling
	Kunststoff	Kunststoff-Recycling
Edge protection	Styropor® or PE foam	Plastic recycling
Protection of doors and racks	PE foam	Plastic recycling
Bag for operating manual	PE foil	Plastic recycling
Insulating air cushion foil (packing of optional accessories)	PE foil	Plastic recycling

If recycling is not possible, all packing parts can also be disposed of with normal waste.

21.2 Decommissioning

Turn off the main power switch (1). Disconnect the chamber from the power supply.



When switching off the main power switch ON / OFF (1), the stored parameters remain saved.

- Temporal decommissioning: See indications for appropriate storage, chap. 3.3.
- Final decommissioning: Dispose of the chamber as described in chap. 21.3 to 21.5.

21.3 Disposal of the chamber in the Federal Republic of Germany

According to Annex I of Directive 2012/19/EU of the European Parliament and of the Council on waste electrical and electronic equipment (WEEE), BINDER devices are classified as “monitoring and control instruments” (category 9) only intended for professional use“. They must not be disposed of at public collecting points.

The chambers bear the symbol for the marking of electrical and electronic equipment manufactured / placed on the market in the EC after 13 August 2005 and be disposed of in separate collection according to Directive 2012/19/EU on waste electrical and electronic equipment (WEEE) and German national law for electrical and electronic equipment (Elektro- und Elektronikgerätegesetz, ElektroG). WEEE marking: crossed-out wheeled bin with solid bar under. A significant part of the materials must be recycled in order to protect the environment.

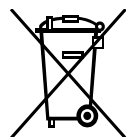



At the end of the device's service life, have the chamber disposed of according to the German national law for electrical and electronic equipment (Elektro- und Elektronikgerätegesetz, ElektroG from 20 October 2015, BGBl. I p. 1739) or contact BINDER service who will organize taking back and disposal of the chamber according to the German national law for electrical and electronic equipment (Elektro- und Elektronikgerätegesetz, ElektroG from 20 October 2015, BGBl. I p. 1739).

	CAUTION
	<p>Violation against existing law.</p> <ul style="list-style-type: none"> ⊘ Do NOT dispose of BINDER devices at public collecting points. ➤ Have the device disposed of professionally at a recycling company which is certified according to the German national law for electrical and electronic equipment (Elektro- und Elektronikgerätegesetz, ElektroG from 20 October 2015, BGBl. I p. 1739). <li style="text-align: center;"><i>or</i> ➤ Instruct BINDER Service to dispose of the device. The general terms of payment and delivery of BINDER GmbH apply, which were valid at the time of purchasing the chamber.

Certified companies disassemble waste (used) BINDER equipment in primary substances for recycling according to Directive 2012/19/EU. The devices must be free from toxic, infectious or radioactive substances in order to eliminate any health hazards to the employees of the recycling companies.

	<p>Prior to handing the chamber over to a recycling company, it is the user's responsibility that it is free from toxic, infectious or radioactive substances.</p> <p>Prior to disposal, clean all introduced or residual toxic substances from the unit.</p> <p>Prior to disposal, disinfect the unit from all sources of infection. Be aware that sources of infection may also be located outside the inner chamber.</p> <p>If you cannot safely remove all toxic substances and sources of infection from the unit, dispose of it as special waste according to national law.</p> <p>Fill out the contamination clearance certificate (chap. 26) and enclose it with the unit.</p>
---	--

	 WARNING
	<p>Contamination of the device with toxic, infectious or radioactive substances.</p> <p>Danger of intoxication.</p> <p>Danger of infection.</p> <ul style="list-style-type: none"> ⊘ NEVER take a chamber contaminated with toxic substances or sources of infection for recycling according to Directive 2012/19/EU. ➤ Prior to disposal, remove all toxic substances and sources of infection from the chamber. ➤ A chamber from which all toxic substances or sources of infection cannot be safely removed must be considered as "special" waste according to national law. Dispose of it accordingly.

The refrigerant used R134A (1,1,1,2-tetrafluoroethane) is not flammable at ambient pressure. It must not be exposed to the environment. In Europe, recovery of the refrigerant R134A (GWP 1300) is mandatory according to regulation No. 842/2006/EC. Ensure the compliance with the applicable legal requirements regarding qualification of staff, disposal, and documentation.

21.4 Disposal of the chamber in the member states of the EU except for the Federal Republic of Germany

According to Annex I of Directive 2012/19/EU of the European Parliament and of the Council on waste electrical and electronic equipment (WEEE), BINDER devices are classified as “monitoring and control instruments” (category 9) only intended for professional use“. They must not be disposed of at public collecting points.

The chambers bear the symbol for the marking of electrical and electronic equipment manufactured / placed on the market in the EC after 13 August 2005 and be disposed of in separate collection according to the Directive 2012/19/EU on waste electrical and electronic equipment (WEEE). WEEE marking: crossed-out wheeled bin with solid bar under.

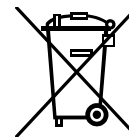

At the end of the device's service life, notify the distributor who sold you the device, who will take back and dispose of the chamber according to the Directive 2012/19/EU on waste electrical and electronic equipment (WEEE).

	<p style="text-align: center;">CAUTION</p> <p>Violation against existing law.</p> <ul style="list-style-type: none"> ⊘ Do NOT dispose of BINDER devices at public collecting points. ➤ Have the device disposed of professionally at a recycling company that is certified according to conversion of the Directive 2012/19/EU into national law. <li style="padding-left: 20px;"><i>or</i> ➤ Instruct the distributor who sold you the device to dispose of it. The agreements apply that were agreed with the distributor when purchasing the chamber (e.g. his general terms of payment and delivery). ➤ If your distributor is not able to take back and dispose of the chamber, please contact BINDER service.
---	--



Certified companies disassemble waste (used) BINDER equipment in primary substances for recycling according to Directive 2012/19/EU. The devices must be free from toxic, infectious or radioactive substances in order to eliminate any health hazards to the employees of the recycling companies.

	<p>Prior to handing the chamber over to a recycling company, it is the user's responsibility that it is free from toxic, infectious or radioactive substances.</p> <p>Prior to disposal, clean all introduced or residual toxic substances from the chamber.</p> <p>Prior to disposal, disinfect the chamber from all sources of infection. Be aware that sources of infection may also be located outside the inner chamber.</p> <p>If you cannot safely remove all sources of infection and toxic substances from the chamber, dispose of it as special waste according to national law.</p> <p>Fill out the contamination clearance certificate (chap. 26) and enclose it with the chamber.</p>
---	--

	WARNING
	<p>Contamination of the device with toxic, infectious or radioactive substances. Danger of intoxication. Danger of infection.</p> <ul style="list-style-type: none"> ⊘ NEVER take a chamber contaminated with toxic substances or sources of infection for recycling according to Directive 2012/19/EU. ➤ Prior to disposal, remove all toxic substances and sources of infection from the chamber. ➤ A chamber from which all toxic substances or sources of infection cannot be safely removed must be considered as "special" waste according to national law. Dispose of it accordingly.

The refrigerant used R134A (1,1,1,2-tetrafluoroethane) is not inflammable at ambient pressure. It must not be exposed to the environment. In Europe, recovery of the refrigerant R134A (GWP 1300) is mandatory according to regulation No. 842/2006/EC. Ensure the compliance with the applicable legal requirements regarding qualification of staff, disposal, and documentation.





21.5 Disposal of the chamber in non-member states of the EU





 	CAUTION
	<p>Alteration of the environment.</p> <ul style="list-style-type: none"> ➤ For final decommissioning and disposal of the chamber, please contact BINDER service. ➤ Follow the statutory regulations for appropriate, environmentally friendly disposal.

The main board of the cooling incubator includes a lithium cell. Please dispose of it according to national regulations.

The refrigerant used R134A (1,1,1,2-tetrafluoroethane) is not inflammable at ambient pressure. It must not be exposed to the environment. In Europe, recovery of the refrigerant R134A (GWP 1300) is mandatory according to regulation No. 842/2006/EC. Ensure the compliance with the applicable legal requirements regarding qualification of staff, disposal, and documentation.

22. Troubleshooting

Fault description	Possible cause	Required measures
General		
Chamber without function.	No power supply.	Check connection to power supply.
	Wrong voltage.	Check power supply for voltage of 100-120V or 200-240V.
	Chamber fuse has responded.	Check chamber fuse and replace it if appropriate. If it responds again, contact BINDER service.
	Controller defective.	Contact BINDER service.
	Nominal temperature exceeded by 10° due to chamber failure. Over temperature protective device (class 1) responds.	
Heating		
Overtemperature. Chamber heating permanently, exceeding the set-point Notification "Heating active". Alarm message "Temp. range"  	Controller defective.	Confirm the alarm (chap. 14.4). Contact BINDER service.
	Semiconductor relay defective.	
	Controller not adjusted.	Confirm the alarm (chap. 14.4). Calibrate and adjust controller.
Excess temperature. Tolerance range alarm: Having reached the set-point, the temperature deviates by more than +/- 2 °C from the set-point for more than 10 minutes. Alarm message "Temp. range" 	Site of installation too warm. Ambient temperature > 25 °C (chap. 3.4).	Confirm the alarm (chap. 14.4). Select cooler installation site.
Excess temperature. Over-temperature safety controller class 3.1 responds. Alarm message: "Safety controller over-temperature" 	Safety controller has turned off the heating. Limit temperature reached. Safety controller set too low. Safety controller set-point value exceeded.	Confirm the alarm (chap. 14.4). Check setting of temperature set-point and of the safety controller set-point. If appropriate, select suitable value.
	Too much external heat load.	Confirm the alarm (chap. 14.4). Reduce heat load.
	Controller defective.	Confirm the alarm (chap. 14.4). Contact BINDER service.
	Safety controller defective.	
	Semiconductor relay defective.	
Excess temperature. With option safety controller class 3.3: over-temperature safety controller class 3.1 responds. Alarm message: "Safety controller over-temperature" 	Safety controller set-point value exceeded.	Confirm the alarm (chap. 14.4). Check temperature setpoint and setting of the overtemperature safety controller. If appropriate, select suitable limit value.
	Too much external heat load.	Confirm the alarm (chap. 14.4). Reduce heat load.
	Controller defective.	Confirm the alarm (chap. 14.4). Contact BINDER service.
	Safety controller defective.	
	Semiconductor relay defective.	

Fault description	Possible cause	Required measures
Heating (continued)		
Too low temperature. Chamber doesn't heat up. Notification "Heating active". 	Heating defective.	Contact BINDER service.
	Semiconductor relay defective.	
Too low temperature. With option safety controller class 3.3: undertemperature safety controller class 3.2 responds Alarm message: "Safety controller Under-temperature" 	Safety controller set-point value exceeded.	Check setting of temperature set-point and of the safety controller class 3.2 set-point. If appropriate, select suitable value.
	Controller defective.	Confirm the alarm (chap. 14.4). Contact BINDER service.
	Safety controller defective.	
Too low temperature. Tolerance range alarm: Having reached the set-point, the temperature deviates by more than +/- 2 °C from the set-point for more than 10 minutes, or the temperature doesn't reach the tolerance range within 3 hours from turning on the chamber or closing the door. Alarm message "Temp. range" 	Chamber door not properly closed.	Confirm the alarm (chap. 14.4). Completely close chamber door.
	Door gasket defective.	Confirm the alarm (chap. 14.4). Replace door gasket.
	Controller defective.	Confirm the alarm (chap. 14.4). Check the controller function. If appropriate, contact BINDER service
Too low temperature. Set-point temperature is not reached after specified time.	Chamber door not properly closed.	Completely close chamber door.
	Door gasket defective.	Replace door gasket.
	Controller not adjusted.	Calibrate and adjust controller.
Very long heating-up times.	Chamber fully loaded.	Load the chamber less or consider longer heating-up times.
Refrigerating performance		
Temperature set-point temperature is not reached after specified time.	Chamber door not properly closed.	Completely close chamber door.
	Door gasket defective.	Replace door gasket.
	Controller not adjusted.	Calibrate and adjust controller.
Low or no refrigerating performance. Notification: "Refrigeration active" 	Ambient temperature above 25 °C / 77 °F (chap. 3.4).	Select cooler place of installation.
	Compressor not turned on.	Contact BINDER service.
	Solenoid valves defective.	
	No or insufficient refrigerant.	Reduce heat load.
	Too much external heat load.	
Controller		
Program duration longer than programmed.	Inappropriate tolerances have been programmed.	For rapid transition phases, do NOT program tolerance limits in order to allow maximum heating speed.
Message "Sensor rupture"	Sensor rupture between sensor and controller or Pt100 sensor defective	Contact BINDER service.

Fault description	Possible cause	Required measures
Controller (continued)		
No controller operation possible. Notification "Key lock activated". 	Key lock activated.	Enter the key lock password (chap. 11).

	Only qualified service personnel authorized by BINDER must perform repair. Repaired chambers must comply with the BINDER quality standards.
---	--

23. Technical description

23.1 Factory calibration and adjustment

This chamber was calibrated and adjusted in the factory. Calibration and adjustment were performed using standardized test instructions, according to the QM DIN EN ISO 9001 system applied by BINDER (certified since December 1996 by TÜV CERT). All test equipment used is subject to the administration of measurement and test equipment that is also constituent part of the BINDER QM DIN EN ISO 9001 systems. They are controlled and calibrated to a DKD-Standard at regular intervals.

	Repeated calibrations are recommended in periods of 12 months.
--	--

23.2 Over current protection

The chambers are equipped with an internal fuse (over-current release) not accessible from outside. If this fuse is blown, please contact an electronic engineer or BINDER Service.

In addition, the chambers KB 53-UL / 115-UL are protected by a chamber-protection against over current, accessible from the outside. It is located at the rear of the chamber below the strain relief of the power cord. The fuse holder is equipped with a fuse clip 6.3 x32 mm. Replace this fuse only with a substitute of the same ratings. Refer to the technical data of the respective device type. If this fuse is blown, please inform an electronic engineer or BINDER service.

23.3 Definition of usable volume

The usable volume illustrated below is calculated as follows:

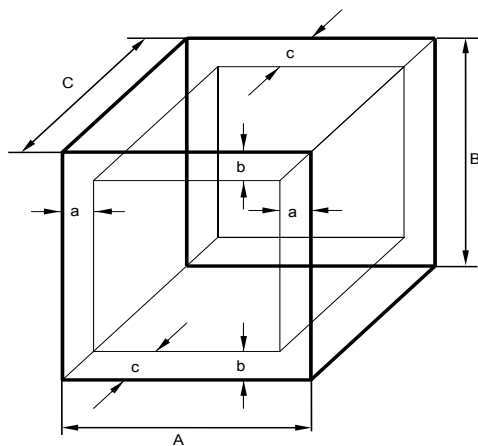

A, B, C = internal dimensions (W, H, D)
a, b, c = wall separation

$a = 0.1 * A$
 $b = 0.1 * B$
 $c = 0.1 * C$

$$V_{USE} = (A - 2 * a) * (B - 2 * b) * (C - 2 * c)$$

Figure 18: Determination of the usable volume

The technical data refers to the defined usable volume.



Do NOT place samples outside this usable volume.

Do NOT load this volume by more than half to enable sufficient airflow inside the chamber.

Do NOT divide the usable volume into separate parts with large area samples.

Do NOT place samples too close to each other in order to permit circulation between them and thus obtain a homogenous temperature distribution.

23.4 Technical data

Chamber size		53	115	240	400	720	
Exterior dimensions							
Width, net	mm / inch	635 / 25.00	835 / 32.88	925 / 36.42	925 / 36.42	1250/49.21	
Height, gross (incl. feet/castors)	mm / inch	840 / 33.10	1025/40.35	1460/57.48	1945/76.57	1925/75.79	
Depth, net	mm / inch	580 / 22.83	650 / 25.60	800 / 31.50	800 / 31.50	890 / 35.04	
Depth, gross (incl. door handle, instrument panel, connection)	mm / inch	660 / 25.98	730 / 28.74	880 / 34.65	880 / 34.65	970 / 38.20	
Wall clearance rear (minimum) spacers	mm / inch	100 / 3.94	100 / 3.94	100 / 3.94	100 / 3.94	100 / 3.94	
Wall clearance side(minimum)	mm / inch	160 / 6.30	160 / 6.30	100 / 3.94	100 / 3.94	100 / 3.94	
Doors							
Number of doors		1	1	1	1	2	
Number of inner glass doors		1	1	1	1	2	
Interior dimensions							
Width	mm / inch	400 / 15.75	600 / 23.62	650 / 25.59	650 / 25.59	970 / 38.19	
Height	mm / inch	400 / 15.75	480 / 18.90	785 / 30.90	1270/50.00	1250/49.21	
Depth	mm / inch	330 / 12.99	400 / 15.75	485 / 19.09	485 / 19.09	576 / 22.68	
Interior volume	l / cu.ft.	53 / 1.9	115 / 4.1	247 / 8.7	400 / 14.1	698 / 24.6	
Steam space volume	l / cu.ft.	36 / 1.27	77 / 2.72	348 / 12.3	564 / 19.3	918 / 32.4	
Racks							
Quantity of racks (regular)		2	2	2	2	2	
Quantity of racks (max.)		4	5	9	15	15	
Maximum load per rack	Kg / lbs	15 / 33	20 / 44	30 / 66	30 / 66	45 / 99	
Maximum permitted total load	Kg / lbs	40 / 88	50 / 110	100 / 220	120 / 265	150 / 331	
Weight							
Weight (empty)	Kg / lbs	78 / 172	106 / 234	171 / 377	221 / 487	304 / 670	
Temperature data							
Temperature range		°C °F	-5 to +100 23 to 212	-5 to +100 23 to 212	-5 to +100 23 to 212	-5 to +100 23 to 212	-5 to +100 23 to 212
Temperature fluctuation	max.	+/- K	0,2	0,2	0,1	0,1	0,1
	at 4 °C / 39.2 °F	+/- K	0,1	0,1	0,1	0,1	0,1
	at 25 °C / 77 °F	+/- K	0,1	0,1	0,1	0,1	0,1
	at 37 °C / 98.6 °F	+/- K	0,1	0,1	0,1	0,1	0,1
Temperature uniformity (variation)	max.	+/- K	0,1 to 1,0	0,1 to 1,2	0,1 to 0,8	0,1 to 1,0	0,1 to 0,5
	at 4 °C / 39.2 °F	+/- K	0,6	0,5	0,4	0,4	0,4
	at 25 °C / 77 °F	+/- K	0,2	0,1	0,2	0,2	0,2
	at 37 °C / 98.6 °F	+/- K	0,2	0,2	0,2	0,2	0,2
Max. heat compensation at 40 °C / 104°F		W	150	210	300	500	500
Recovery time after doors were open for 30 sec.	at 4 °C / 39.2 °F	minutes	3	4	12	14	19
	at 25 °C / 77 °F	minutes	1	1	1	1	1
	at 37 °C / 98.6 °F	minutes	2	2	2	4	3

Chamber size			53	115	240	400	720
Electrical data (model versions KB053-230V, KB115-230V, KB240-230V, KB400-230V, KB720-230V)							
IP system of protection acc. to EN 60529			20	20	20	20	20
Nominal voltage (+/-10%)	at 50 Hz power frequency	V	230	230	200-230	200-230	200-230
	at 60 Hz power frequency	V	---	---	200-230	200-230	200-230
Current type			1N~	1N~	1N~	1N~	1N~
Power plug			shock proof plug				
Nominal power		kW	0.60	0,70	1.20	1.40	2.10
Overvoltage category acc. to IEC 61010-1			II	II	II	II	II
Pollution degree acc. to IEC 61010-1			2	2	2	2	2
Over-current release category B, 2 poles		Amp	16 internal	16 internal	16 internal	16 internal	16 internal
Different electrical data for KB-UL constructed for the USA and Canada (model versions KB053UL-120V, KB115UL-120V, KB240UL-120V, KB400UL-120V, KB720UL-240V)							
Nominal voltage (+/-10%)	at 50 Hz power frequency	V	---	---	100-120	100-120	200-240
	at 60 Hz power frequency	V	115	115	100-120	100-120	200-240
Current type			1N~	1N~	1N~	1N~	2~
Power plug		NEMA	5-15P	5-15P	5-20P	5-20P	6-20P
Chamber fuse 6,3 x 32 mm 250V / super-time-lag TT		Amp	12.5 external	12.5 external	---	---	---
Over-current release category B, 2 poles		Amp	16 internal	16 internal	16 internal	16 internal	16 internal
Environment-specific data (model versions KB053-230V, KB115-230V, KB240-230V, KB400-230V, KB720-230V)							
Noise level (mean value.)		dB (A)	49	49	53	53	53
Energy consumption	at 4 °C / 39.2°F	Wh/h	≤ 260	≤ 250	≤ 350	≤ 380	≤ 420
	at 25 °C / 77°F	Wh/h	≤ 220	≤ 210	≤ 300	≤ 300	≤ 390
	at 37 °C / 98.6°F	Wh/h	≤ 70	≤ 75	≤ 270	≤ 330	≤ 360
Filling weight of refrigerant R 134A (GWP 1300)		Kg / lbs	0.150 / 0.33	0.130 / 0.29	0.240 / 0.53	0.300 / 0.66	0.440 / 0.97
Different environment-specific data for KB-UL constructed for the USA and Canada (model versions KB053UL-120V, KB115UL-120V, KB240UL-120V, KB400UL-120V, KB720UL-240V)							
Filling weight of refrigerant R 134A (GWP 1300)		Kg / lbs	0.140 / 0.31	0.130 / 0.29	0.240 / 0.53	0.300 / 0.66	0.440 / 0.97

All technical data is specified for unloaded chambers with standard equipment at an ambient temperature of +22 °C +/- 3°C / 71.6 °F +/- 5.4 °F and a power supply voltage fluctuation of +/- 10%. Technical data is determined in accordance to BINDER Factory Standard Part 2:2015 and DIN 12880:2007.

All indications are average values, typical for chambers produced in series. We reserve the right to change technical specifications at any time.

	Refrigerating performance decreases while operating the chamber at temperatures below 0 °C / 32 °F due to icing of the evaporators. For this reason defrost the chamber regularly, e.g. once a week.
---	--

	If the chamber is fully loaded, the specified heating up and cooling down times may vary according to the load.
---	---

23.5 Equipment and Options (extract)



To operate the cooling incubator, use only original BINDER accessories or accessories / components from third-party suppliers authorized by BINDER. The user is responsible for any risk arising from using unauthorized accessories.

Chamber size	KB (E4)		KB (E6)		
	53	115	240	400	720
Regular equipment					
Multifunction program controller T4.12 with digital display	●	●	●	●	●
Overtemperature safety controller class 3.1 acc. to DIN 12880:2007	●	●	●	●	●
Ethernet interface	●	●	●	●	●
Programmable key lock	●	●	●	●	●
Inner glass door	●	●	●	●	●
DCT™ refrigerating system with refrigerant R134a	●	●	●	●	●
Four castors (2 lockable)	--	--	●	●	●
Access port 30 mm left, with silicone plug	--	--	●	●	●
Door heating	--	--	●	●	●
Options / accessories					
Additional shelf, stainless steel	○	○	○	○	○
Perforated shelf, stainless steel	--	--	○	○	○
Reinforced rack stainless steel with 1 set of rack lockings (max. load 70 kg / 154.3 lb)	--	○	○	○	○
Reinforced rack (max. load 67 kg / 147.7 lb) with additional fixation for operating shakers, stirrers, roller systems	○	○	○	○	○
Rack lockings (4 pc.)	○	○	○	○	○
Additional access ports 10 mm / 0.39 in / 30 mm / 1.18 in / 50 mm / 1.97 in or 100 mm / 3.94 in mm with silicone plug	○	○	--	--	--
Additional access ports 30 mm / 1.18 in, 50 mm / 1.97 in or 100 mm / 3.94 in, with silicone plug	--	--	○	○	○
Rubber pads for safe stacking (4 pieces)	○	○	--	--	--
RS422 communication interface	○	○	○	○	○
Zero-voltage relay alarm output with DIN socket (6 poles), DIN plug included	○	○	○	○	○
Zero-voltage relay control outputs via operation lines output to DIN socket (6 poles), DIN plug included (may be available by BINDER INDIVIDUAL Customized Solutions)	○	○	○	○	○
Water-proof interior socket 100-240 V AC IP 67 (plug IP 67)	○	○	○	○	○
Object temperature display with flexible Pt 100 temperature sensor	○	○	○	○	○
Analog output for temperature 4-20mA, not adjustable, with DIN socket (6 poles), DIN plug included	○	○	○	○	○
Data Logger Kit T 220	○	○	○	○	○
Lockable door	○	○	○	○	○
Over- and undertemperature safety controller class 3.3 acc. to DIN 12880:2007	○	○	○	○	○
Interior lighting (KB / KB-UL 53 / 115 / 240: 15 W; KB / KB-UL 400 / 720: 30 W)	○	○	○	○	○
Factory calibration certificate	○	○	○	○	○
Spatial temperature measurement with certificate	○	○	○	○	○
Qualification folder	○	○	○	○	○
Stable table on wheels with castors and locking brakes	○	○	--	--	--

23.6 Spare parts and accessories (extract)

	<p>BINDER GmbH is responsible for the safety features of the chamber only, provided skilled electricians or qualified personnel authorized by BINDER perform all maintenance and repair, and if components relating to chamber safety are replaced in the event of failure with original spare parts. The user is responsible for any risks arising from using unauthorized accessories/components.</p>
---	---

Chamber size	KB / KB-UL (E4)		KB / KB-UL (E6)		
	53	115	240	400	720
Description	Art.-No.				
Shelf, stainless steel	6004-0007	6004-0008	6004-0101	6004-0101	6004-0106
Perforated shelf, stainless steel	6004-0029	6004-0030	6004-0040	6004-0040	8009-0486
Perforated rack with add. fixation for shaker operation	8012-0287	8012-0288	8012-0639	8012-0639	8012-0673
Reinforced rack with rack lockings	--	--	8012-0638	8012-0638	8012-0674
Door gasket silicone	6005-0095	6005-0096			
Door gasket silicone (kettle)	--	--	6005-0147	6005-0212	6005-0196
Door gasket silicone (outer door)	--	--	6005-0161	6005-0211	6005-0197
Intermediate door gasket silicone	--	--	--	--	6005-0192

Description	Art.-No.
Rubber pads for safe stacking (4 pieces) KB / KB-UL 53 / 115 (E4)	8012-0001
Chamber fuse 6,3 x 32 mm / 250 V / 12.5 Amp super-time-lag (TT) KB 53-UL / 115-UL (E4)	
Securing elements for additional fastening of racks (4 pieces) KB / KB-UL 53 / 115 (E4)	8012-0531
Securing elements for additional fastening of racks (4 pieces) KB / KB-UL 240 / 400 / 720 (E6)	8012-0620
Flexible tilt protection kit	8009-0828
Plug for silicon access port d30	6016-0035
Data Logger Kit T 220	8012-0715
Cleaning kit (neutral cleaning agent, disinfection spray and lint-free disposable wipes, protective gloves and goggles)	8012-0503
Neutral cleaning agent, 1 kg	1002-0016
Stable table on wheels with castors and locking brakes KB / KB-UL 53 / 115 (E4)	9051-0018

For information on components not listed here, please contact BINDER Service.

Validation service	Art.-No.
Qualification folder IQ-OQ	8012-0873
Qualification folder IQ-OQ-PQ	8012-0960
Execution of IQ-OQ	DL410200
Execution of IQ-OQ-PQ	DL440500

Calibration service	Art.-No.
Calibration of temperature including certificate (1 measuring point)	DL300101
Spatial temperature measurement including certificate (9 measuring points)	DL300109
Spatial temperature measurement including certificate (18 measuring points)	DL300118
Spatial temperature measurement including certificate (27 measuring points)	DL300127

23.7 KB / KB-UL 53 dimensions

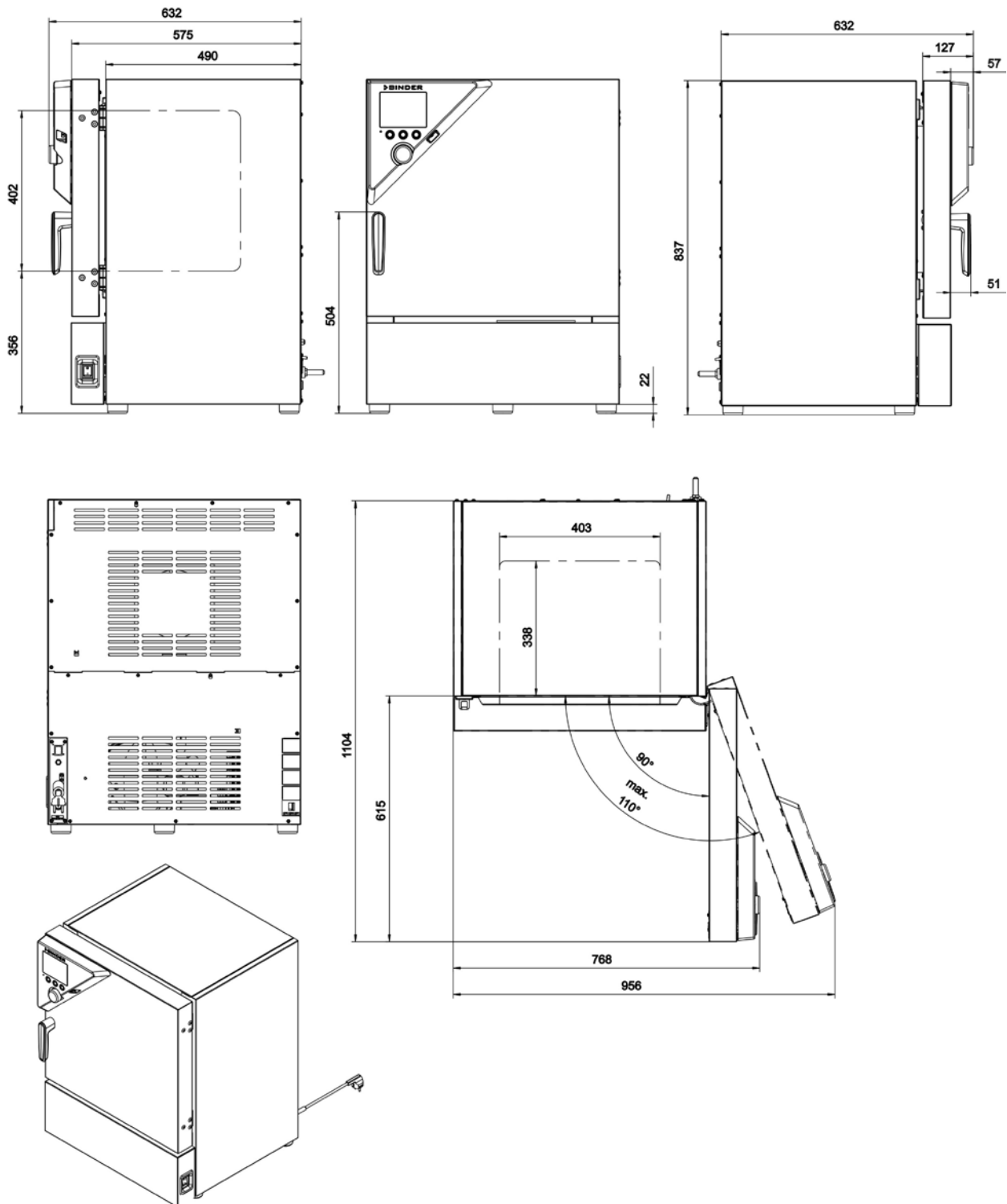

[mm]

23.8 KB / KB-UL 115 dimensions

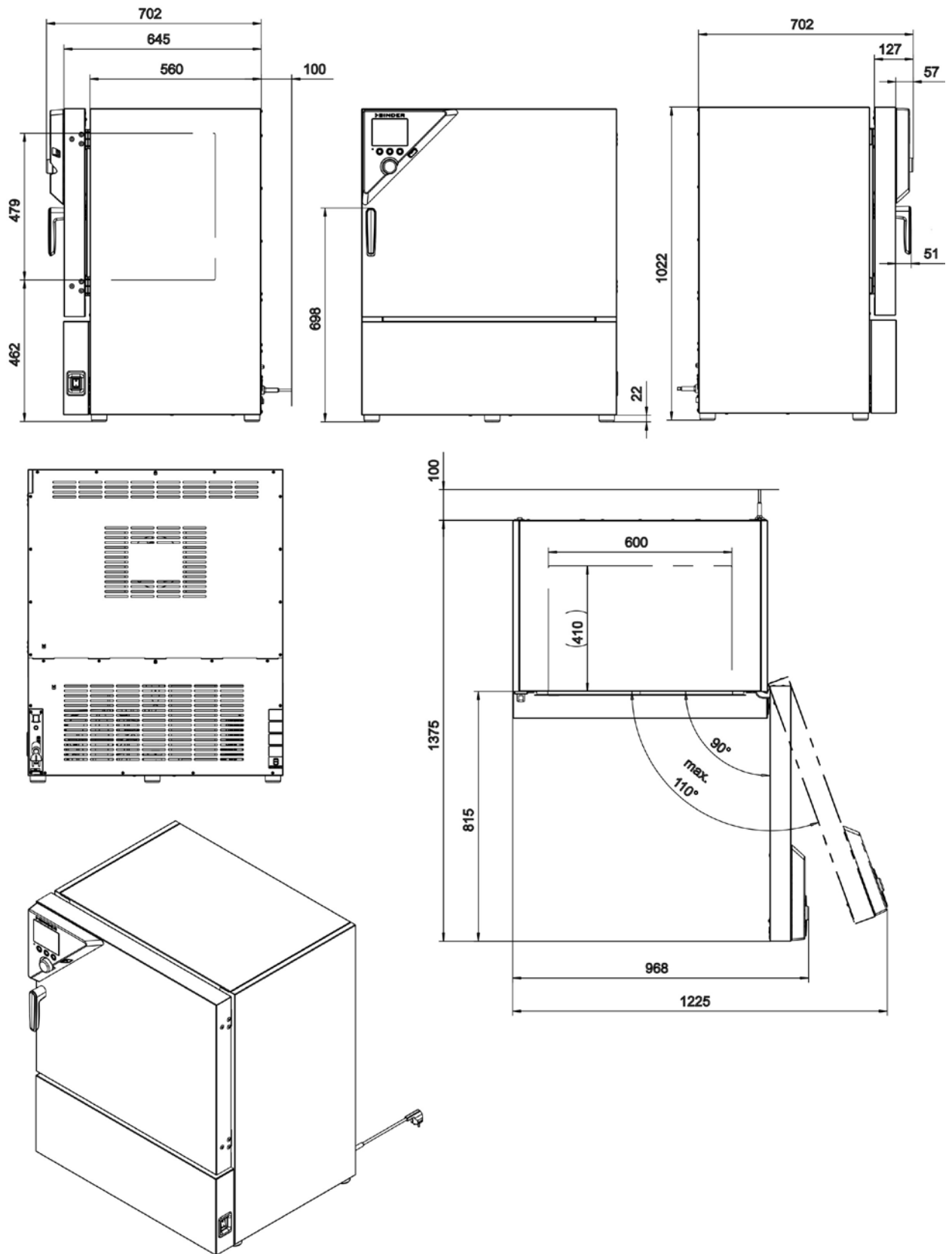

23.9 KB / KB-UL 240 dimensions

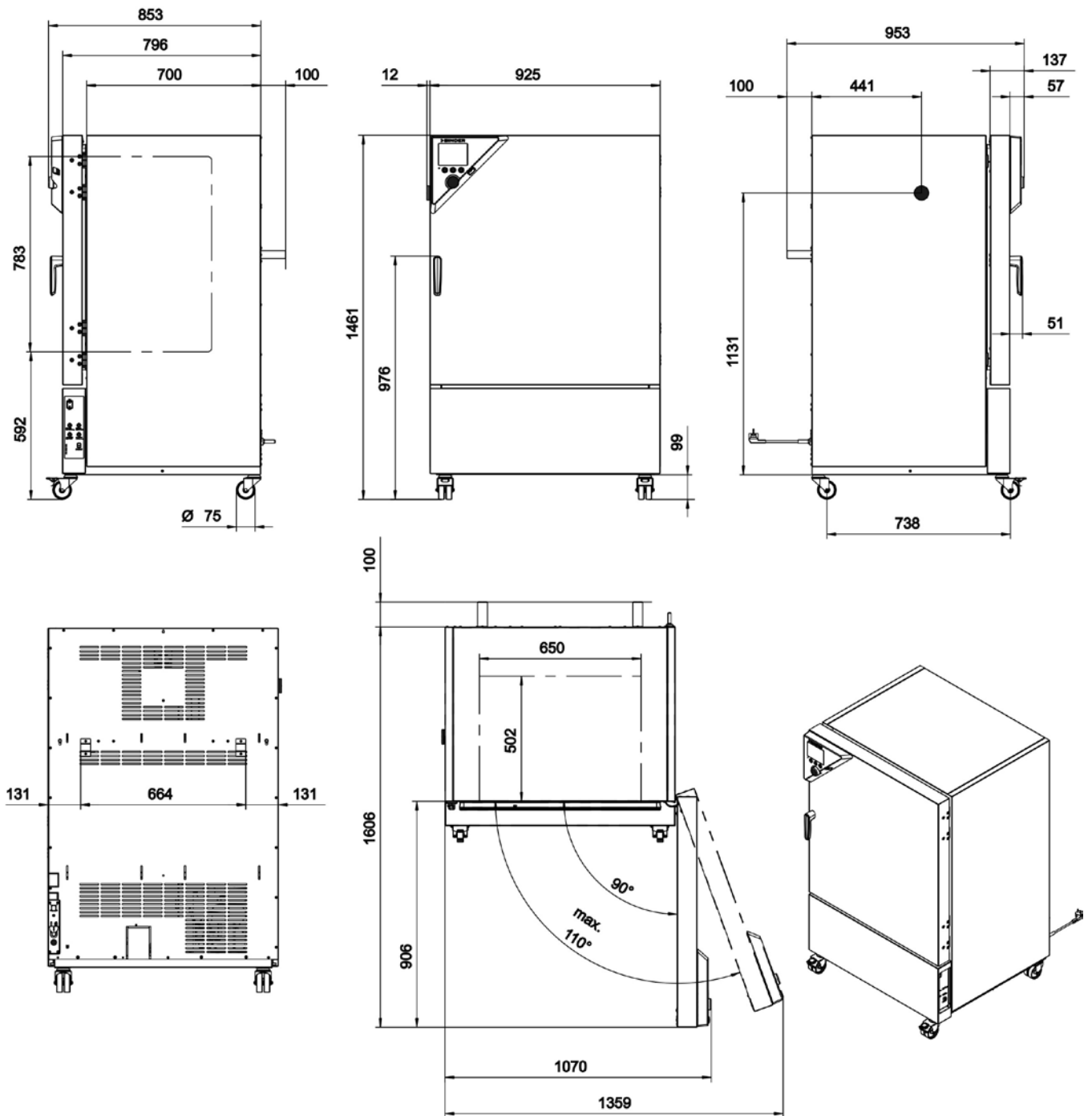

[mm]

23.10 KB / KB-UL 400 dimensions

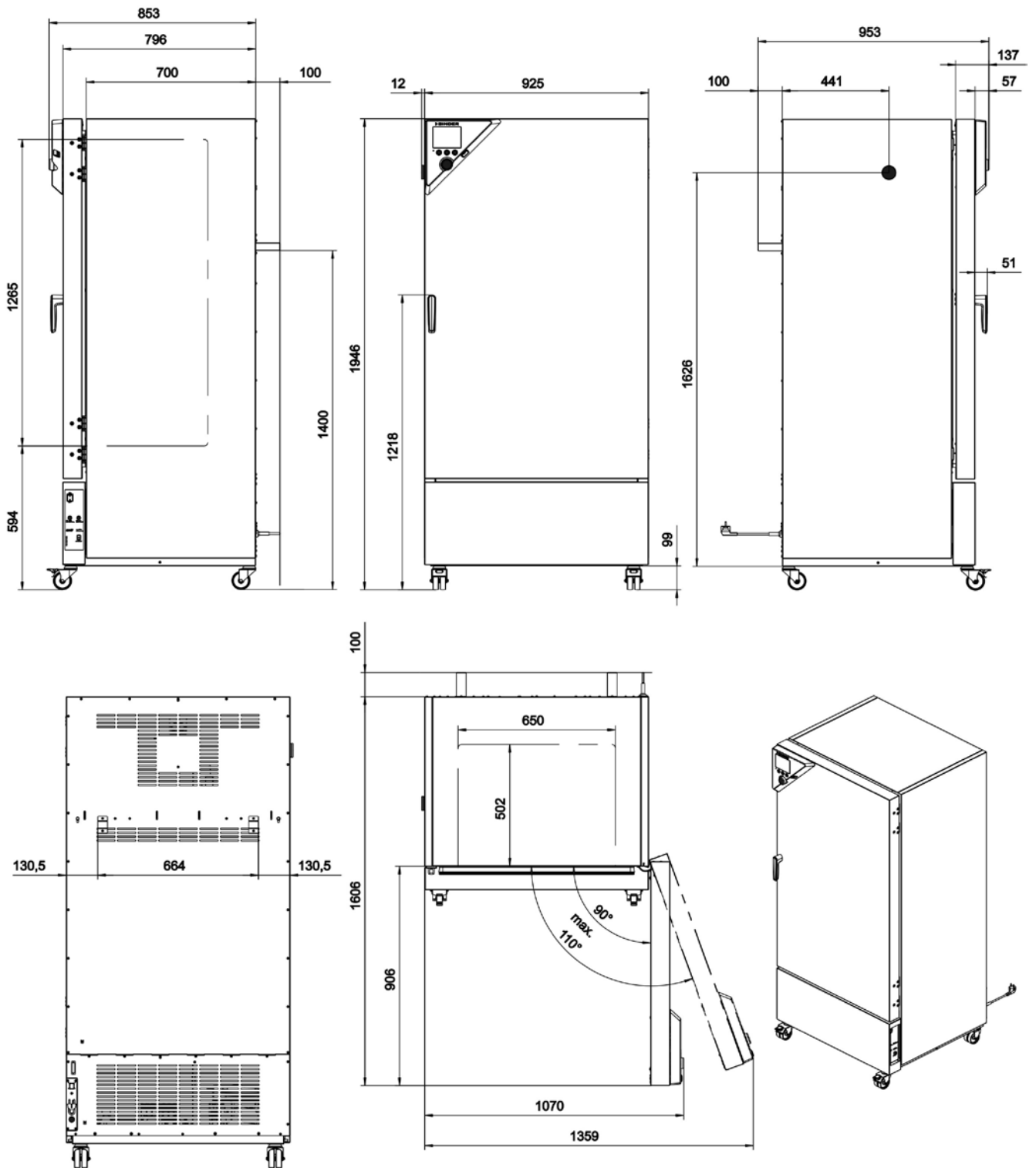

[mm]

23.11 KB / KB-UL 720 dimensions

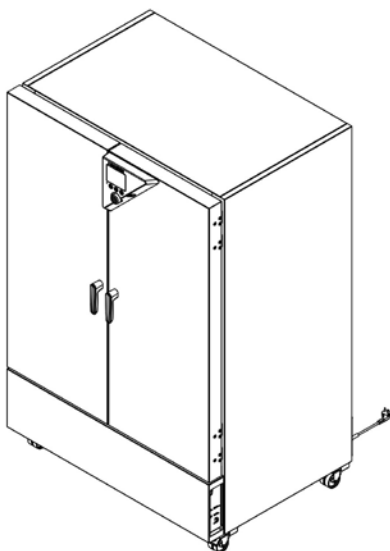
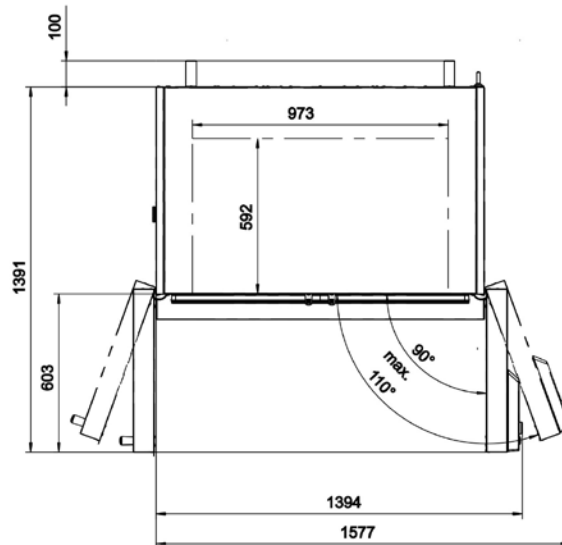
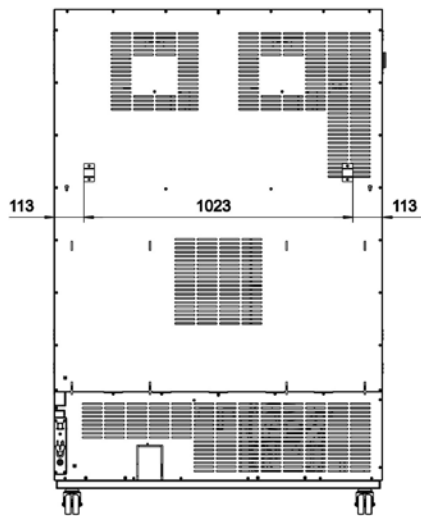
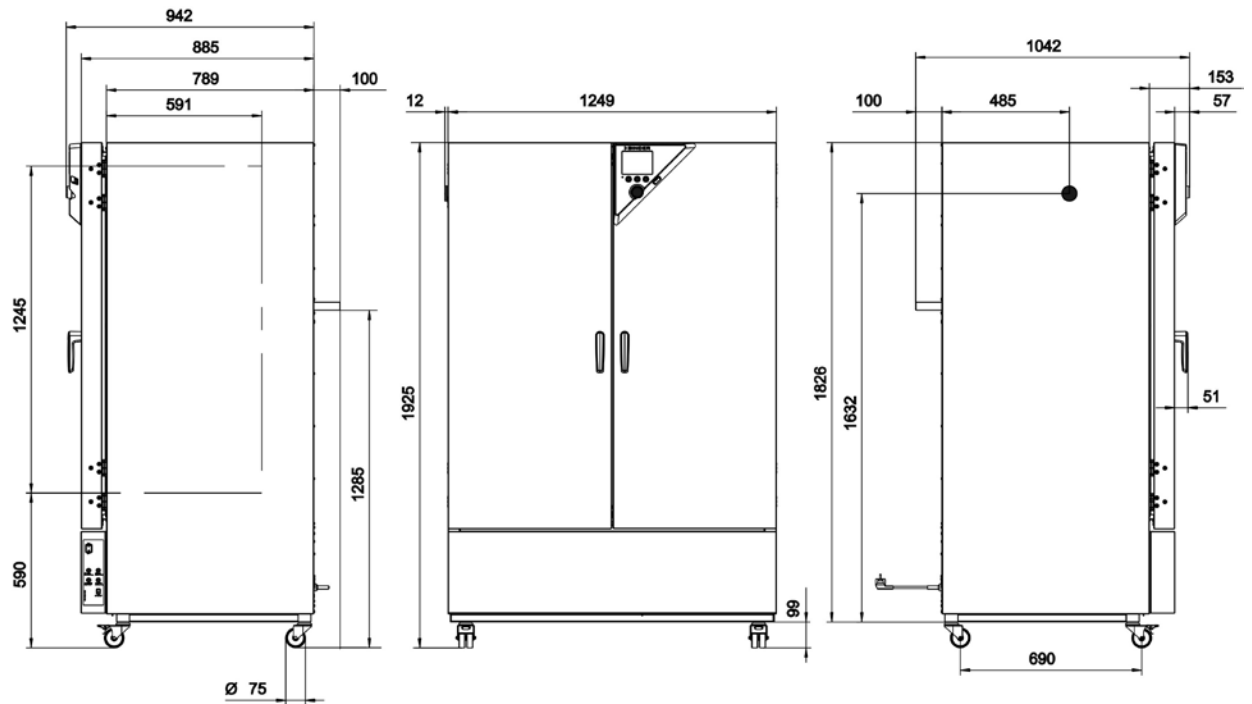

24. Certificates and declarations of conformity

24.1 EU Declaration of Conformity



Best conditions for your success

	EU-Konformitätserklärung / EU Declaration of Conformity / Déclaration de conformité UE / Declaración de conformidad UE / Dichiarazione di conformità UE / Декларация соответствия EU
Hersteller / Manufacturer / Fabricant / Fabricante / Fabbicante / Производитель	BINDER GmbH
Anschrift / Address / Adresse / Dirección / Indirizzo / Адрес	Im Mittleren Ösch 5, 78532 Tuttlingen, Germany
Produkt / Product / Produit / Producto / Prodotto / Продукт	Kühlinkubatoren mit Kompressortechnologie Cooling incubators with compressor technology Incubateurs réfrigérés avec technologie de compresseur Incubadoras refrigeradas con tecnología de compresores Incubatori refrigerati con tecnologia a compressore Инкубаторы с охлаждением с компрессорной технологией
Typenbezeichnung / Type / Type / Tipo / Tipo / Тип	KB 53, KB 115, KB 240, KB 400, KB 720

Die oben beschriebenen Maschinen sind konform mit folgenden EG/EU-Richtlinien (gemäß Veröffentlichung im Amtsblatt der europäischen Kommission):
 The machines described above are in conformity with the following EC/EU Directives (as published in the Official Journal of the European Union):
 Les machines décrites ci-dessus sont conformes aux directives CE/UE suivantes (selon leur publication dans le Journal officiel de l'Union européenne):
 La máquina descrita arriba cumple con las siguientes directivas de la CE/UE (publicados en el Diario oficial de la Unión Europea):
 Le macchine sopra descritte sono conforme alle seguenti direttive CE/UE (secondo la pubblicazione nella Gazzetta ufficiale della Commissione europea):
 Машина, указанная выше, полностью соответствует следующим регламентам ЕС/EU (опубликованным в Официальном журнале Европейского Содружества):

- **2006/42/EC**
 Maschinenrichtlinie 2006/42/EG / Machinery directive 2006/42/EC / Directive Machines 2006/42/EC / Directiva 2006/42/CE (Máquinas) / Direttiva macchine 2006/42/CE / Директива о машинах 2006/42/EC
- **2014/30/EU**
 EMV-Richtlinie 2014/30/EU / EMC Directive 2014/30/EU / Directive CEM 2014/30/UE / Directiva CEM 2014/30/UE / Direttiva EMC 2014/30/UE / Директива ЭМС 2014/30/EU
- **2011/65/EU**
 RoHS-Richtlinie 2011/65/EU / RoHS Directive 2011/65/EU / Directive RoHS 2011/65/UE / Directiva RoHS 2011/65/UE / Direttiva RoHS 2011/65/UE / Директива RoHS 2011/65/EU

1 / 3

BINDER GmbH Postfach 102 D-78502 Tuttlingen Address: BINDER GmbH Im Mittleren Ösch 5 78532 Tuttlingen Germany
 Contact: Phone: +49 (0) 74 62 / 20 05 - 0 | Fax: +49 (0) 74 62 / 20 05 - 100 | info@binder-world.com | www.binder-world.com
 Managing Director: Dipl.-Ing. Peter M. Binder | District court Stuttgart, HRB 727150 | Company head office: Tuttlingen Germany
 Payment Details: Kreissparkasse Tuttlingen Account no.: 2266 BAN: 643 500 70 | IBAN-Code: DE05643 600700 000002266 | SWIFT-Code: SOLA DE S1TUT
 \$-Account no. 2202 611 55 | IBAN-Code: DE7464350070 0220 261155 | SWIFT-Code: SOLA DE S1TUT
 Deutsche Bank Tuttlingen Account no.: 2 138 709 BAN: 653 700 75 | IBAN-Code: DE56853 70075 0213870900 | SWIFT-Code: DEUT DE SS603
 Recycling of old equipment according to WEEE-Reg.-no. DE 37004983

Die oben beschriebenen Maschinen entsprechen aufgrund ihrer Konzipierung und Bauart sowie in der von uns in Verkehr gebrachten Ausführung den einschlägigen grundlegenden Sicherheits- und Gesundheitsanforderungen der genannten EG/EU-Richtlinien.

The machines described above are conform to the mentioned EC/EU directives in regard to the relevant safety and health demands due to their conception and style of construction as well as to the version put onto market by us.

Les machines décrites ci-dessus correspondent aux demandes de sécurité et de santé des directives citées de la CE/UE due à leur conception et construction et dans la réalisation mise sur le marché par nous.

Las máquinas descritas arriba se corresponden con los requisitos básicos pertinentes de seguridad y salud de las citadas directivas de la CE/UE debido a su concepción y fabricación, así como a la realización llevada a cabo por nosotros.

Le macchine sopra descritte sono conforme ai requisiti essenziali di sanità e sicurezza pertinenti delle summenzionate direttive CE/UE in termini di progettazione, tipo di costruzione ed esecuzione messa da noi in circolazione.

Машины описано выше, соответствует указанным директивам ЕС/ЕУ в отношении требований соответствующей безопасности и здоровья по концепции и конструкции так же как и версия, применяемая нами на рынке.

Die oben beschriebenen Maschinen tragen entsprechend die Kennzeichnung CE.

The machines described above, corresponding to this, bear the CE-mark.

Les machines décrits ci-dessus, en correspondance, portent l'indication CE.

Las máquinas descritas arriba, en conformidad, llevan la indicación CE.

Le macchine sopra descritte sono contrassegnate dal marchio CE.

Машины описано выше, в соответствии с изложенным выше маркированы знаком CE.

Die oben beschriebenen Maschinen sind konform mit folgenden harmonisierten Normen:

The machines described above are in conformity with the following harmonized standards:

Les machines décrits ci-dessus sont conformes aux normes harmonisées suivantes:

Las máquinas descritas arriba cumplen con las siguientes normas:

Le macchine sopra descritte sono conforme alle seguenti normative armonizzate:

Машины описано выше, полностью соответствуют следующим стандартам:

Sicherheit / Safety / Sécurité / Seguridad / Sicurezza / Нормативы по безопасности
<ul style="list-style-type: none"> • EN ISO 12100:2010 + Corr. 1:2011 • EN ISO 13732-1:2008 • EN 60204-1:2006 + A1:2009 + Corr. :2010
EMV / EMC / CEM / CEM / EMC / ЭМС
<ul style="list-style-type: none"> • EN 61326-1:2013
RoHS
<ul style="list-style-type: none"> • EN 50581:2012

2 / 3

BINDER GmbH Postfach 102 D-78502 Tuttlingen Address: BINDER GmbH Im Mittleren Ösch 5 78532 Tuttlingen Germany
 Contact: Phone: +49 (0) 74 62 / 20 05 - 0 | Fax: +49 (0) 74 62 / 20 05 - 100 | info@binder-world.com | www.binder-world.com
 Managing Director: Dipl.-Ing. Peter M. Binder | District court Stuttgart, HRB 727150 | Company head office: Tuttlingen Germany
 Payment Details: Kreissparkasse Tuttlingen Account no.: 2266 | BAN: 643 500 70 | IBAN-Code: DE05643 500700 000002266 | SWIFT-Code: SOLA DE S1TUT
 \$-Account no. 2202 611 55 | IBAN-Code: DE7464350070 0220 261155 | SWIFT-Code: SOLA DE S1TUT
 Deutsche Bank Tuttlingen Account no.: 2 138 709 | BAN: 653 700 75 | IBAN-Code: DE56653 70075 0213870900 | SWIFT-Code: DEUT DE SS603
 Recycling of old equipment according to WEEE-Reg.-no. DE 37004983

78532 Tuttlingen, 03.07.2017

BINDER GmbH



P. M. Binder

Geschäftsführender Gesellschafter

Managing Director

Directeur général

Director general

Direttore Generale

Директор



J. Bollaender

Leiter F & E und Dokumentationsbevollmächtigter

Director R & D and documentation representative

Chef de service R&D et autorisé de documentation

Responsable I & D y representante de documentación

Direttore R & D e responsabile della documentazione

Глава департамента R&D представитель документации

3 / 3

BINDER GmbH Postfach 102 D-78502 Tuttlingen **Address:** BINDER GmbH Im Mittleren Ösch 5 78532 Tuttlingen Germany
Contact: Phone: +49 (0) 74 62 / 20 05 - 0 | Fax: +49 (0) 74 62 / 20 05 - 100 | info@binder-world.com | www.binder-world.com
Managing Director: Dipl.-Ing. Peter M. Binder | District court Stuttgart, HRB 727150 | Company head office: Tuttlingen Germany
Payment Details: Kreissparkasse Tuttlingen Account no.: 2266 BAN: 643 500 70 | IBAN-Code: DE05643 500700 000002266 | SWIFT-Code: SOLA DE S1TUT
\$-Account no. 2202 611 55 | IBAN-Code: DE7464350070 0220 261155 | SWIFT-Code: SOLA DE S1TUT
Deutsche Bank Tuttlingen Account no.: 2 138 709 BAN: 653 700 75 | IBAN-Code: DE56653 70075 0213870900 | SWIFT-Code: DEUT DE SS603
Recycling of old equipment according to WEEE-Reg.-no. DE 37004983

24.2 Certificate for the GS mark of conformity of the "Deutsche Gesetzliche Unfallversicherung e.V." (German Social Accident Insurance) DGUV

Bescheinigung
Nr. NV 15127
vom 17.06.2015

 **DGUV Test**
Prüf- und Zertifizierungsstelle
Nahrungsmittel und Verpackung
Fachbereich Nahrungsmittel

GS-Zertifikat

Name und Anschrift des Bescheinigungsinhabers: (Auftraggeber) **Binder GmbH**
Im Mittleren Ösch 5
78532 Tuttlingen

Produktbezeichnung: **Klimaschränke** **Klima- und Kühlbrutschränke**

Typ: KBF P 240, KBF P 720, KBF LQC 240, KBF LQC 720, KBWF 240, KBWF 720, KBF 115, KBF 240, KBF 720, KMF 115, KMF 240, KMF 720, KBW 240, KBW 400, KBW 720, KB 23, KB 53, KB 115, KB 240, KB 400, KB 720, KBF 1020

Prüfgrundlage: GS-NV 5:2013/06 Prüfgrundsätze für Kühl- und Gefriermaschinen für Industrie und Gewerbe

Zugehöriger Prüfbericht: NV 15127

Weitere Angaben: Das Zertifikat bezieht sich auf die im zugehörigen Prüfbericht beschriebene Ausführung des Produkts.

Das geprüfte Baumuster stimmt mit den in § 21 Absatz 1 des Produktsicherheitsgesetzes genannten Anforderungen überein. Der Bescheinigungsinhaber ist berechtigt, das umseitig abgebildete GS-Zeichen an den mit dem geprüften Baumuster übereinstimmenden Produkten anzubringen. Der Bescheinigungsinhaber hat dabei die umseitig aufgeführten Bedingungen zu beachten.

Diese Bescheinigung einschließlich der Berechtigung zur Anbringung des GS-Zeichens ist gültig bis:
16.06.2020

Weiteres über die Gültigkeit, eine Gültigkeitsverlängerung und andere Bedingungen regelt die Prüf- und Zertifizierungsordnung.



P2E04_D
11.14

Deutsche Gesetzliche Unfallversicherung (DGUV) e.V.
Spitzenverband der gewerblichen Berufsgenossenschaften
und der Unfallversicherungsträger der öffentlichen Hand
Vereinsregister-Nr. VR 751 B, Amtsgericht Charlottenburg

DGUV Test Prüf- und Zertifizierungsstelle Nahrungsmittel und Verpackung
Fachbereich Nahrungsmittel
Dynamostraße 7 – 11 • 68165 Mannheim • Deutschland
Telefon: +49 (0) 6 21 44 56 34 30 • Fax: +49 (0) 800 1977 553 16625

Rückseite GS-Zertifikat: NV 15127

GS-Zeichen



Normalausführung

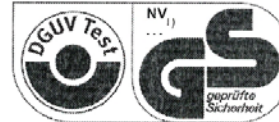

Bei einer Höhe von 20 mm oder weniger
auch zulässige Ausführung

1)Bescheinigungs-Nummer

1. Der Bescheinigungsinhaber hat die Voraussetzungen einzuhalten, die bei der Herstellung des umseitig genannten Produktes zu beachten sind, um die Übereinstimmung mit dem geprüften Baumuster zu gewährleisten.
2. Die Prüf- und Zertifizierungsstelle des Fachbereichs Nahrungsmittel führt in regelmäßigen Abständen Kontrollmaßnahmen zur Überwachung der Herstellung und rechtmäßigen Verwendung des GS-Zeichens durch.
3. Die für die Herstellung verantwortliche Person hat sich zur Einhaltung der Voraussetzungen nach Nummer 1 und Duldung der Kontrollmaßnahmen verpflichtet.
4. Die Prüf- und Zertifizierungsstelle entzieht dem Bescheinigungsinhaber die Zuerkennung des GS-Zeichens, wenn sich die Anforderungen nach § 21 Absatz 1 Produktsicherheitsgesetz geändert haben oder die Voraussetzungen nach Nummer 1 nicht eingehalten werden.
5. Das GS-Zeichen darf nur verwendet und mit ihm darf nur geworben werden, wenn die Voraussetzungen nach § 22 Produktsicherheitsgesetz erfüllt sind.

25. Product registration

Online Product Registration

Register your BINDER now!

www.binder-world.com/register

The registration is free and takes just a few seconds

Advantages:

- ▶ Short response times if service is needed
- ▶ Fair prices when relocating or installing equipment
- ▶ Calibration as required at no charge in case of recalls
- ▶ Free information on news, product upgrades and accessories

Easy registered in 3 steps:



1. List serial number here:

 -

2. Go online: www.binder-world.com/register

3. Register serial number

26. Contamination clearance certificate

26.1 For chambers located outside USA and Canada

Declaration regarding safety and health

Erklärung zur Sicherheit and gesundheitlichen Unbedenklichkeit

The German Ordinance on Hazardous Substances (GefStofV), and the regulations regarding safety at the workplace, require that this form be filled out for all products that are returned to us, so that the safety and the health of our employees can be guaranteed.

Die Sicherheit und Gesundheit unserer Mitarbeiter, die Gefahrstoffverordnung GefStofV und die Vorschriften zur Sicherheit am Arbeitsplatz machen es erforderlich, dass dieses Formblatt für alle Produkte, die an uns zurückgeschickt wird.



Note: A repair is not possible without a completely filled out form.
Ohne Vorliegen des vollständig ausgefüllten Formblattes ist eine Reparatur nicht möglich.

- A completely filled out form must be transmitted via Fax (+49 (0) 7462 2005 93555) or by letter in advance, so that this information is available before the equipment/component part arrives. A second copy of this form must accompany the equipment/component part. In addition, the carrier should be informed.

Eine vollständig ausgefüllte Kopie dieses Formblattes soll per Telefax (Nr. +49 (0) 7462 2005 93555) oder Brief vorab an uns gesandt werden, so dass die Information vorliegt, bevor das Gerät/Bauteil eintrifft. Eine weitere Kopie soll dem Gerät/Bauteil beigelegt sein. Ggf. ist auch die Spedition zu informieren.

- Incomplete information or non-conformity with this procedure will inevitably lead to substantial delays in processing. Please understand the reason for this measure, which lies outside our area of influence and will help us to speed up this procedure.

Unvollständige Angaben oder Nichteinhalten dieses Ablaufs führen zwangsläufig zu beträchtlichen Verzögerungen in der Abwicklung. Bitte haben Sie Verständnis für Maßnahmen, die außerhalb unserer Einflussmöglichkeiten liegen und helfen Sie mit, den Ablauf beschleunigen.

- **Please print and fill out this form completely.**

Bitte unbedingt vollständig ausfüllen!

1.	Unit/ component part / type: / Gerät / Bauteil / Typ:
2.	Serial No./ Serien-Nr.:
3.	Details about utilized substances / biological substances / Einzelheiten über die eingesetzten Substanzen/biologische Materialien:
3.1	Designations / Bezeichnungen:
a)	_____
b)	_____
c)	_____
3.2	Safety measures required for handling these substances / Vorsichtsmaßnahmen beim Umgang mit diesen Stoffen:
a)	_____
b)	_____
c)	_____

3.3	Measures to be taken in case of skin contact or release into the atmosphere / Maßnahmen bei Personenkontakt oder Freisetzung:
a)	_____
b)	_____
c)	_____
d)	_____
3.4	Other important information that must be taken into account / Weitere zu beachtende und wichtige Informationen:
a)	_____
b)	_____
c)	_____
4.	Declaration on the risk of these substances (please checkmark the applicable items) / Erklärung zur Gefährlichkeit der Stoffe (bitte Zutreffendes ankreuzen) :
<input type="checkbox"/>	4.1 For non toxic, non radioactive, biologically harmless materials / für nicht giftige, nicht radioaktive, biologisch ungefährliche Stoffe:
	We hereby guarantee that the above-mentioned unit / component part... / Wir versichern, dass o.g. Gerät/Bauteil...
<input type="checkbox"/>	Has not been exposed to or contains any toxic or otherwise hazardous substances / weder giftige noch sonstige gefährliche Stoffe enthält oder solche anhaften.
<input type="checkbox"/>	That eventually generated reaction products are non-toxic and also do not represent a hazard / auch evtl. entstandene Reaktionsprodukte weder giftig sind noch sonst eine Gefährdung darstellen.
<input type="checkbox"/>	Eventual residues of hazardous substances have been removed / evtl. Rückstände von Gefahrstoffen entfernt wurden.
<input type="checkbox"/>	4.2 For toxic, radioactive, biologically harmful or hazardous substances, or any other hazardous materials / für giftige, radioaktive, biologisch bedenkliche bzw. gefährliche Stoffe oder anderweitig gefährliche Stoffe.
	We hereby guarantee that ... / Wir versichern, dass ...
<input type="checkbox"/>	The hazardous substances, which have come into contact with the above-mentioned equipment/component part, have been completely listed under item 3.1 and that all information in this regard is complete / die gefährlichen Stoffe, die mit dem o.g. Gerät/Bauteil in Kontakt kamen, in 3.1 aufgelistet sind und alle Angaben vollständig sind.
<input type="checkbox"/>	That the unit /component part has not been in contact with radioactivity / das Gerät/Bauteil nicht mit Radioaktivität in Berührung kam
5.	Kind of transport / transporter / Transportweg/Spediteur:
	Transport by (means and name of transport company, etc.) / Versendung durch (Name Spediteur o.ä.)

	Date of dispatch to BINDER GmbH / Tag der Absendung an BINDER GmbH:

We hereby declare that the following measures have been taken / Wir erklären, dass folgende Maßnahmen getroffen wurden:

- Hazardous substances were removed from the unit including component parts, so that no hazard exists for any person in the handling or repair of these items / das Gerät/Bauteil wurde von Gefahrstoffen befreit, so dass bei Handhabung/Reparaturen für die betreffenden Person keinerlei Gefährdung besteht
- The unit was securely packaged and properly identified / das Gerät wurde sicher verpackt und vollständig gekennzeichnet.
- Information about the hazardousness of the shipment (if required) has been provided to the transporter / der Spediteur wurde (falls vorgeschrieben) über die Gefährlichkeit der Sendung informiert.

We hereby commit ourselves and guarantee that we will indemnify BINDER GmbH for all damages that are a consequence of incomplete or incorrect information provided by us, and that we will exempt BINDER GmbH from eventual damage claims by third parties. / Wir versichern, dass wir gegenüber BINDER für jeden Schaden, der durch unvollständige und unrichtige Angaben entsteht, haften und BINDER gegen eventuell entstehende Schadenansprüche Dritter freistellen.

We are aware that, in accordance with Article 823 of the German Civil Code (BGB), we are directly liable with regard to third parties, in this instance especially the employees of BINDER GmbH, who have been entrusted with the handling / repair of the unit / component. / Es ist uns bekannt, dass wir gegenüber Dritten – hier insbesondere mit der Handhabung/Reparatur des Geräts/des Bauteils betraute Mitarbeiter der Firma BINDER – gemäß §823 BGB direkt haften

Name: _____

Position/Title: _____

Date / Datum: _____

Signature / Unterschrift: _____

Company stamp / Firmenstempel:



Equipment that is returned to the factory for repair must be accompanied by a completely filled out contamination clearance certificate. For service and maintenance on site, such a contamination clearance certificate must be submitted to the service technician before the start of any work. No repair or maintenance of the equipment is possible, without a properly filled out contamination clearance certificate.

26.2 For chambers in USA and Canada

Product Return Authorization Request

Please complete this form and the Customer Decontamination Declaration (next 2 pages) and attach the required pictures. E-mail to: IDL_SalesOrderProcessing_USA@binder-world.com

After we have received and reviewed the complete information we will decide on the issue of a RMA number. Please be aware that size specifications, voltage specifications as well as performance specifications are available on the internet at www.binder-world.us at any time.

Take notice of shipping laws and regulations.

	Please fill:	
Reason for return request	<input type="radio"/> Duplicate order	
	<input type="radio"/> Duplicate shipment	
	<input type="radio"/> Demo	<i>Page one completed by sales</i>
	<input type="radio"/> Power Plug / Voltage	115V / 230 V / 208 V / 240V
	<input type="radio"/> Size does not fit space	
	<input type="radio"/> Transport Damage	Shock watch tripped? (<i>pictures</i>)
	<input type="radio"/> Other (specify below)	

Is there a replacement PO?	<input type="radio"/> Yes <input type="radio"/> No	
<i>If yes -> PO #</i>		
<i>If yes -> Date PO placed</i>		
Purchase order number		
BINDER model number		
BINDER serial number		
Date unit was received		
Was the unit unboxed?	<input type="radio"/> Yes <input type="radio"/> No	
Was the unit plugged in?	<input type="radio"/> Yes <input type="radio"/> No	
Was the unit in operation?	<input type="radio"/> Yes <input type="radio"/> No	
<i>Pictures of unit attached?</i>	<input type="radio"/> Yes <input type="radio"/> No	Pictures have to be attached!
<i>Pictures of Packaging attached?</i>	<input type="radio"/> Yes <input type="radio"/> No	

	Customer Contact Information	Distributor Contact Information
Name		
Company		
Address		
Phone		
E-mail		

Customer (End User) Decontamination Declaration

Health and Hazard Safety declaration

To protect the health of our employees and the safety at the workplace, we require that this form is completed by the user for all products and parts that are returned to us. (Distributors or Service Organizations cannot sign this form)

	<p>NO RMA number will be issued without a completed form. Products or parts returned to our NY warehouse without a RMA number will be refused at the dock.</p>
---	--

A second copy of the completed form must be attached to the outside of the shipping box.

1.	Unit/ component part / type:
2.	Serial No.
3.	List any exposure to hazardous liquids, gasses or substances and radioactive material
3.1	List with MSDS sheets attached where available or needed (if there is not enough space available below, please attach a page):
a)	_____
b)	_____
c)	_____
3.2	Safety measures required for handling the list under 3.1
a)	_____
b)	_____
c)	_____
3.3	Measures to be taken in case of skin contact or release into the atmosphere:
a)	_____
b)	_____
c)	_____
d)	_____
3.4	Other important information that must be considered:
a)	_____
b)	_____
c)	_____

4. Declaration of Decontamination

For toxic, radioactive, biologically and chemically harmful or hazardous substances, or any other hazardous materials.

We hereby guarantee that

4.1 Any hazardous substances, which have come into contact with the above-mentioned equipment / component part, have been completely listed under item 3.1 and that all information in this regard is complete.

4.2 That the unit /component part has not been in contact with radioactivity

4.3 Any Hazardous substances were removed from the unit / component part, so that no hazard exists for a persons in the shipping, handling or repair of these returned unit

4.4 The unit was securely packaged in the original undamaged packaging and properly identified on the outside of the packaging material with the unit designation, the RMA number and a copy of this declaration.

4.5 Shipping laws and regulations have not been violated.

I hereby commit and guarantee that we will indemnify BINDER Inc. for all damages that are a consequence of incomplete or incorrect information provided by us, and that we will indemnify and hold harmless BINDER Inc. from eventual damage claims by third parties..

Name: _____

Position: _____

Company: _____

Address: _____

Phone #: _____

Email: _____

Date: _____

Signature: _____



Equipment returned to the NY warehouse for repair must be accompanied by a completed customer decontamination declaration. For service and maintenance works on site, such a customer decontamination declaration must be submitted to the service technician before the start of work. No repair or maintenance of the equipment is possible without a completed form.