

Operating Manual

FP – Drying and heating ovens with forced convection and program functions

with microprocessor program controller RD3

Model	Model version	Art. No.
FP 53 (E1.1)	FP053-230V	9010-0153, 9110-0153
FP 53-UL (E1.1)	FP053UL-120V	9010-0175, 9110-0175
FP 115 (E1.1)	FP115-230V	9010-0255, 9110-0255
FP 115-UL (E1.1)	FP115UL-120V	9010-0262, 9110-0262
FP 240 (E1.1)	FP240-230V	9010-0263, 9110-0263
FP 240-UL (E1.1)	FP240UL-120V	9010-0264, 9110-0264
FP 400 (E1.1)	FP400-230V	9010-0265, 9110-0265
FP 400-UL (E1.1)	FP400UL-120V	9010-0266, 9110-0266
FP 720 (E1.1)	FP720-230V	9010-0267, 9110-0267
FP 720-UL (E1.1)	FP720UL-120V	9010-0268, 9110-0268

BINDER GmbH

- ▶ Address: Post office box 102, 78502 Tuttlingen, Germany ▶ Phone: +49 7462 2005 0
- ▶ Fax: +49 7462 2005 100 ▶ Internet: <http://www.binder-world.com>
- ▶ E-mail: info@binder-world.com ▶ Service Hotline: +49 7462 2005 555
- ▶ Service Fax: +49 7462 2005 93 555 ▶ Service E-Mail: service@binder-world.com
- ▶ Service Hotline USA: +1 866 885 9794 or +1 631 224 4340 x3
- ▶ Service Hotline Asia Pacific: +852 390 705 04 or +852 390 705 03
- ▶ Service Hotline Russia and CIS: +7 495 988 15 16

Contents

1. SAFETY	4
1.1 Legal considerations	4
1.2 Structure of the safety instructions.....	4
1.2.1 Signal word panel.....	4
1.2.2 Safety alert symbol.....	5
1.2.3 Pictograms.....	5
1.2.4 Word message panel structure	6
1.3 Localization / position of safety labels on the chamber	6
1.4 Type plate	7
1.5 General safety instructions on installing and operating the chambers	8
1.6 Intended use	10
2. CHAMBER DESCRIPTION	11
2.1 Chamber overview	12
2.2 Control panel.....	13
3. SCOPE OF DELIVERY, TRANSPORTATION, STORAGE, AND INSTALLATION	13
3.1 Unpacking, and checking equipment and scope of delivery.....	13
3.2 Guidelines for safe lifting and transportation	14
3.3 Storage.....	14
3.4 Location of installation and ambient conditions	15
4. INSTALLATION OF THE EQUIPMENT	16
4.1 Electrical connection	16
4.2 Connection to a suction plant (optional)	16
5. START UP	17
5.1 Air change	17
5.2 Settings at the RD3 program controller	17
5.3 General indications	18
6. FIXED VALUE ENTRY MODE	20
7. WEEK PROGRAM EDITOR	21
7.1 Program table template for Week program Editor	24
8. PROGRAM EDITOR	25
8.1 Selecting between set-point ramp and set-point step.....	25
8.1.1 Programming with setting “Ramp” (default setting).....	25
8.1.2 Programming with setting “step”	27
8.1.3 General advice for the programming of temperature transitions	28
8.2 Set-point entry for program operation.....	28
8.3 Program table template.....	32
8.4 Deleting a program section	33
9. PROGRAM START LEVEL	34
10. USER LEVEL	36
11. EXAMPLE PROGRAMMING FOR THE WEEK PROGRAM EDITOR	43
11.1 Desired time function	43
11.2 Proceeding overview.....	43
11.3 Proceeding in detail.....	43
12. EXAMPLE PROGRAMMING FOR THE PROGRAM EDITOR	49
12.1 Desired time function	49



12.2	Proceeding overview.....	49
12.3	Proceeding in detail.....	50
13.	BEHAVIOR AT FAILURES	56
13.1	Behavior after power failure	56
13.2	Alarm messages	56
14.	TEMPERATURE SAFETY DEVICES.....	56
14.1	Temperature safety device class 2 (DIN 12880)	56
14.2	Temperature safety device class 3.1 (DIN 12880) (option).....	57
15.	OPTIONS.....	59
15.1	Communication software APT-COM™ 3 DataControlSystem (option)	59
15.2	Data logger kit (option).....	59
15.3	Additional measuring channel for digital object temperature indicator with flexible temperature sensor Pt 100 (option).....	59
15.4	Analog output for temperature (option).....	60
15.5	Zero-voltage relay outputs via operation lines (option).....	60
15.6	HEPA fresh air filter (option)	60
15.7	Mostly gas-tight version (option for FP 53 and FP 115)	61
15.8	Inert gas connection with mostly gas-tight version (option for FP 53 and FP 115)	61
16.	MAINTENANCE, CLEANING, AND SERVICE	63
16.1	Maintenance intervals, service.....	63
16.2	Cleaning and decontamination	64
16.2.1	Cleaning	64
16.2.2	Decontamination	65
16.3	Sending back the chamber to BINDER GmbH	66
17.	DISPOSAL.....	67
17.1	Disposal of the transport packing	67
17.2	Decommissioning.....	67
17.3	Disposal of the chamber in the Federal Republic of Germany	68
17.4	Disposal of the chamber in the member states of the EC except for the Federal Republic of Germany	69
17.5	Disposal of the chamber in non-member states of the EC	70
18.	TROUBLESHOOTING	71
19.	TECHNICAL DESCRIPTION.....	72
19.1	Factory calibration and adjustment.....	72
19.2	Over current protection	72
19.3	Definition of usable space.....	72
19.4	Technical data.....	73
19.5	Equipment and options (extract).....	74
19.6	Accessories and spare parts (extract)	76
19.7	Dimensions FP 53.....	77
19.8	Dimensions FP 115.....	78
19.9	Dimensions FP 240.....	79
19.10	Dimensions FP 400.....	80
19.11	Dimensions FP 720.....	81
20.	EU DECLARATION OF CONFORMITY	82
21.	PRODUCT REGISTRATION	84
22.	CONTAMINATION CLEARANCE CERTIFICATE	85
22.1	For chambers located outside USA and Canada	85
22.2	For chambers in USA and Canada.....	88

Dear customer,

For the correct operation of the chambers, it is important that you read this operating manual completely and carefully and observe all instructions as indicated. Failure to read, understand and follow the instructions may result in personal injury. It can also lead to damage to the chamber and/or poor equipment performance.

1. Safety

This operating manual is part of the components of delivery. Always keep it handy for reference. The device should only be operated by laboratory personnel especially trained for this purpose and familiar with all precautionary measures required for working in a laboratory. Observe the national regulations on minimum age of laboratory personnel. To avoid injuries and damage observe the safety instructions of the operating manual.

	 WARNING
	<p>Failure to observe the safety instructions. Serious injuries and chamber damage.</p> <ul style="list-style-type: none"> ➤ Observe the safety instructions in this operating manual. ➤ Carefully read the complete operating instructions of the chambers.

1.1 Legal considerations

This operating manual contains information necessary for the intended use, correct installation, start-up and operation, and for the maintenance of the chamber.

Understanding and observing the instructions in this operating manual are prerequisites for hazard-free use and safety during operation and maintenance. In no event shall BINDER be held liable for any damages, direct or incidental arising out of or related to the use of this manual.

This operating manual cannot cover all conceivable applications. If you would like additional information, or if special problems arise that you feel are not sufficiently addressed in this manual, please ask your dealer or contact us directly.

Furthermore, we emphasize that the contents of this operating manual are not part of an earlier or existing agreement, promise, or legal relationship, nor do they modify such a relationship. All obligations on the part of BINDER derive from the respective purchase contract, which also contains the entire and exclusively valid statement of warranty administration. The statements in this manual neither augment nor restrict the contractual warranty provisions.

1.2 Structure of the safety instructions

In this operating manual, the following harmonized denominations and symbols indicate dangerous situations in accordance with ISO 3864-2 and ANSI Z535.6.

1.2.1 Signal word panel

Depending on the seriousness and probability of the consequences, dangers are identified with a signal word, the corresponding safety color, and if appropriate, the safety alert symbol.

 DANGER
<p>Indicates an imminently hazardous situation that, if not avoided, will result in death or serious (irreversible) injury.</p>

 WARNING
<p>Indicates a potentially hazardous situation which, if not avoided, could result in death or serious (irreversible) injury.</p>

CAUTION

Indicates a potentially hazardous situation which, if not avoided, may result in moderate or minor (reversible) injury.

CAUTION

Indicates a potentially hazardous situation which, if not avoided, may result in damage to the product and/or its functions or of a property in its proximity.

1.2.2 Safety alert symbol



Use of the safety alert symbol indicates **risk of injury**.

Observe all measures that are marked with the safety alert symbol in order to avoid death or injury.

1.2.3 Pictograms

Warning signs			
Electrical hazard	Hot surface	Explosive atmosphere	Stability hazard
Lifting hazard	Suffocation hazard	Pollution Hazard	Risk of corrosion and / or chemical burns
Biohazard	Pollution Hazard		
Mandatory action signs			
Mandatory regulation	Read operating instructions	Disconnect the power plug	Lift with several persons
Lift with mechanical assistance	Environment protection	Wear protective gloves	Wear safety goggles
Prohibition signs			
Do NOT touch	Do NOT spray with water		



Information to be observed in order to ensure optimum function of the product.

1.2.4 Word message panel structure

Type / cause of hazard.



Possible consequences.

- ⊘ Instruction how to avoid the hazard: prohibition
- Instruction how to avoid the hazard: mandatory action

Observe all other notes and information not necessarily emphasized in the same way, in order to avoid disruptions which could result in direct or indirect injury or property damage.

1.3 Localization / position of safety labels on the chamber

The following labels are located on the chamber:

Pictograms (Warning signs)	Service label
 <p>Hot surface</p> <ul style="list-style-type: none"> • Outer chamber door • On chamber rear next to the exhaust duct 	
 <p>Read operating manual</p> <ul style="list-style-type: none"> • UL chambers: outer chamber door 	

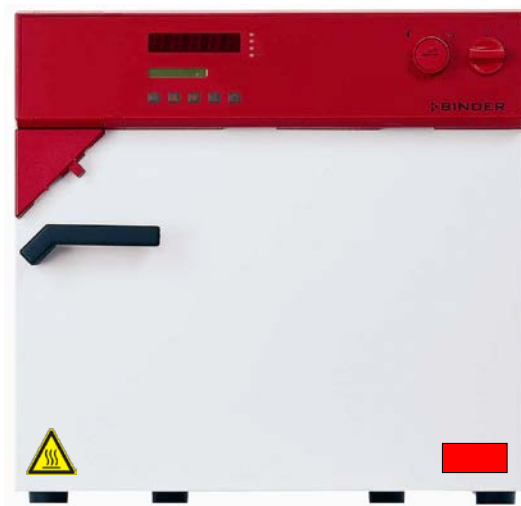

FP 53



FP 53-UL

Figure 1: Position of labels on the chamber front (examples)



Keep safety labels complete and legible.

Replace safety labels that are no longer legible. Contact BINDER Service.

1.4 Type plate

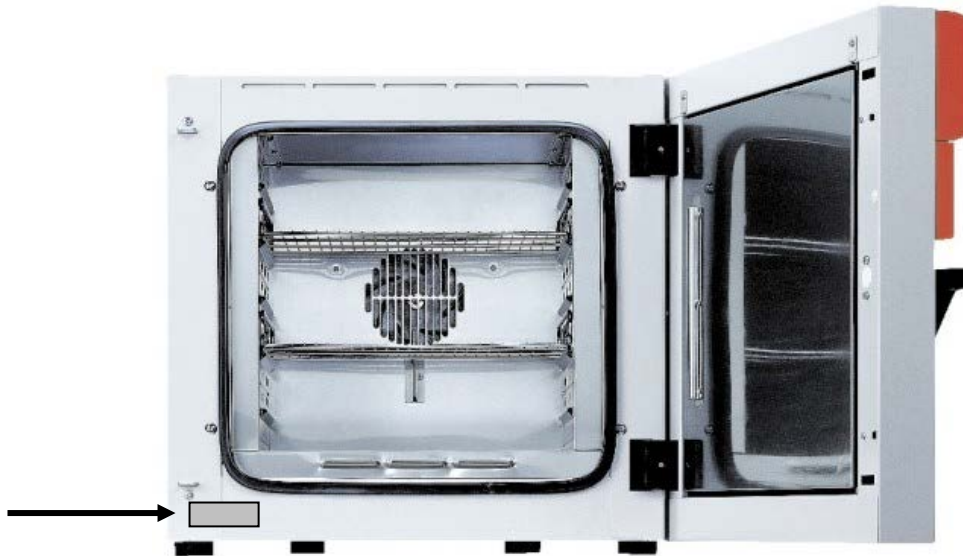





Figure 2: Position of the type plate



Figure 3: Type plate (example of FP 115 regular chamber)

Indications of the type plate (example)		Information
BINDER		Manufacturer: BINDER GmbH
FP 115		Model
Drying and heating oven		Chamber name
Serial No.	000000000000	Serial no. of the chamber
Built	2017	Year of construction
Nominal temperature	300 °C 572°F	Nominal temperature
IP protection	20	IP type of protection acc. to EN 60529
Temp. safety device	DIN 12880	Temperature safety device acc. to standard DIN 12880
Class	2.0	Class of temperature safety device
Art. No.	9010-0255	Art. no. of the chamber
Project No.	---	Optional: Special application acc. to project no.
1,60 kW		Nominal power
7,0 A		Nominal current
230 V / 50 Hz		Nominal voltage ± 10% at the indicated power frequency
230 V / 60 Hz		
1 N ~		Current type

Symbol on the type plate	Information
	CE conformity marking
	Electrical and electronic equipment manufactured / placed on the market in the EU after 13 August 2005 and to be disposed of in a separate collection according to directive 2012/19/EU on waste electrical and electronic equipment (WEEE).
	The chamber is certified according to Customs Union Technical Regulation (CU TR) for the Eurasian Economic Union (Russia, Belarus, Armenia, Kazakhstan Kyrgyzstan).
 (FP-UL only)	The equipment is certified by Underwriters Laboratories Inc. [®] according to standards CAN/CSA-C22.2 No. 61010-1, 2 nd Edition, 2004-07 (Electrical Equipment for Measurement, Control, and Laboratory Use; Part 1: General Requirements); UL 61010-1, 2 nd Edition, 2005-07-22 (Electrical Equipment for Measurement, Control, and Laboratory Use; Part 1: General Requirements); IEC 61010-1:2001, 2 nd Edition and IEC 61010-2-10 (Particular Requirements for Laboratory Equipment for the heating of materials).

1.5 General safety instructions on installing and operating the chambers



With regard to operating the chambers and to the installation location, please observe the DGUV guidelines 213-850 on safe working in laboratories (formerly BGI/GUV-I 850-0, BGR/GUV-R 120 or ZH 1/119, issued by the employers' liability insurance association) (for Germany).

BINDER GmbH is only responsible for the safety features of the chamber provided skilled electricians or qualified personnel authorized by BINDER perform all maintenance and repair, and if components relating to chamber safety are replaced in the event of failure with original spare parts.



To operate the chamber, use only original BINDER accessories or accessories from third-party suppliers authorized by BINDER. The user is responsible for any risk caused by using unauthorized accessories.

	CAUTION
	<p>Danger of overheating.</p> <p>Damage to the chamber.</p> <ul style="list-style-type: none"> ⊘ Do NOT install the chamber in unventilated recesses. ➤ Ensure sufficient ventilation for dispersal of the heat.

Do not operate the chambers in hazardous locations.

	 DANGER
	<p>Explosion hazard.</p> <p>Danger of death.</p> <ul style="list-style-type: none"> ⊘ Do NOT operate the chamber in potentially explosive areas. ➤ KEEP explosive dust or air-solvent mixtures AWAY from the chamber.

The chambers do not dispose of any measures of explosion protection.

	 DANGER
	<p>Explosion hazard. Danger of death.</p> <ul style="list-style-type: none"> ⊘ Do NOT introduce any combustible or explosive substance at working temperature into the drying and heating oven. ⊘ NO explosive dust or air-solvent mixture in the inner chamber.



Any solvent contained in the charging material must not be explosive or inflammable. I.e., irrespective of the solvent concentration in the steam room, NO explosive mixture with air must form. The temperature inside the chamber must lie below the flash point or below the sublimation point of the charging material. Familiarize yourself with the physical and chemical properties of the charging material, as well as the contained moisture constituent and its behavior with the addition of heat energy.

Familiarize yourself with any potential health risks caused by the charging material, the contained moisture constituent or by reaction products which may arise during the temperature process. Take adequate measures to exclude such risks prior to putting the chamber into operation.

	 DANGER
	<p>Electrical hazard. Danger of death.</p> <ul style="list-style-type: none"> ⊘ The chamber must NOT become wet during operation or maintenance.

The chambers were produced in accordance with VDE regulations and were routinely tested in accordance to VDE 0411-1 (IEC 61010-1).

During and shortly after operation, the temperature of the inner surfaces almost equals the set-point.

	 CAUTION
	<p>The inner chamber, the exhaust duct, the door window (option), the door gaskets, and the access ports will become hot during operation.</p> <p>Danger of burning.</p> <ul style="list-style-type: none"> ⊘ Do NOT touch the inner surfaces, the exhaust duct, the door window, the access ports, the door gaskets or the charging material during operation.

1.6 Intended use

The drying and heating ovens with forced convection and program functions FP are suitable for drying and heat treatment of solid or pulverized charging material, as well as bulk material, using the supply of heat. The ovens are suitable for harmless charging material. A mixture of any component of the charging material with air must NOT be explosive. The operating temperature must lie below the flash point or below the sublimation point of the charging material. Any component of the charging material must NOT be able to release toxic gases.

Other applications are not approved.



Do NOT use the chamber for drying processes when large quantities of vapor would form and result in condensation.

The chambers are not classified as medical devices as defined by the Medical Device Directive 93/42/EEC.

	Due to the special demands of the Medical Device Directive (MDD), these ovens are not qualified for sterilization of medical devices as defined by the directive 93/42/EEG.
---	---

	Observing the instructions in this operating manual and conducting regular maintenance work (chap. 16.1) is part of the intended use.
---	---

The chambers do not dispose of any measures of explosion protection.

	 DANGER
	<p>Explosion or implosion hazard.</p> <p>Danger of poisoning.</p> <p>Danger of death.</p> <ul style="list-style-type: none"> ⊘ Do NOT introduce any substance combustible or explosive at working temperature into the chamber, in particular no energy sources such as batteries or lithium-ion batteries. ⊘ NO explosive dust or air-solvent mixture in the inner chamber. ⊘ Do NOT introduce any substance which could lead to release of toxic gases.

	The charging material shall not contain any corrosive ingredients that may damage the machine components made of stainless steel, aluminum, and copper. Such ingredients include in particular acids and halides. Any corrosive damage caused by such ingredients is excluded from liability by BINDER GmbH.
---	--

In case of foreseeable use of the device there is no risk for the user through the integration of the chamber into systems or by special environmental or operating conditions in the sense of EN 61010-1:2010. For this, the intended use of the chamber and all its connections must be observed.

2. Chamber description

BINDER drying and heating ovens with forced convection and program functions FP are equipped with the electronic program controller RD3 with digital display. This allows programming of temperature cycles and an individual fan speed setting for each program section. The chamber provides almost unlimited possibilities for adaptation to individual customer requirements based upon extensive programming options and on the week program timer and real time clock of the controller.

The APT.line™ preheating chamber system guarantees high level of spatial and time-based temperature precision, thanks to the direct and distributed air circulation into the interior. The fan supports exact attainment and maintenance of the desired temperature accuracy. The fan speed is digitally adjustable from 0 % to 100%.

All chamber functions are easy and comfortable to use thanks to their clear arrangement. Major features are easy cleaning of all chamber parts and avoidance of undesired contamination.

The inner chamber, the pre-heating chamber and the inside of the doors are all made of stainless steel V2A (German material no. 1.4301, US equivalent AISI 304). When operating the chamber at temperatures above 150 °C, the influence of the oxygen in the air may cause coloration of the metallic surfaces (yellowish-brown or blue) by natural oxidation processes. These colorations are harmless and will in no way impair the function or quality of the chamber. The housing is RAL 7035 powder-coated. All corners and edges are completely coated.

The chambers are regularly equipped with a serial interface RS 422 for computer communication, e.g. via the communication software APT-COM™ 3 DataControlSystem (option, chap. 15.1). For further options, see chap. 19.5.

The model FP 720 is equipped with four castors. Both front castors can be locked by brakes.

The chambers can be operated in a temperature range of 5 °C / 9 °F above ambient temperature up to 300 °C / 572 °F.

2.1 Chamber overview

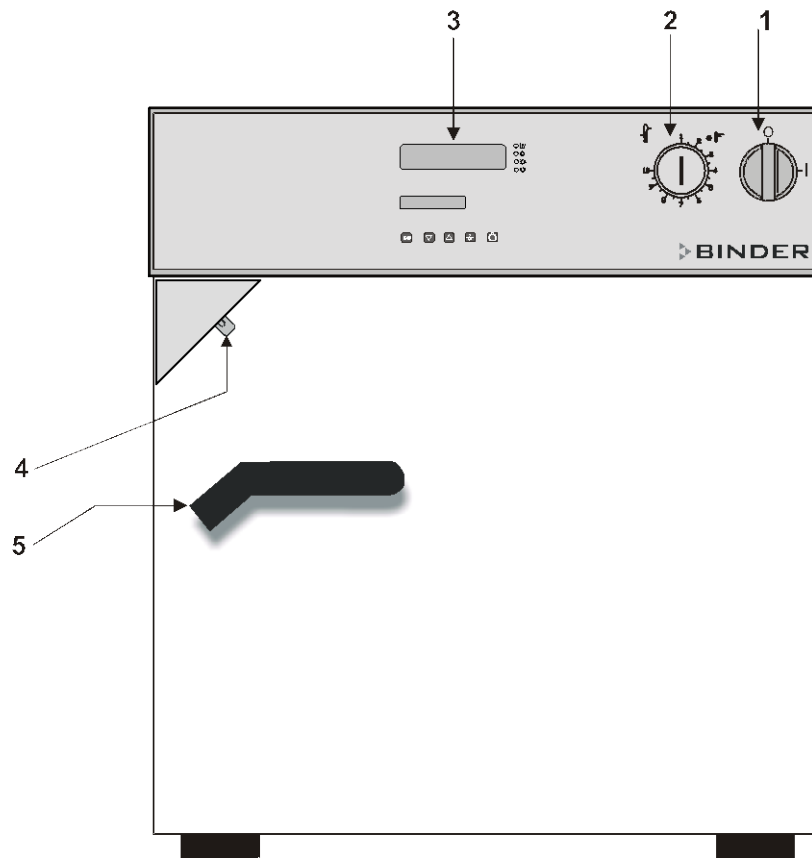

Figure 4: Drying and heating oven FP (example: model FP 53)

- (1) Main power switch on/off
- (2) Safety device class 2 or class 3.1 (option)
- (3) Program controller RD3
- (4) Lever for ventilation slide
- (5) Door handle

2.2 Control panel

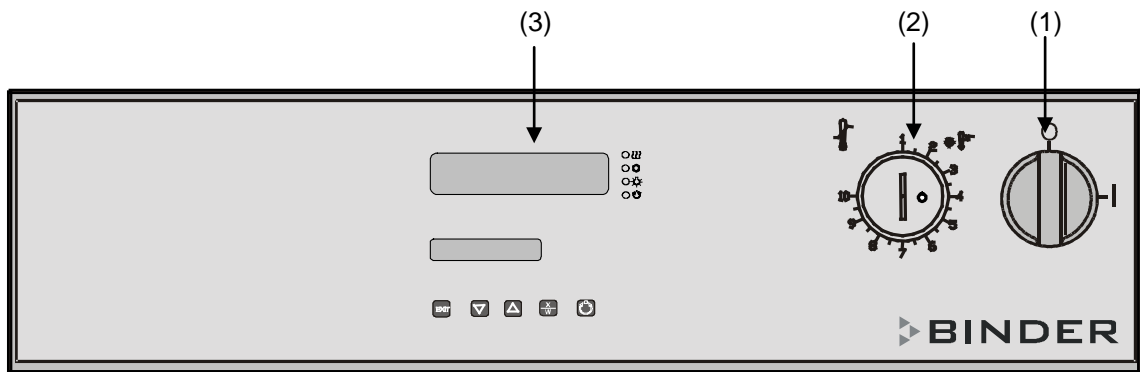

Figure 5: Control panel of standard chamber

- (1) Main power switch on/off
- (2) Safety device class 2
- (3) Program controller RD3





3. Scope of delivery, transportation, storage, and installation

3.1 Unpacking, and checking equipment and scope of delivery

After unpacking, please check the chamber and its optional accessories, if any, based on the delivery note for completeness and for transportation damage. If transportation damage has occurred, inform the carrier immediately.

The final tests of the manufacturer may cause traces of the racks on the inner surfaces. This has no impact on the function and performance of the chamber.

Please remove any transportation protection devices and adhesives in/on the chamber and on the doors and take out the operating manuals and accessory equipment.

 CAUTION	
   	<p>Sliding or tilting the chamber. Damage to the chamber.</p> <p>Risk of injury by lifting heavy loads.</p> <ul style="list-style-type: none"> Ø Do NOT lift or transport the chamber using the door handle or the door. Ø Do NOT lift chambers 400 and 720 by hand. ➤ Lift the chamber size 53 and 115 from the pallet at its four lower corners with the aid of 2 people, chamber size 240 with the aid of 4 people Ø Lift chambers 400 and 720 from the pallet using technical devices (fork lifter). Set the fork lifter only from the rear in the middle of the chamber. Make sure to place all the lateral supports of the chamber on the forks.

If you need to return the chamber, please use the original packing and observe the guidelines for safe lifting and transportation (chap. 3.2).

For disposal of the transport packing, see chap. 17.1.





Note on second-hand chambers (Ex-Demo-Units):

Second-hand chambers are chambers that have been used for a short time for tests or exhibitions. They are thoroughly tested before resale. BINDER guarantees the technically flawless state of the chamber.

Second-hand chambers are marked as such with a sticker on the chamber door. Please remove the sticker before commissioning the chamber.

3.2 Guidelines for safe lifting and transportation

The front castors of chambers size 720 can be blocked by brakes. Please move the chambers with castors only when empty and on an even surface, otherwise the castors may be damaged. Respect the advice for temporal decommissioning (chap. 17.2).

   	 CAUTION
	<p>Sliding or tilting the chamber.</p> <p>Damage to the chamber.</p> <p>Risk of injury by lifting heavy loads.</p> <ul style="list-style-type: none"> ➤ Transport the chamber in its original packaging only. ➤ Secure the chamber with transport straps for transport. ⊘ Do NOT lift or transport the chamber using the door handle or the door. ⊘ Do NOT lift chambers 400 and 720 by hand. ➤ Lift chamber size 53 and 115 at its four lower corners with the aid of 2 people, chamber size 240 with the aid of 4 people, and place it on a transport pallet with wheels. Push the pallet to the desired site and then lift the chamber from the pallet at its four lower corners. ➤ Place chambers size 400 and 720 using technical devices (fork lifter) on the transport pallet. Set the fork lifter only from the rear in the middle of the chamber. Make sure to place all the lateral supports of the chamber on the forks. ⊘ Transport chambers size 400 and 720 ONLY with the original transport pallet. Set the fork lifter only to the pallet. Without the pallet the chamber is in imminent danger of overturning.

- Permissible ambient temperature range during transport: -10 °C to +60 °C / 14 °F to 140 °F.

You can order transport packing and pallets for transportation purposes from BINDER Service.

3.3 Storage

Intermediate storage of the chamber is possible in a closed and dry room. Observe the guidelines for temporary decommissioning (chap. 17.2).

- Permissible ambient temperature range during storage: -10 °C to +60 °C / 14 °F to 140 °F.
- Permissible ambient humidity: max. 70 % r.H., non-condensing

If following storage in a cold location the chamber is transferred to the installation site for start-up, condensation may form. Wait at least one hour until the chamber has attained ambient temperature and is completely dry.

3.4 Location of installation and ambient conditions

Set up the chamber on an even and non-flammable surface, free from vibration and in a well-ventilated, dry location and align it using a spirit level. The site of installation must be capable of supporting the chamber's weight (see technical data, chap. 19.4). The chambers are designed for setting up inside a building (indoor use).

	CAUTION
	<p>Danger of overheating. Damage to the chamber.</p> <ul style="list-style-type: none"> ⊘ Do NOT set up chambers in non-ventilated recesses. ➤ Ensure sufficient ventilation for dispersal of the heat.

- Permissible ambient temperature range during operation: +18 °C up to +40 °C / 64.4 °F to 104 °F. At elevated ambient temperature values, fluctuations in temperature can occur.

	<p>The ambient temperature should not be substantially higher than the indicated ambient temperature of +22 °C +/- 3°C / 71.6 °F ± 5.4 °F to which the specified technical data relate. For other ambient conditions, deviations from the indicated data are possible.</p>
---	--

- Permissible ambient humidity: 70 % r.H. max., non-condensing.
- Installation height: max. 2000 m / 6562 ft. above sea level.

When placing several chambers of the same size side by side, maintain a minimum distance of 250 mm / 9.84 in between each chamber. Wall distances: rear 100 mm / 3.94 in, sides 160 mm / 6.30 in. Spacing above the chamber of at least 100 mm / 3.94 in must also be accounted for.



Two devices up to size 115l can be stacked on top of each other. For this purpose, place rubber pads under all four feet of the upper chamber to prevent the device from slipping.

	CAUTION
	<p>Sliding or tilting of the upper chamber. Damage to the chambers.</p> <ul style="list-style-type: none"> ➤ When stacking, place rubber pads under all four feet of the upper chamber.

To completely separate the chamber from the power supply, you must disconnect the power plug. Install the chamber in a way that the power plug is easily accessible and can be easily pulled in case of danger.

For the user there is no risk of temporary overvoltages in the sense of EN 61010-1:2010.

The chamber must NOT be installed and operated in hazardous locations.

	 DANGER
	<p>Explosion hazard. Danger of death.</p> <ul style="list-style-type: none"> ⊘ Do NOT operate the chamber in potentially explosive areas. ➤ KEEP explosive dust or air-solvent mixtures AWAY from the vicinity of the chamber.

4. Installation of the equipment

4.1 Electrical connection

The chambers are supplied ready for connection and come with a fixed power connection cable.

Model	Power plug of the power cable	Nominal voltage $\pm 10\%$ at the indicated power frequency	Current type	Length of power cable
FP 53 FP 115 FP 240	Shockproof plug	230 V at 50 Hz 230 V at 60 Hz	1N~	1800 mm
FP 400 FP 720	CEE plug 5 poles	400 V at 50 Hz 400 V at 60 Hz	3N~	2700 mm
FP 53-UL FP 115-UL	NEMA 5-20P	115 V at 60 Hz	1N~	1800 mm
FP 240-UL FP 400-UL FP 720-UL	NEMA L21-20P	208 V at 60 Hz	3N~	2700 mm

- The domestic socket must also provide a protective conductor. Make sure that the connection of the protective conductor of the domestic installations to the chamber's protective conductor meets the latest technology. The protective conductors of the socket and plug must be compatible!
- Prior to connection and start-up, check the power supply voltage. Compare the values to the data specified on the type plate of the chamber (chamber front behind the door, bottom left-hand, chap. 1.4).
- When connecting, please observe the regulations specified by the local electricity supply company and as well as the VDE directives (for Germany). We recommend the use of a residual current circuit breaker.
- Pollution degree (acc. to IEC 61010-1): 2
- Over-voltage category (acc. to IEC 61010-1): II

	CAUTION
	<p>Danger of incorrect power supply voltage. Damage to the equipment.</p> <ul style="list-style-type: none"> ➤ Check the power supply voltage before connection and start-up. ➤ Compare the power supply voltage with the data indicated on the type plate.



See also electrical data (chap. 19.4).

	<p>To completely separate the chamber from the power supply, you must disconnect the power plug. Install the chamber in a way that the power plug is easily accessible and can be easily pulled in case of danger.</p>
---	--

4.2 Connection to a suction plant (optional)

When directly connecting a suction plant the spatial temperature exactitude, the heating-up and the recovering times and the maximum temperature will be negatively influenced. So no suction plant should be directly connected to the exhaust duct.

	<p>Active suction from the oven must only be performed together with extraneous air. Perforate the connecting piece to the suction device or place an exhaust funnel at some distance to the exhaust duct.</p>
---	--

	 CAUTION
	<p>The exhaust duct will become hot during operation.</p> <p>Danger of burning.</p> <p>∅ Do NOT touch the exhaust duct during operation.</p>

5. Start up

Having connected the electrical supply (chap. 4.1), turn on the chamber by the main power switch (1).

	<p>Warming chambers may release odors in the first few days after commissioning. This is not a quality defect. To reduce odors quickly we recommend heating up the chamber to its nominal temperature for one day and in a well-ventilated location.</p>
---	--

5.1 Air change

Opening the air flap in the exhaust duct serves to adjust the air change.

Without connecting a suction plant:

- If the air flap is open and the fan is operating, fresh air comes in via aeration gaps.
- If the air flap is completely open, the spatial temperature accuracy can be negatively influenced.

5.2 Settings at the RD3 program controller

After turning the chamber on with the main power switch (1) the controller is in Normal Display / fixed value operation mode.

Depending on the temperature value entered before LED (3a) is lit if the heating is active, or no LED if the actual temperature is equal to or above the set-point.

In **Display 1** of the controller the actual temperature value is displayed.

- With inactive week program timer:

In **Display 2** of the controller the actual date and time are displayed. Example:

15.05.06 13:52

- With active week program timer:

In **Display 2** of the controller the actual date and time and the states of the week program timer channels are displayed. Examples:

15.05.06 13:52 - -

Channel 1 Off,
Channel 2: Off

15.05.06 13:52 - □

Channel 1: Off,
Channel 2: On

15.05.06 13:52 □ -

Channel 1: On,
Channel 2: Off

15.05.06 13:52 □ □

Channel 1 On,
Channel 2: On

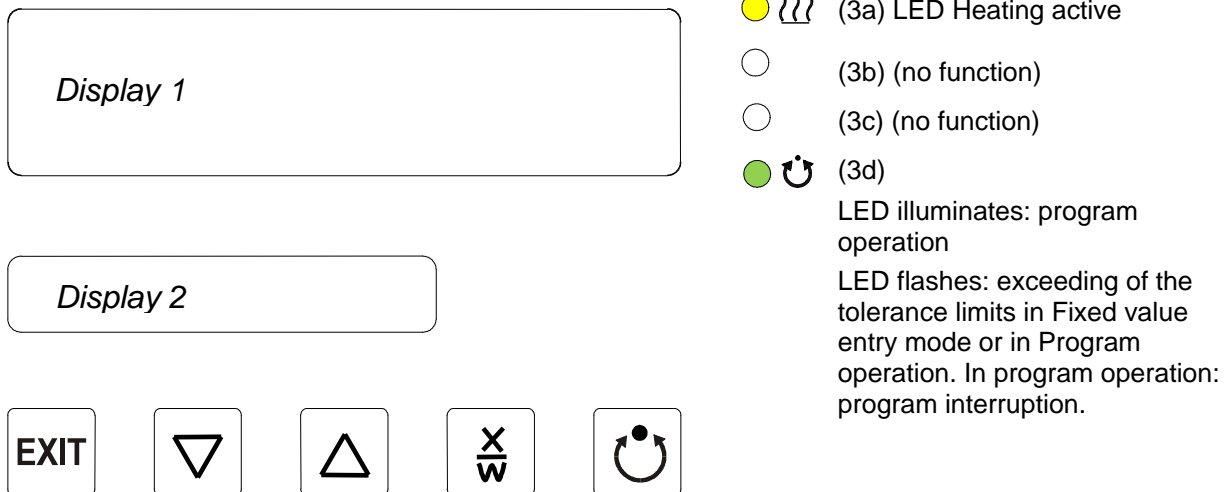



Figure 6: RD3 program controller

The program controller RD3 allows programming of temperature cycles. For each program section also the fan speed can be regulated.

Two programs with up to 10 sections each or one program with up to 20 sections can be entered (setting in the user level, chap. 10).

	When changing from 2 programs to 1 program or vice-versa, existing programs are deleted
---	---

The maximum length of an individual program section can be set to either 99 hs 59 min or to 999 hs 59 min (setting in the user level, chap. 10). This setting is then valid for all program sections.

Programming can be done directly via the controller keyboard or graphically at the computer using the software APT-COM™ 3 DataControlSystem (option, chap. 15.1) specially developed by BINDER.

5.3 General indications

The program controller RD3 offers several functional levels:

Normal Display / fixed value operation:

- Display of the actual value of temperature (display 1) and of the actual date and time (display 2).
- The chamber is in fixed value operating mode, adjusting to the entered set-points.

Fixed value entry mode (chap. 6)

- Entry of set-points for temperature and fan speed for fixed value operating mode
- Entry of set-points for temperature set-points 1 and 2 for week program operation

Program editor (chap. 8)

- Two programs with up to 10 sections each or one program with up to 20 sections can be entered (selection in the user level, chap. 10). Entry of set-points for temperature and fan speed in all program sections (chap. 8.2).
- Deleting a program section (chap. 8.4)

Program start level (chap. 9)

- Selection of an entered program
- Entry of settings affecting the program course, as start delay time or number of program cycles
- Program start

Week program editor (chap.7)

- Setting of the shift points

User level (chap. 10)

- User specific controller settings
- Setting the real time clock

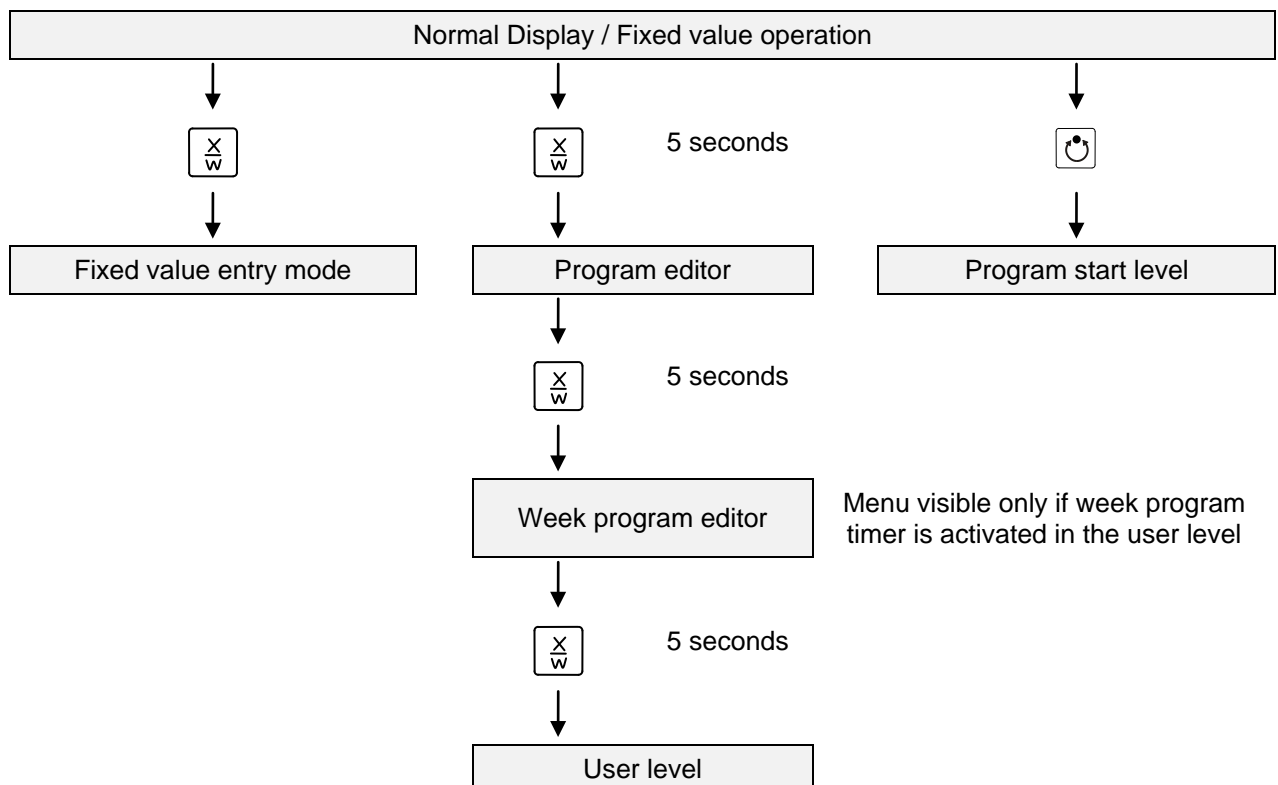

If no button is touched during more than 120 sec. the controller returns from the actual level to Normal Display.

6. Fixed value entry mode



If you do not want to use the week program timer, inactivate it (factory setting, setting in the user level, chap. 10) before entering set-points. Any setting of the operation lines in fixed value entry mode is ineffective with active week program timer.

Basic entry principle: Call up the individual parameters with button X/W one after the other. Enter the values with the arrow keys. A value flashing once after 2 seconds indicates that it has been taken over to the controller.

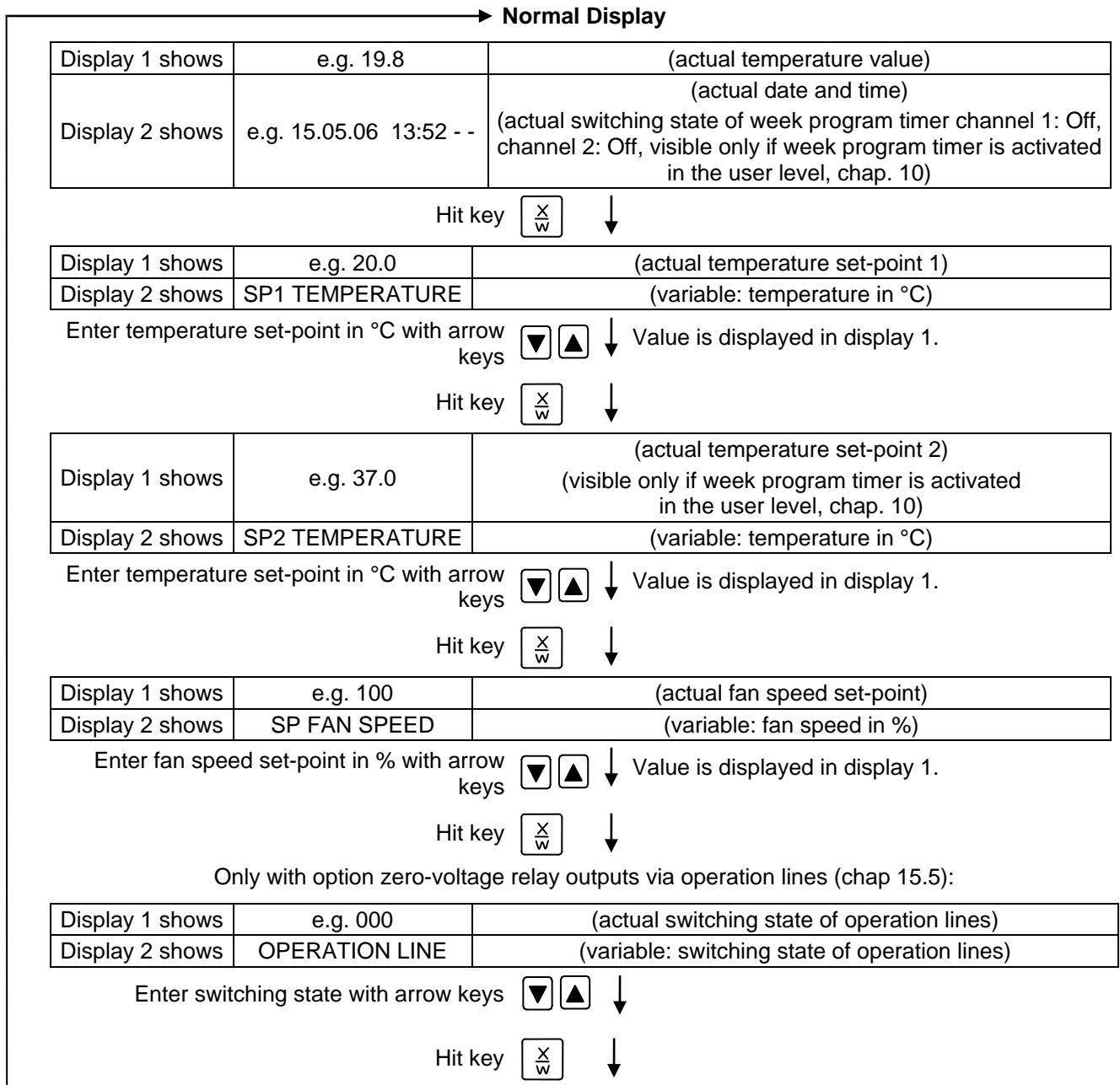

If no button is hit for more than 120 sec, or if the **EXIT** button is hit, the controller changes to Normal Display.



When changing the set-point, check the setting of the safety device (chap. 14.1).

 If the fan is operated with less than 100 % speed, the temperature performance and the spatial exactitude of the temperature can differ from the manufacturer's specifications. Do reduce the fan speed only if absolutely necessary due to special requirements.

 The values entered in fixed-value entry mode remain valid after program run-off and are then equilibrated.

If the week program timer is active, another set-point (SP2) might be targeted according to programming. Temperatures too high for the introduced solvent quantity can occur. Inactivate the week program timer if you do not use it (default setting, setting in the User level, chap. 10).

	CAUTION
	<p>Too high or too low temperature.</p> <p>Damage to the charging material.</p> <p>➤ Inactivate the week program timer if you do not use it.</p>

7. Week program editor

The Week program editor allows defining up to 4 shift point for each week day. A shift point defines a moment and the switching state ON or OFF of the channels getting active at this moment.

Channel function:

- Channel 1 On = Set-point 2 is equilibrated.
- Channel 1 Off = Set-point 1 is equilibrated
- Channel 2 = reserve

 The week program timer is first set to inactive (factory setting). Thus you need to activate the week program timer in the user level (chap. 10).

Normal Display

Display 1 shows	e.g. 19.8	(actual temperature value)
Display 2 shows	e.g. 15.05.06 13:52 - -	(actual date and time, actual state of week program timer channel 1: Off, channel 2: Off)

Press down key  ↓ for 5 sec



Display 1 shows	e.g. 0000	
Display 2 shows	PROGRAM EDITOR	(you are in the program editor)

Press down key  ↓ for 5 sec

Display 1 shows	0000	Menu visible only if week program timer is activated in the user level (chap. 10)
Display 2 shows	WEEK PROG. EDITOR	(you are in the week program editor)

Hit program key  ↓

Display 1 shows	0000	
Display 2 shows	UserCod? 0000	(enter user code, display flashes)

Enter the user code with arrow keys   ↓ e.g. **0001** (basic setting, adjustable in the user level, chap. 10).
Value is displayed in both displays.

Automatically forward after 2 sec

Display 1 shows	0000	
Display 2 shows	Monday	(selection of day of the week) (actual selection: Monday)

Select the day of the week (Monday up to Sunday) with key  ↓ Day of the week is displayed in display 2.

Hit program key  ↓

Display 1 shows	0000	
Display 2 shows	Shiftpt.	(no function)

Hit program key  ↓

Display 1 shows	0000	
Display 2 shows	Shiftpt. 1	(selection of the shift point) (actual shift point: 1)

Select the shift point (1 up to 4) with key  ↓ Value is displayed in display 2.

Hit program key  ↓

Display 1 shows	e.g. --:--	(time of the selected shift point)
Display 2 shows	S1: --:--	(actually selected shift point: S1) (actual setting: shift point not programmed)

Hit program key  ↓

Display 1 shows	--:--	(time of the selected shift point)
Display 2 shows	Time --:--	(entry of time of the selected shift point) (actual setting: shift point not programmed)

Enter the time (hh:mm) with arrow keys   ↓ Value is displayed in display 2.

Hit key  ↓

Display 1 shows	0000	
Display 2 shows	Ch1 = SP2: Off	(entry of state of channel 1) (actual setting: Off)

Enter the state of channel 1 (On or Off) with arrow keys   ↓ Setting is displayed in display 2.

Hit key  ↓

Display 1 shows	0000	
Display 2 shows	Channel 2: Off	(entry of state of channel 2) (no function) (actual setting: Off)

Enter the state of channel 2 (On or Off) with arrow keys   ↓ Setting is displayed in display 2.

Hit key  ↓

Hit key **EXIT** ↓

Display 1 shows	e.g., 08.30	(time of the selected shift point)
Display 2 shows	S1: 08:30 - -	(actually selected shift point: S1) (actual setting: time 08.30, channels Off)

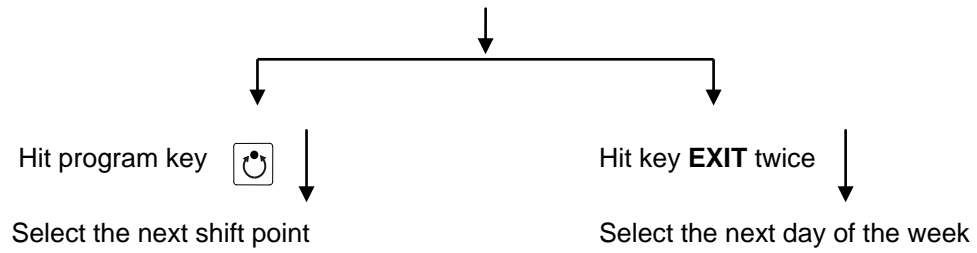

To exit the menu, hit several times key EXIT or wait for 120 seconds. Controller returns to normal display.

7.1 Program table template for Week program Editor

Program editor	
Program title	
Project	
Date:	

Day of the week	Time			Channel 1 (temperature)	Channel 2*
	hh:mm	AM	PM	ON (SP2) OFF (SP1)	ON OFF
Monday	S1				
	S2				
	S3				
	S4				
Tuesday	S1				
	S2				
	S3				
	S4				
Wednesday	S1				
	S2				
	S3				
	S4				
Thursday	S1				
	S2				
	S3				
	S4				
Friday	S1				
	S2				
	S3				
	S4				
Saturday	S1				
	S2				
	S3				
	S4				
Sunday	S1				
	S2				
	S3				
	S4				

* Channel 2 is without function at the standard chamber

8. Program editor

8.1 Selecting between set-point ramp and set-point step

You can program various kinds of temperature transitions. In the user level (chap. 10) you can select between the settings "Ramp" (default setting) and "Step".

	<p>Setting "Ramp" allows programming all kinds of temperature transitions. With setting "Step" the controller will equilibrate only to constant temperatures; programming ramps becomes impossible.</p>
---	---

	<p>A change between settings "Ramp" and "Step" will influence all programs. This can remarkably change the time courses of existing programs.</p>
---	---

8.1.1 Programming with setting "Ramp" (default setting)

Set-points always refer to the start of a program section, i.e., at the beginning of each program section, the entered set-point will be reached. During program section operation, the temperature gradually passes to the set-point entered for the following program section.

By appropriate design of the program section timing, all kinds of temperature transitions can be programmed:

- **Gradual temperature changes "set-point ramp"**

The set-point gradually moves from one set-point to the one of the following program section during a given interval. The actual temperature value (X) follows the continually moving set-point (W) at any moment.

- **Program sections with constant temperature**

The initial values of two subsequent program sections are identical; therefore the temperature is kept constant during the whole time of the first program section.

- **Sudden temperature changes "set-point step"**

Steps are temperature changes (ramps) that occur during a very short interval. Two program sections with an identical set-point are followed by a section with a different set-point. If the duration of this transitional program section is very short (minimum entry 1 min), the temperature change will proceed rapidly in the possible minimum time.

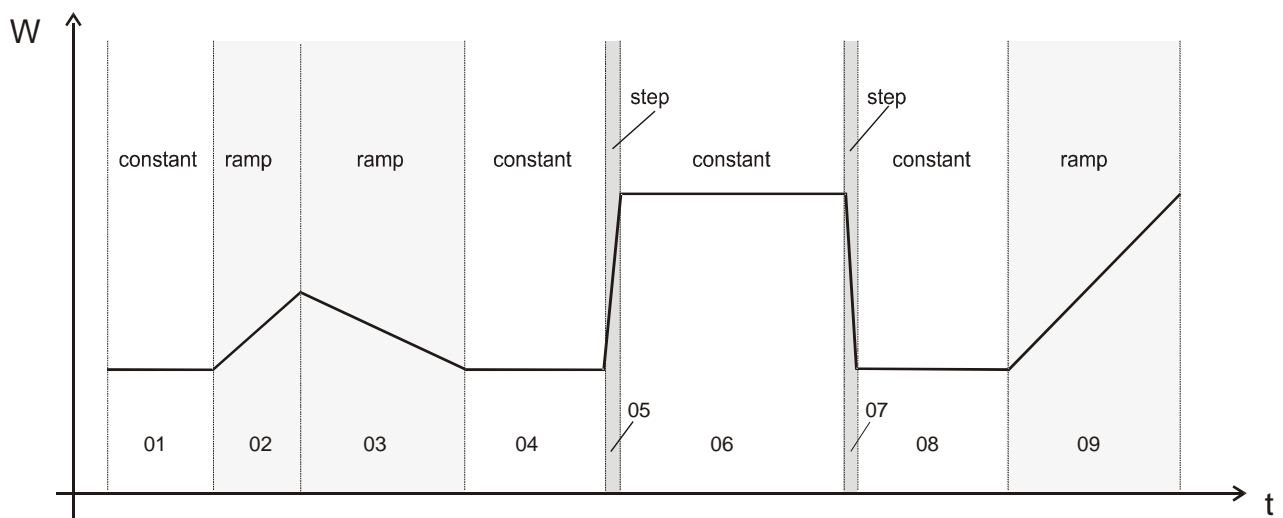
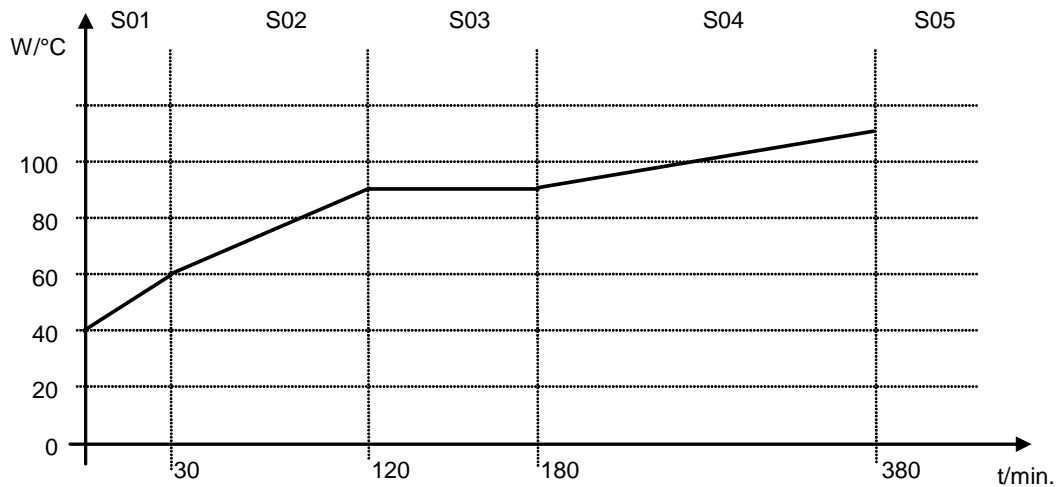

Figure 7: Possible temperature transitions
(with default setting "ramp" in the user level (chap. 10))

Program entry as set-point ramp (example):



Program table corresponding to the diagram (with default setting "Ramp"):

Section	Temperature set-point [°C]	Section length [hh.mm]	Fan speed [%]	Operation lines *
SEC	TEMP	TIME	FAN	O.LINE
S01	40	00:30	50	000
S02	60	01:30	100	000
S03	90	01:00	100	000
S04	90	03:20	100	000
S05	110	00:01	100	000

* Only with option zero-voltage relay outputs via operation lines, see chap 15.5.

The values of such a program table can now be entered to the RD3 program controller (chap. 8.2).

Program entry as set-point step (example):

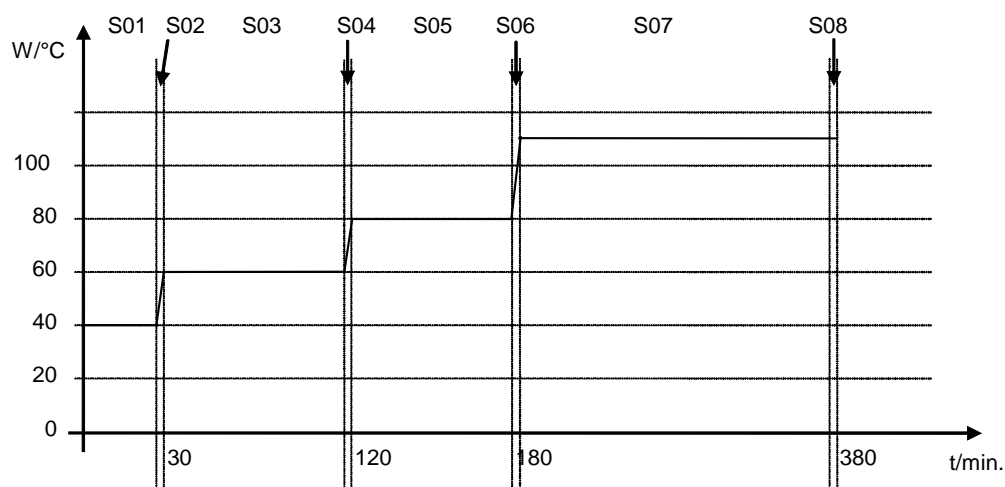

Program table corresponding to the diagram (with default setting "Ramp"):

Section	Temperature set-point [°C]	Section length [hh.mm]	Fan speed [%]	Operation lines *
SEC	TEMP	TIME	FAN	O.LINE
S01	40	00:30	50	000
S02	40	00:01	100	000
S03	60	01:30	100	000
S04	60	00:01	100	000
S05	80	01:00	100	000
S06	80	00:01	100	000
S07	110	03:20	100	000
S08	110	00:01	100	000

* Only with option zero-voltage relay outputs via operation lines, see chap 15.5.

The values of such a program table can now be entered to the RD3 program controller (chap. 8.2).

The end point of the desired cycle must be programmed with an additional section (in our examples S05 for set-point ramp and S08 for set-point step) with a section time of at least one minute. Otherwise the program will stop one section too early because the program line is incomplete.

8.1.2 Programming with setting "step"

With setting "Step" selected, you don't need to program the transition section in the Program Editor.



With setting "step" the controller will equilibrate only to constant temperatures; programming ramps becomes impossible.

The set-points are maintained constant for the duration of the program section. At the start of each program section, the chamber heats up in order to attain the entered set-point as fast as possible.

Program entry as set-point step (example):

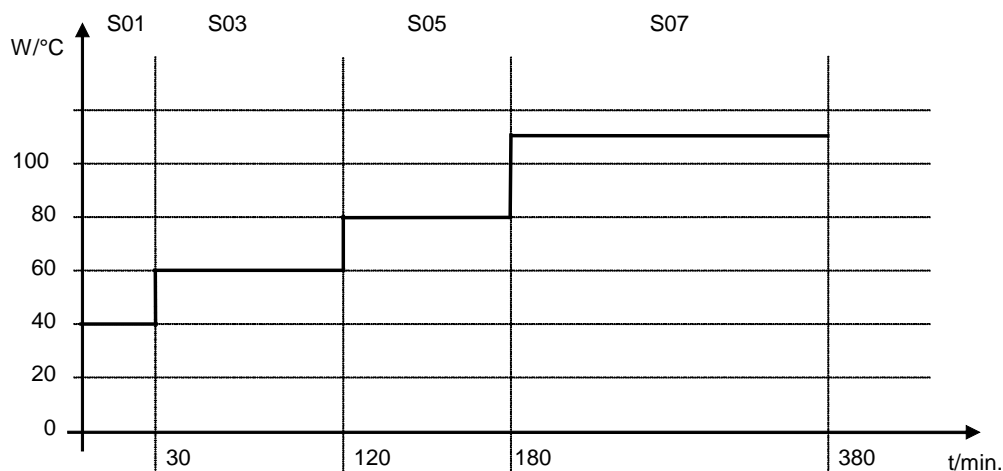

Program table corresponding to the diagram (with setting "Step"):

Section	Temperature set-point [°C]	Section length [hh.mm]	Fan speed [%]	Operation lines *
SEC	TEMP	TIME	FAN	O.LINE
S01	40	00:30	50	000
S02	60	01:30	100	000
S03	80	01:00	100	000
S04	110	03:20	100	000

* Only with option zero-voltage relay outputs via operation lines, see chap 15.5.

The values of such a program table can now be entered to the RD3 program controller (chap. 8.2).

8.1.3 General advice for the programming of temperature transitions

If the tolerance limits set in the user level (chap. 10) are exceeded, the program is halted until the actual temperature value is again situated in the tolerance range. During this program interruption the LED (3d) flashes. Therefore, the duration of the program might be extended due to the programming of tolerances

Programming is conserved even in case of power failure or after turning off the chamber.

After program rundown the controller returns to fixed value operation showing Normal Display and equilibrates to the temperature value previously entered in fixed value entry mode.



Before starting the program, check the set-point value entered in fixed value entry mode. After program rundown temperature will equilibrate to this value.



Inactivate the week program timer (factory setting, setting in the user level, chap. 10) before starting a program.

8.2 Set-point entry for program operation

From Normal Display the program editor is accessed by hitting button X/W for 5 sec. Here the set-points are entered one after the other in all program sections of a selected program.

Two programs with up to 10 sections each or one program with up to 20 sections can be entered (setting in the user level, chap. 10).

In order to avoid incorrect programming the values of the program course should be entered into a table (template in chap. 8.3).

Example of program table (with default setting "Ramp"):

Section	Temperature set-point [°C]	Section length [hh.mm]	Fan speed [%]	Operation lines *
SEC	TEMP	TIME	FAN	O.LINE
S01	40	00:30	50	000
S02	60	01:30	100	000
S03	90	01:00	100	000
S04	90	03:20	100	000
S05	110	00:01	100	000

* Only with option zero-voltage relay outputs via operation lines, see chap 15.5.

The values of the program table can now be entered to the RD3 program controller.

Step 1 – Selecting the program and the program section:

Normal Display



Display 1 shows	e.g. 19.8	(actual temperature value)
Display 2 shows	e.g. 15.05.06 13:52 - -	(actual date and time, actual state of week program timer channel 1: Off, channel 2: Off)

Press down key  ↓ for 5 sec.

Display 1 shows	e.g. 0000	
Display 2 shows	PROGRAM EDITOR	(you are in the program editor)

Hit program key  ↓

Display 1 shows	0000	
Display 2 shows	UserCod? 0000	(enter user code)

Enter user code with arrow keys   ↓ e.g. **0001**
(basic setting, adjustable in the user level, chap. 10).
Value is displayed in both displays.

Automatically forward after 2 sec.

Display 1 shows	e.g. 01	(program P01 selected)
Display 2 shows	--- : --- PRG.	(program can be selected)
alternating	CONTINUE X/W	(information: to 1 st program section with X/W)

Select program P01 or P02 with arrow keys   ↓ Value is displayed in display 1.



Hit key  ↓

In the selected program P01 or P02, program sections can be selected:

Display 1 shows	e.g. 01	(section S01 selected)
Display 2 shows	P01: --- SEC.	section S01 has already been created.
alternating	CONTINUE X/W	enter new set-points for the individual variables with button X/W

or:

Display 1 shows	e.g. 01	(section S01 selected)
Display 2 shows	P01: --- SEC.	section S01 has not yet been created.
alternating	NEW SEC. X/W	enter set-points for the individual variables with button X/W

Select sections S01 to S10 or to S20 with arrow keys   ↓

If no program section has been entered yet the display switches back to 01 with all entries > 01, because all sections have to be entered one after, and each new section is created as NEWSEC.

If e.g. already three program sections have been entered, the next section to be entered is S04. Before this, no section > S04 can be selected.







Next step – entry of set-points in the desired program sections:

Basic entry principle: The parameters of individual program sections are called up with button X/W one after the other. The values of the individual parameters can be entered with the arrow keys. A value flashes once after 2 seconds thus indicating that it has been taken over to the controller. If several parameters are to be skipped (e.g. in order to change a parameter in a posterior program section), the parameters can be rapidly jumped over by holding pressed down the X/W key. If no button is hit during more than 120 sec the controller switches back to Normal Display. The program entered so far remains saved.

Hit key  ↓

Display 1 shows	e.g. 40.0 ^C	(actual temperature set-point)
Display 2 shows alternating	S01: TEMP 40.0	(variable: temperature in °C)
	CONTINUE X/W	(information: go on with X/W)

Enter temperature set-point of S01 in °C with arrow keys   ↓

Hit key  ↓

Display 1 shows	e.g. 00.30	(actual section length set-point)
Display 2 shows alternating	S01: TIME 00:30	(variable: section length in hh:mm)
	CONTINUE X/W	(information: go on with X/W)

Enter section length set-point of S01 in hh.mm with arrow keys   ↓ Value is displayed in both displays.

Hit key  ↓



Display 1 shows	e.g. 50	(actual fan speed set-point)
Display 2 shows alternating	S01:FAN 50	(variable: fan speed in %)
	CONTINUE X/W	(information: go on with X/W)

Enter fan speed set-point of S01 in % with arrow keys   ↓ Value is displayed in both displays.

Hit key  ↓

Only with option zero-voltage relay outputs via operation lines (chap 15.5):

Display 1 shows	e.g. 000	(actually set switching state)
Display 2 shows alternating	S01:O.LINE 000	(variable: switching state)
	CONTINUE X/W	(Information: go on with X/W)

Enter switching state with arrow keys   ↓

Hit key  ↓





Selecting the next program sections to be entered



Display 1 shows	e.g. 02	(section S02 selected)
Display 2 shows alternating	P01: --- SEC. CONTINUE X/W	Section S02 has already been created. enter new set-points for the individual parameters with X/W.

or:

Display 1 shows	e.g. 02	(section S02 selected)
Display 2 shows alternating	P01: --- SEC. NEW SEC. X/W	Section S02 has not yet been created. enter set-points for the individual parameters with X/W

Select the next section to be entered with
arrow keys   ↓

Display 1 shows	e.g. 60.0 ^{°C}	(actual temperature set-point)
Display 2 shows alternating	S02:TEMP 60.0 CONTINUE X/W	(variable: temperature in °C) (information: go on with X/W)

Enter the temperature set-point of S02 in °C
with arrow keys   ↓

Etc.

If all sections up to S10 or up to S20 have been programmed follows again section S01. In order to quit the entry mode hit several times the EXIT button or wait 120 sec → the controller returns to Normal Display.



When changing the set-point, check the setting of the safety device (chap. 14.1).



If the fan is operated with less than 100 % speed, the temperature performance and the spatial exactitude of the temperature can differ from the manufacturer's specifications. The fan speed rate should only be reduced if absolutely necessary to meet special requirements.

8.3 Program table template

Program editor	
Program title	
Project	
Program No.	
Date:	

Section	Temperature set-point [°C]	Section length [hh.mm]	Fan speed [%]	Operation lines *
SEC	TEMP	TIME	FAN	O.LINE
S01				
S02				
S03				
S04				
S05				
S06				
S07				
S08				
S09				
S10				
S11				
S12				
S13				
S14				
S15				
S16				
S17				
S18				
S19				
S20				

* Only with option zero-voltage relay outputs via operation lines, see chap 15.5.



At the standard device the operation lines (O.LINE) are without any function.

8.4 Deleting a program section

A program section is deleted from the program by setting the section duration to Zero.



Normal display

Press down key  ↓ for 5 sec.

Display 1 shows	e.g. 0000	
Display 2 shows	PROGRAM EDITOR	(you are in the program editor)

Hit program key  ↓

Display 1 shows	0000	
Display 2 shows	UserCod? 0000	(enter user code)

Enter the user code with arrow keys   ↓ e.g. **0001**
 (basic setting, adjustable in the user level, chap. 10).
 Value is displayed in both displays.

Automatically forward after 2 sec

Display 1 shows	e.g. 01	(program P01 selected)
Display 2 shows	--- : --- PRG.	(program can be selected)
alternating	CONTINUE X/W	(information: to 1 st program section with X/W)

Select the desired program, e.g. P01, with arrow keys   ↓ Value is displayed in display1.

Hit key  ↓

In the selected program P01 or P02, program sections can be selected:

Display 1 shows	e.g. 01	(actual selected section: S01)
Display 2 shows	P01: --- SEC.	(program section can be selected)
alternating	CONTINUE X/W	(information: set-point entry with X/W)

Select desired section, e.g. S03, with arrow keys   ↓ (omitted if section S01 shall be deleted).



Hit key  ↓

Display 1 shows	e.g. 90.0 ^c	(actual temperature set-point)
Display 2 shows	S03:TEMP 90.0	(variable: temperature)
alternating	CONTINUE X/W	(information: go on with X/W)

No entry ↓

Hit key  ↓

Display 1 shows	e.g. 01.00	(actual section length)
Display 2 shows	S03:TIME 01:00	(variable: section length)
alternating	CONTINUE X/W	(information: go on with X/W)

Enter set-point **Zero** for section length in hh:mm of S03 with arrow keys   ↓ Value is displayed in display 2 or in both displays
 (display depends on maximum time setting in the user level chap. 10)

Display 1 shows	e.g. 00.00	(actual section length)
Display 2 shows	S03:TIME 00:00	(variable: section length)
alternating	DELETE SEC. X/W	(information: delete section with X/W)

Hit key  ↓

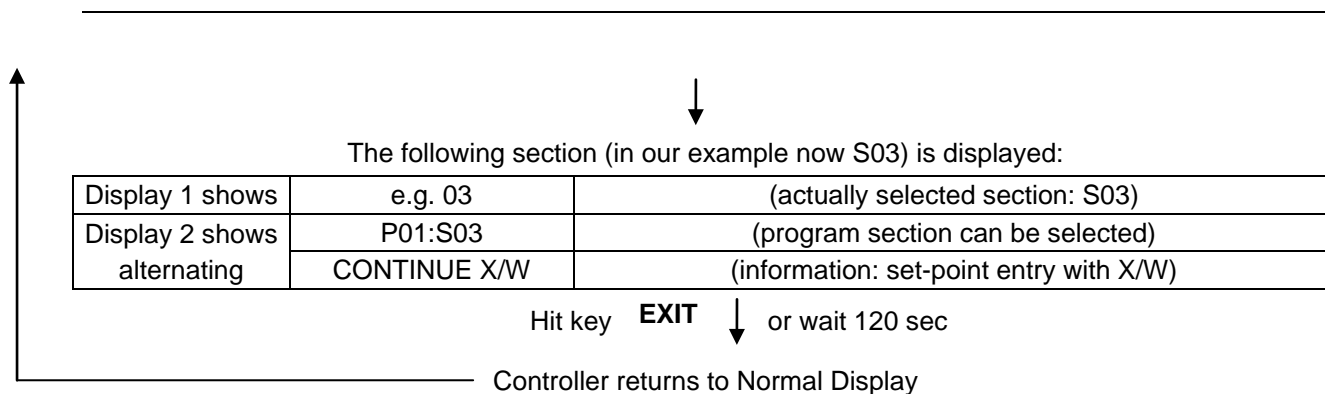

	If you delete a program section which is followed by further sections, those following move up to the place of the deleted section.
---	---

In our example section S03 has been deleted. Sections S04, S05, etc., in case they have been programmed earlier, will now receive the preceding sections numbers, i.e., S04 is now called S03 etc.

It is thus not possible to temporarily inactivate a program section, but deletion leads to overwriting the section by the following one. To enter a section later to a program also the sections following the new one must be entered again.

9. Program start level

Before starting the program, check the set-point entered in Fixed value operation mode. After end of the program, the temperature will equilibrate to this value. This value must not exceed the permitted drying temperature for the used solvent quantity.

	CAUTION
	<p>Too high or too low temperature after end of program.</p> <p>Damage to the charging material.</p> <p>➤ Check the set-point of Fixed value operation and if necessary adapt it.</p>

After end of the program, the temperature will equilibrate to the set-point entered in Fixed value operation mode. If the week program timer is active, another set-point (SP2) might be targeted according to programming. Inactivate the week program timer before starting the program (default setting, setting in the User level, chap. 10).

	CAUTION
	<p>Too high or too low temperature after end of program.</p> <p>Damage to the charging material.</p> <p>➤ Inactivate the week program timer before starting the program.</p>

In a first step a program is selected. This on condition that a program has been entered previously (chap. 8.2) and that program type "2 programs with 10 sections each" has been selected in the user level (chap. 10).

Then the settings for the program course are defined. Two parameters can be set:

- Program delay time, i.e. a defined time before program start. It can be entered with precision of 1 min and is max. 99.59 (99 hs 59 min). If the value is 00.00 the program is started without any delay.
- Number of program cycles, i.e. the desired number of program repeats. Values from 1 to 99 can be entered. If the program is not to be repeated, enter value 0. For infinite repeats enter value -1. The program is repeated as a whole, it is not possible to repeat individual sections.

In a last step the selected program is started. These steps must be carried out subsequently.



Inactivate the week program timer (factory setting, setting in the user level, chap. 10) before starting a program.

Step 1 – Program selection (only with program type “2 programs” set):

Normal Display

Hit program key  ↓

Display 1 shows	e.g. 1	(actually selected program)
Display 2 shows	SEL.PRG.	(select program 1 or 2)

Enter program number 1 or 2 with arrow keys   ↓ Value is displayed in display 1.

Next step – entry of program course settings

Hit program key  ↓

Display 1 shows	e.g. 00.00	(entered delay time hh.mm)
Display 2 shows	RUN TIME	(enter delay time of program start)

Set delay time in hh.mm with arrow keys   ↓ Value is displayed in display 1.

Hit program key  ↓

Display 1 shows	e.g. -1	(actually selected number of program cycles)
Display 2 shows	REPEAT	(enter number of program cycles)

Select number of cycles -1, 0, 1 etc. with arrow keys   ↓ Value is displayed in display 1.

Last step – program start:

Hit program key  ↓

Display 1 shows	e.g. 1	(selected program)
Display 2 shows	RUN PRG.	(Question: start selected program?)

Hit program key  ↓

Display 1 shows	e.g. 25.5 ^C	actual temperature value
Display 2 shows	P01:S01 00:29:39 (time running backwards)	(actual program P01, actual section S01, and remaining time of program section S01)

Program is running. The green LED (3d) lights up.

Additionally to the green LED (3d) indicating a running program LED (3a) is lit if the heating is active, or no LED if the actual temperature equals the set-point.



During program course the arrow keys and the EXIT button are not functional.



By hitting the program key  for 3 seconds, you can terminate the program course.

If during program course button  is hit, the entered set-points of the actually running program section are shown one after the other for 5 sec. each:

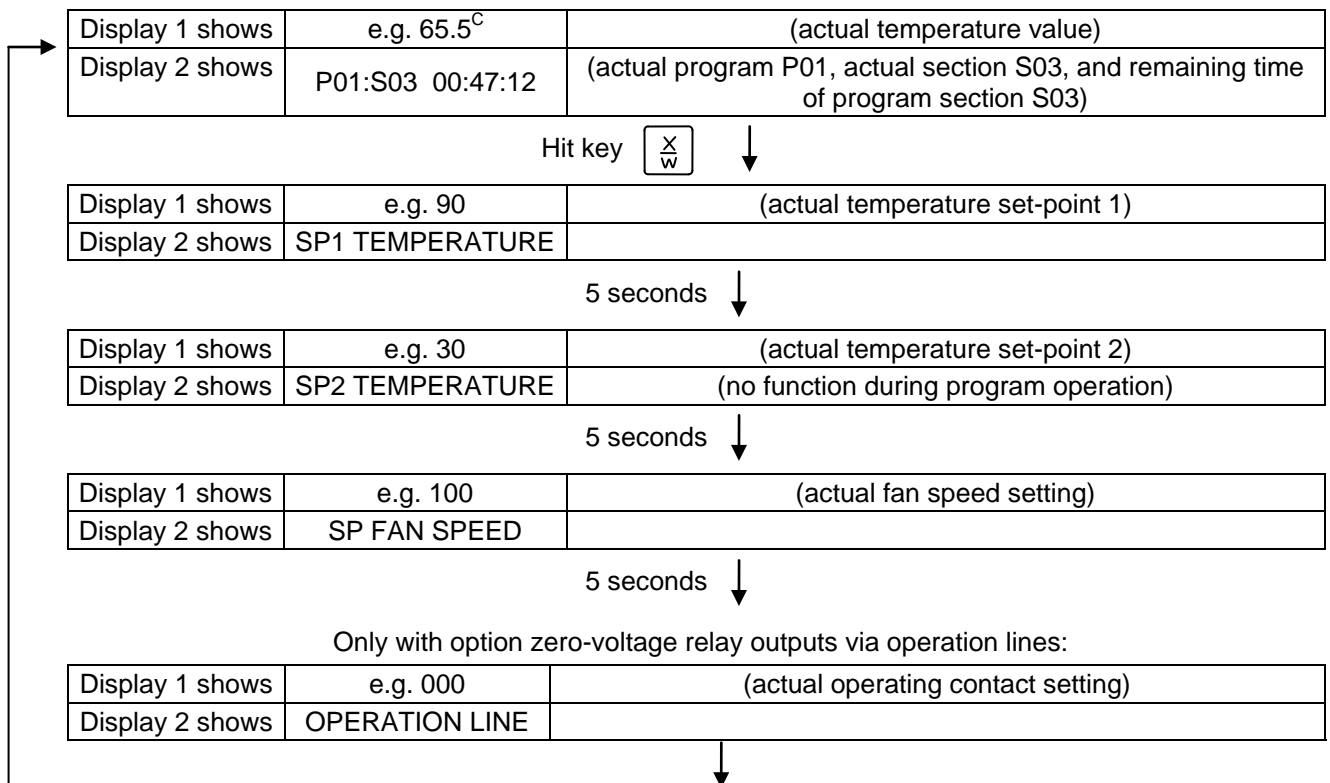

After program runoff (and, if appropriate, of the program repeats) the controller returns to fixed value operation showing Normal Display and adjusting to the temperature and fan speed values that have been previously entered in the fixed value entry mode.

10. User level

In this menu the following parameters can be set (in brackets the corresponding abbreviated information given in display 2):

- **Chamber address** (Address)
Setting of controller address (1 to 255) for operation with the communication software APT-COM™.
- **User code** (User-cod)
Modification of the user code setting (factory setting 0001) for access to the user level and the program editor.



Keep in mind any modification of the user code. There is no access to these levels without a valid user code.

- **Decimal point position** (Decimal)
Selection if integer values or one position after the decimal point can be entered. The integer representation is displayed in Display 2 (set-point entry) while the actual value in Display 1 is always displayed with one decimal point.
- **Buzzer** (Buzzer)
Inactive: no audible signal (buzzer) in case of an alarm event.
Active: in case of an alarm event (see chap. 13.2) an audible signal (buzzer) will run. It can be reset by hitting button EXIT.

- **Selection of controller menu language** (Language)
German, English, or French can be selected.
- **Counter of operating hours** (Oper.hs)
 Information about the number of operating hours reached up to now or since the last reset. (no setting, display only).
- **Max. number of operating hours** (Op.limit)
 Entry of a limit number of operating hours, i.e., the maximal number of operating hours that can be run. Maximum setting: 9999. Reaching the limit has no effect.
- **Reset operating hours** (Op.back)
 Reset operating hours to zero.
- **Interface protocol** (Protocol)

“**Modbus**”: The chamber interface can be used as a communication interface to connect it to a computer. This serves to control the chamber by the communication software APT-COM™. It is possible to read and write the values of all parameters.

“**Printer**”: A protocol printer for data printouts can be connected to the chamber interface. The printer regularly protocols the actual temperature value with fixed formatting and with adjustable print intervals.

In both cases an interface converter RS 422 / RS 232 is used.
- **Print interval** (Prt.-Inv.)
 Setting of the print interval in minutes. Function available only if setting “Printer” has been selected in the previous menu point.
- **Display illumination** (Disp.LED)
 Selection between continuous display illumination and limited illumination that will automatically go off 300 sec after the last entry.
- **Program type selection** (PrgSelec)
 Select between entry of two programs with up to 10 sections each or of one program with up to 20 sections.

	When changing from 2 programs to 1 program or vice-versa, existing programs are deleted in the program editor.
---	--
- **Maximum section duration** (Prg.Time)
 The maximum length of an individual program section can be set to either 99 hs 59 min or to 999 hs 59 min. This setting is then valid for all program sections.

	When changing the maximum duration setting, pre-existing programs will be deleted in the program editor.
---	--
- **Set-point programming type** (Setp.sim)
 Selection between “Ramp” and “Step”. With setting „Step“ selected, you don’t need to program the transition section in the Program Editor.

	If you select setting “step”, the controller will equilibrate only to constant temperatures; programming ramps becomes impossible.
---	--

	A change between settings “ramp” and “step” will influence all programs. This can remarkably change the time courses of existing programs.
---	--

- **Tolerance limit range** (Tol.band)

Entry of a tolerance limit value in °C. If the actual value of temperature exceeds the set-point of a program section by more than the entered tolerance limit value, the program is halted (LED (3d) flashing) until the actual temperature value is again situated within the tolerance range.

Entry of "0" means tolerance limits off.

- **Activating or inactivating the week program timer** (Prog.Clk)

„Inactive“: The week program timer is turned off (factory setting). The according setting menu (chap. 7) is not visible, as is set-point 2 in fixed value entry mode (chap. 6).

„Active“: The week program timer is activated.

	When inactivating the week program timer, any programming remains in the memory and will be effective again when the week program timer is activated again.
---	---

	Inactivate the week program timer before entering set-points in fixed value entry mode (chap. 6). Otherwise, any setting of the operation lines is ineffective.
---	---

	Inactivate the week program timer before starting a program (chap. 9).
---	--

- **Display mode** (12h/24h)

Select between 12 hours (display "AM" or "PM") or 24 hours.

- **Date of the real time clock** (Date)

Main menu. Use the program key to access the settings of year, month, and day in the according submenus.

- **Year of the real time clock** (Year)

Enter the year (2006 up to 2050)

- **Month of the real time clock** (Month)

Enter the month (1 up to 12).

- **Day of the real time clock** (Day)

Enter the day (1 up to 31).

- **Time of the real time clock** (Time)

Main menu. Use the program key to access the settings of hour and minute in the according submenus.

	There is no automatic switch between summer time and regular time.
---	--

- **Hour of the real time clock** (Hour)

Enter the hour (0 up to 23).

- **Minute of the real time clock** (Minute)

Enter the minute (0 up to 59).

Normal Display

Display 1 shows	e.g. 19.8	(actual temperature value)
Display 2 shows	e.g. 15.05.06 13:52 --	(actual date and time, actual switching state of week program timer channel 1: Off, channel 2: Off)

Press down key  ↓ for 5 sec

Display 1 shows	e.g. 0000	
Display 2 shows	PROGRAM EDITOR	(you are in the program editor)

Press down key  ↓ for 5 sec



Display 1 shows	0000	Menu visible only if week program timer is activated.
Display 2 shows	WEEK PROG. EDITOR	(you are in the week program editor)

Press down key  ↓ for 5 sec

Display 1 shows	0000	
Display 2 shows	USER – LEVEL	(you are in the user level)

Hit program key  ↓

Display 1 shows	0000	
Display 2 shows	UserCod? 0000	(enter user code, display flashes)

Enter the user code with arrow keys   ↓ e.g. **0001** (basic setting, or the valid code in case it has been previously changed in this menu). Value is displayed in both displays.

Automatically forward after 2 sec

Display 1 shows	1	(actual address: 1)
Display 2 shows	Adress 1	(entry of chamber address) (actual address: 1)

Enter the chamber address (1 up to 254) with arrow keys   ↓ Address is displayed in both displays.

Hit key  ↓

Display 1 shows	1	(actually valid user code: 1)
Display 2 shows	User-cod 1	(change user code) (actually set: 1)

Enter a new value with arrow keys   ↓ Value is displayed in both displays.

Hit key  ↓

Display 1 shows	0000	(no function)
Display 2 shows	Saf.mode: Limit	(no function)

Hit key  ↓

Display 1 shows	0	(no function)
Display 2 shows	Saf.setp 0	(no function)

Hit key  ↓

Display 1 shows	0000	(no function)
Display 2 shows	Decimal: XXX.X	(setting of decimal point position) (actual setting: XXX.X)

Select decimal point position with arrow keys   ↓ Decimal point position XXX.X or XXXX. is displayed in display 2.

Hit key  ↓

Display 1 shows	0000	(no function)
Display 2 shows	Buzzer : Active	(setting of the alarm buzzer) (actual setting: „Active“)

Select between “Active” and “Inactiv” with arrow keys   ↓ Setting is displayed in display 2.

Hit key  ↓

Display 1 shows	0000	(no function)
Display 2 shows	Language : English	(selection of controller language) (actual setting: English)

Select between languages German, English, and French with arrow keys   ↓ Setting is displayed in display 2.

Hit key  ↓

Display 1 shows	e.g. 0004	(chamber operating hours)
Display 2 shows	Oper.hs 0004:28	(operating hours up to now hhhh:mm) (actually displayed: 4 hs 28 min)

Hit key  ↓

Display 1 shows	1000	(actual setting: 1000 hs)
Display 2 shows	Op.limit 1000:00	(maximum number of operating hours hhhh:mm (actual setting: 1000 hs)

Set value with arrow keys   ↓ Setting is displayed in both displays.

Hit key  ↓

Display 1 shows	0000	(no function)
Display 2 shows	Op.back : No	(reset counter of operating hours ?) (actual setting: No)

Select between “Yes” and “No” with arrow keys   ↓ Setting is displayed in display 2.

Hit key  ↓

Display 1 shows	0000	(no function)
Display 2 shows	Protocol: MODBUS	(Selection of interface mode) (actual setting: Modbus)

Select between protocols “MODBUS” and “Printer” with arrow keys   ↓ Setting is displayed in display 2.

Hit key  ↓

Display 1 shows	e.g. 3	(actual setting: 3 min)
Display 2 shows	Prt-Inv. 3	(print interval) (actual setting: 3 min)

Select value between 0 and 255 minutes with arrow keys   ↓ Setting is displayed in displays 1 and 2.

Hit key  ↓

Display 1 shows	0000	
Display 2 shows	Disp.LED: No	(continuous display illumination?) (actual setting: No)

Select between "Yes" and "No" with arrow keys   ↓ Setting is displayed in display 2.

Hit key  ↓

Display 1 shows	0000	
Display 2 shows	PrgSelec: 2Prg10S	(1 program with max. 20 sections or 2 programs with max. 10 sections each?) (actual setting: 2Prg10S)

Select between "2Prg10S" and "1Prg20S" with arrow keys   ↓ Setting is displayed in display 2.

Hit key  ↓

Display 1 shows	0000	
Display 2 shows	Prg.Time: 99:59	(max. section length 99:59 or 999:59?) (actual setting: 99:59)

Select between 99:59 in hh:mm or 999:59 in hhh:mm with arrow keys   ↓ Setting is displayed in display 2.

Hit key  ↓

Display 1 shows	0000	
Display 2 shows	Setp.sim Ramp	(ramp or step?) (actual setting: ramp)

Select between Ramp and Step with arrow keys   ↓ Setting is displayed in display 2.

Hit key  ↓

Display 1 shows	0000	
Display 2 shows	Tol.band 0	(Tolerance limits in °C) (actual setting: 0)

Set value in °C with arrow keys   ↓ Setting is displayed in display 2.

Hit key  ↓

Display 1 shows	0000	
Display 2 shows	Prog.Clk Inactive	(Week program timer active or inactive?) (actual setting: Inactive)

Select between "Active" and "Inactive" with arrow keys   ↓ Setting is displayed in display 2.

Hit key  ↓

Display 1 shows	0000	
Display 2 shows	12h/24h 24h	(Display mode 12 hours or 24 hours?) (actual setting: 24h)

Select between 12 hours and 24 hours with arrow keys   ↓ Setting is displayed in display 2.

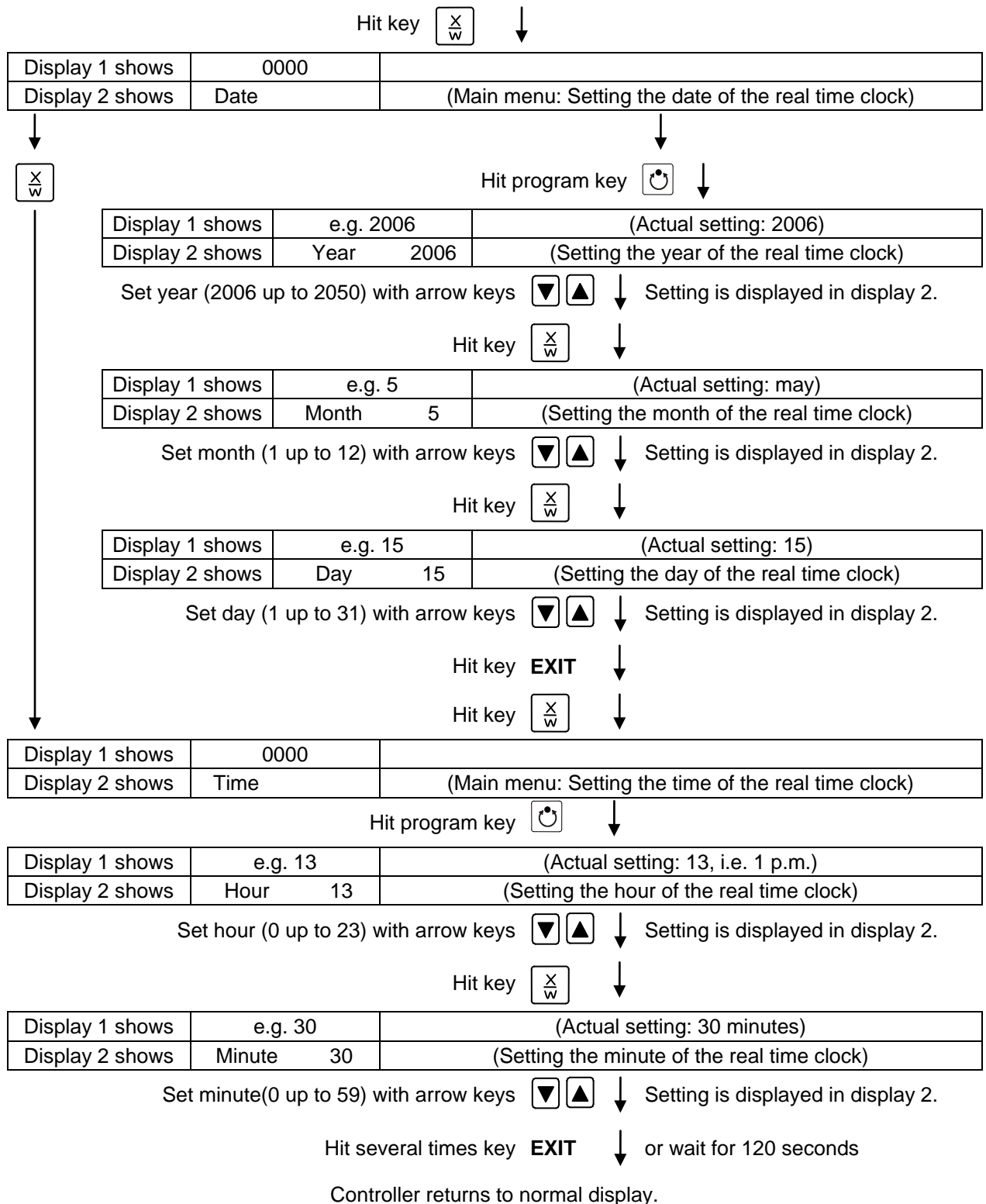

11. Example programming for the Week Program Editor

11.1 Desired time function

From Monday to Friday the chamber shall maintain a temperature of +60 °C, and during the week-end (Saturday and Sunday) a temperature of +30 °C.

This program shall automatically run during the whole year, i.e. it shall be programmed just once.

11.2 Proceeding overview

1. Settings in the user level (see chap. 10)

- Activating the week program timer
- Checking and, if necessary, setting the real time clock

2. Enter the set-points for the week program in Fixed value entry mode (see chap. 6)

Set-points for the example program:

SP 1 (night / weekend) = 30 °C

SP 2 (day / week) = 60 °C

3. Enter the time program to the week program editor (see chap. 7)

Program table for the example program:

Day of the week	Time			Channel 1 (temperature) ON (SP2) OFF (SP1)
	hh:mm	AM	PM	
Monday	S1 06:00			ON
Friday	S1 20:00			OFF



Make sure that no other shift points have been programmed due to previous programming. If so, they must be deleted: Set the time of the respective shift point to “ --:-- ” with key .

11.3 Proceeding in detail

1. Settings in the user level:

- Activating the week program timer
- Checking and, if necessary, setting the real time clock

Normal Display

Display 1 shows	e.g. 19.8	(actual temperature value)
Display 2 shows	e.g. 15.05.06 13:52 - -	(actual date and time, actual switching state of week program timer channel 1: Off, channel 2: Off)

Press down key  ↓ for 5 sec

Display 1 shows	e.g. 0000	
Display 2 shows	PROGRAM EDITOR	(you are in the program editor)

Press down key  ↓ for 5 sec



Display 1 shows	0000	Menu visible only if week program timer is activated.
Display 2 shows	WEEK PROG. EDITOR	(you are in the week program editor)

Press down key  ↓ for 5 sec

Display 1 shows	0000	
Display 2 shows	USER – LEVEL	(you are in the user level)

Hit program key  ↓

Display 1 shows	0000	
Display 2 shows	UserCod? 0000	(enter user code, display flashes)

Enter the user code with arrow keys   ↓ e.g. **0001** (basic setting, or the valid code in case it has been previously changed in this menu). Value is displayed in both displays.

Automatically forward after 2 sec

Display 1 shows	1	(actual address)
Display 2 shows	Address 1	(entry of chamber address) (actual address: 1)

Hit several times key  ↓ until **Prog.Clk** appears:

Display 1 shows	0000	
Display 2 shows	Prog.Clk Active	(Week program timer active or inactive?) (actual setting: Active)

Select "**Active**" with arrow keys   ↓ Setting is displayed in display 2.

Hit key  ↓



Display 1 shows	0000	
Display 2 shows	12h/24h 24h	(Display mode 12 hours or 24 hours?) (actual setting: 24h)

Hit key  ↓

Display 1 shows	0000	
Display 2 shows	Date	(Main menu: Setting the date of the real time clock)

Hit program key  ↓

Display 1 shows	e.g. 2006	(Actual setting: 2006)
Display 2 shows	Year 2006	(Setting the year of the real time clock)

Set **year** (2006 up to 2050) with arrow keys   ↓ Setting is displayed in display 2.

Hit key  ↓

Display 1 shows	e.g. 5	(Actual setting: may)
Display 2 shows	Month 5	(Setting the month of the real time clock)

Set **month** (1 up to 12) with arrow keys   ↓ Setting is displayed in display 2.

Hit key  ↓

Display 1 shows	e.g. 15	(Actual setting: 15)
Display 2 shows	Day 15	(Setting the day of the real time clock)

Set **day** (1 up to 31) with arrow keys   ↓ Setting is displayed in display 2.

Hit key **EXIT** ↓

Hit key  ↓

Display 1 shows	0000	
Display 2 shows	Time	(Main menu: Setting the time of the real time clock)

Hit program key  ↓

Display 1 shows	e.g. 13	(Actual setting: 13, i.e. 1 p.m.)
Display 2 shows	Hour 13	(Setting the hour of the real time clock)

Set **hour** (0 up to 23) with arrow keys   ↓ Setting is displayed in display 2.

Hit key  ↓

Display 1 shows	e.g. 30	(Actual setting: 30 minutes)
Display 2 shows	Minute 30	(Setting the minute of the real time clock)

Set **minute** (0 up to 59) with arrow keys   ↓ Setting is displayed in display 2.

Hit several times key **EXIT** ↓ or wait for 120 seconds

Controller returns to normal display.

2. Enter the set-points for the week program in Fixed value entry mode (see chap. 6)

Set-points for the example program:

SP 1 (night / weekend) = 30 °C

SP 2 (day / week) = 60 °C

Normal Display

Display 1 shows	e.g. 19.8	(actual temperature value)
Display 2 shows	e.g. 15.05.06 13:52 - -	(actual date and time, actual switching state of week program timer channel 1: Off, channel 2: Off)

Hit key  ↓

Display 1 shows	30.0	(actual temperature set-point 1)
Display 2 shows	SP1 TEMPERATURE	(variable: temperature in °C)

Enter temperature set-point **30 °C** with arrow keys   ↓ Value is displayed in display 1.

Hit key  ↓

Display 1 shows	60.0	(actual temperature set-point 2)
Display 2 shows	SP2 TEMPERATURE	(variable: temperature in °C)

Enter temperature set-point **60 °C** with arrow keys   ↓ Value is displayed in display 1.

Hit the EXIT button. The controller changes to Normal Display.

3. Enter the time program to the week program editor

Program table for the example program:

Day of the week	Time			Channel 1 (temperature) ON (SP2) OFF (SP1)
	hh:mm	AM	PM	
Monday	S1	06:00		ON
Friday	S1	20:00		OFF

SP 1 (night / weekend) = 30 °C, SP 2 (day / week) 60 °C



Make sure that no other shift points have been programmed due to previous programming. If so, they must be deleted: Set the time of the respective shift point to “ --:-- ” with key .

Normal Display

Display 1 shows	e.g. 19.8	(actual temperature value)
Display 2 shows	e.g. 15.05.06 13:52 - -	(actual date and time, actual state of week program timer channel 1: Off, channel 2: Off)

Press down key  ↓ for 5 sec



Display 1 shows	e.g. 0000	
Display 2 shows	PROGRAM EDITOR	(you are in the program editor)

Press down key  ↓ for 5 sec

Display 1 shows	0000	
Display 2 shows	WEEK PROG. EDITOR	(you are in the week program editor)

Hit program key  ↓

Display 1 shows	0000	
Display 2 shows	UserCod? 0000	(enter user code, display flashes)

Enter the user code with arrow keys   ↓ e.g. **0001** (basic setting, adjustable in the user level, chap. 10).
Value is displayed in both displays.

Automatically forward after 2 sec

Display 1 shows	0000	
Display 2 shows	Monday	(selection of day of the week) (actual selection: Monday)

Select the first day of the week (**Monday**) with key  ↓ Day of the week is displayed in display 2.

Hit program key  ↓

Display 1 shows	0000	
Display 2 shows	Shiftpt.	(no function)

Hit program key  ↓

Display 1 shows	0000	
Display 2 shows	Shiftpt. 1	(selection of the shift point) (actual shift point: 1)

Select shift point 1 with key  ↓ Value is displayed in display 2.

Hit program key  ↓

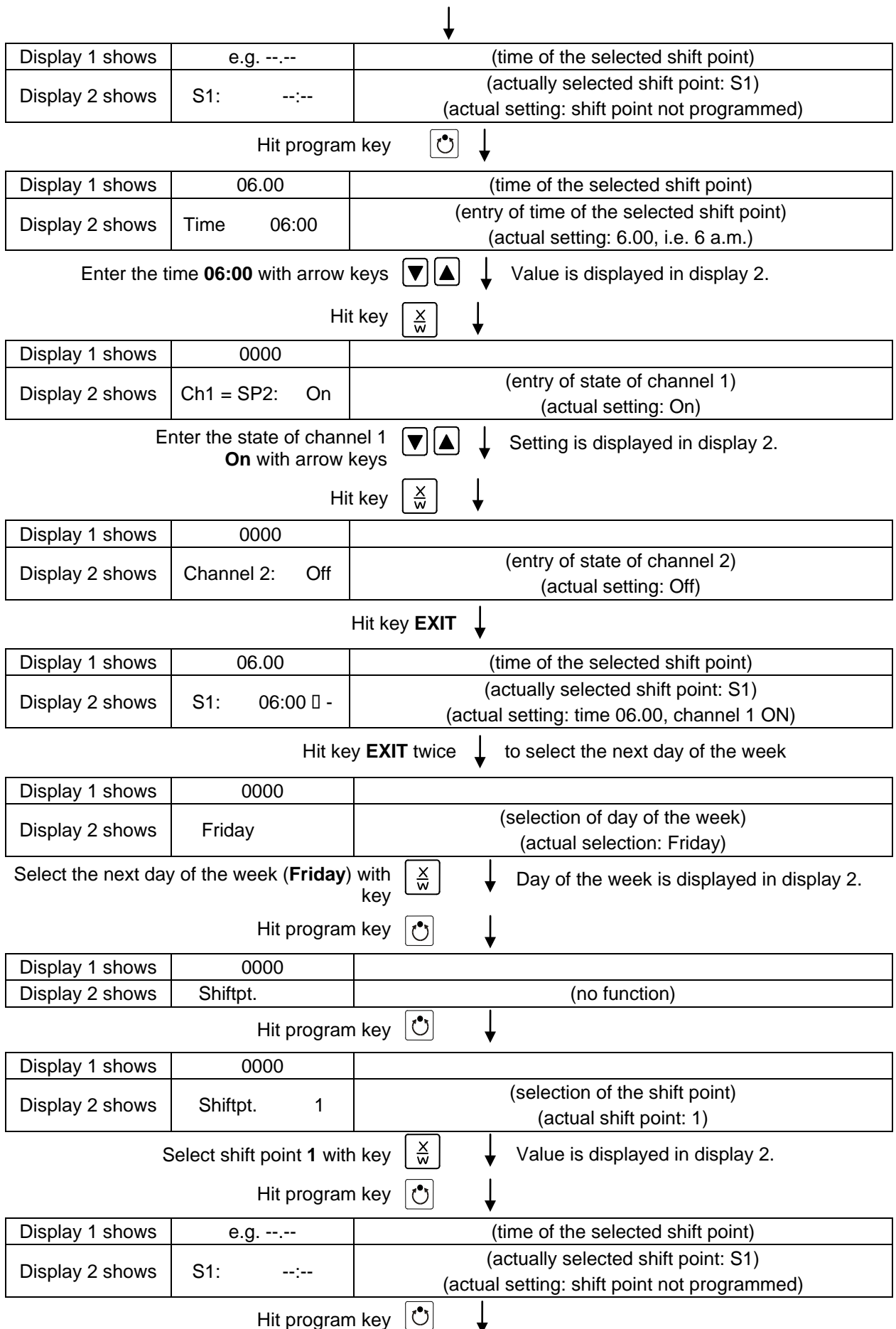



Display 1 shows	20.00	(time of the selected shift point)
Display 2 shows	Time 20:00	(entry of time of the selected shift point) (actual setting: 20.00, i.e. 8 p.m.)

Enter the time **20:00** with arrow keys   ↓ Value is displayed in display 2.

Hit key  ↓

Display 1 shows	0000	
Display 2 shows	Ch1 = SP2: Off	(entry of state of channel 1) (actual setting: OFF)

Enter the state of channel 1 **Off** with arrow keys   ↓ Setting is displayed in display 2.

Hit key  ↓

Display 1 shows	0000	
Display 2 shows	Channel 2: Off	(entry of state of channel 2) (actual setting: Off)

Hit key **EXIT** ↓

Display 1 shows	20.00	(time of the selected shift point)
Display 2 shows	S1: 20:00 - -	(actually selected shift point: S1) (actual setting: time 20.00, channels OFF)

Hit several times key **EXIT** ↓ or wait for 120 seconds

Controller returns to normal display.

12. Example programming for the Program editor

12.1 Desired time function

From Monday to Friday the chamber shall maintain a temperature of +60 °C, and during the week-end (Saturday and Sunday) a temperature of +30 °C.

This program shall automatically run during the whole year, i.e. it shall be programmed just once.

12.2 Proceeding overview

1. Settings in the user level (see chap. 10)

- **Set maximum section duration (Prg. Time) to 999 hs. 59 min.**

The maximum length of a program section can be set – in common for all program sections – to 99 hs 59 min or to 999 hs 59 min. Select setting 999:59.



When changing the maximum duration setting, pre-existing programs will be deleted in the program editor.

- **Turning off the tolerance limits function**

Select setting “0” meaning tolerance limits off. Thus an interruption of the program course during the heating-up or cooling-down phases during the rapid “set-point step” phase is avoided.

- **Inactivating the week program timer**

Inactivate the week program timer before entering a program (factory setting). Otherwise, any setting of the operation lines in the program editor is ineffective.

2. Enter the time program to the program editor

Program table for the example program:

Section	Temperature set-point [°C] TEMP	Section length [hh.mm] TIME	Fan speed [%] FAN	Operation lines O.LINE
S01	60	119:59	100	000
S02	60	000:01	100	000
S03	30	047:59	100	000
S04	30	000:01	100	000



Make sure that there are no more program sections (S05 etc.) existing due to previous programming. If so, they must be deleted (see chap. 8.4)

3. Set the number of cycles to infinite in the program start level and start the program



The described example program must be started once at the precise moment of temperature change (on Monday e.g., at 0.01 or at 7.00). If the program cannot be manually started at the desired moment, you can program a suitable program delay-time of 99 hs. 59 min. max. After rundown of this delay time the program starts automatically (chap. 9).

12.3 Proceeding in detail

1. Settings in the user level:

- **Set maximum section duration (Prg. Time) to 999 hs. 59 min.**

The maximum length of a program section can be set – in common for all program sections – to 99 hs 59 min or to 999 hs 59 min. Select setting 999:59.



When changing the maximum duration setting, pre-existing programs will be deleted in the program editor.

- **Turning off the tolerance limits function**

Select setting “0” meaning tolerance limits off. Thus an interruption of the program course during the heating-up or cooling-down phases during the rapid “set-point step” phase is avoided.

- **Inactivating the week program timer**

Inactivate the week program timer before entering a program (factory setting). Otherwise, any setting of the operation lines in the program editor is ineffective.

Normal Display

Display 1 shows	e.g. 19.8	(actual temperature value)
Display 2 shows	e.g. 15.05.06 13:52 - -	(actual date and time, actual state of week program timer channel 1: Off, channel 2: Off)

Hit key  ↓ for 5 sec

Display 1 shows	e.g. 0000	
Display 2 shows	PROGRAM EDITOR	(you are in the program editor)

it key  ↓ for 5 sec

Display 1 shows	0000	Menu visible only if week program timer is activated
Display 2 shows	WEEK PROG. EDITOR	(you are in the week program editor)

Hit key  ↓ for 5 sec

Display 1 shows	0000	
Display 2 shows	USER-LEVEL	(you are in the user level)

Hit program key  ↓

Display 1 shows	0000	
Display 2 shows	UserCod? 0000	(enter user code, display flashes)

Enter the user code with arrow keys   ↓ e.g. **0001** (basic setting, or the valid code in case it has been previously changed in this menu). Value is displayed in both displays.



Automatically forward after 2 sec

↓

Display 1 shows	1	(actual address)
Display 2 shows	Adress 1	(entry of chamber address) (actual address: 1)



Hit several times key  ↓ until **Prg.Time** appears:

Display 1 shows	0000	
Display 2 shows	Prg.Time: 999:59	(max. section length 99:59 or 999:59?) (actual setting: 999:59)

Select **999:59** in hhh:mm with arrow keys   ↓ Setting is displayed in display 2.



Hit key  ↓

Display 1 shows	0000	
Display 2 shows	Tol.Band 0	(Tolerance limits in °C) (actual setting: 0)

Set value **0** meaning tolerance limits off with arrow keys   ↓ Setting is displayed in display 2.

Hit key  ↓

Display 1 shows	0000	
Display 2 shows	Prog.Clk Inactive	(Week program timer active or inactive?) (actual setting: Inactive)

Select "**Inactive**" meaning week program timer off, with arrow keys   ↓ Setting is displayed in display 2.

Hit several times key EXIT ↓ or wait 120 sec.

Controller returns to Normal Display.

2. Enter the time program to the program editor

Program table for the example program:

Section	Temperature set-point [°C]	Section length [hh.mm]	Fan speed [%]	Operation lines
SEC	TEMP	TIME	FAN	O.LINE
S01	60	119:59	100	000
S02	60	000:01	100	000
S03	30	047:59	100	000
S04	30	000:01	100	000

In this example the program is entered to the first program place (P01).

Normal display

Display 1 shows	e.g. 19.8	(actual temperature value)
Display 2 shows	e.g. 15.05.06 13:52 --	(actual date and time, actual switching state of week program timer channel 1: Off, channel 2: Off)



Hit key  ↓ for 5 sec.

Display 1 shows	e.g. 0000	
Display 2 shows	PROGRAM EDITOR	(you are in the program editor)

Hit program key  ↓



Display 1 shows	0000	
Display 2 shows	UserCod? 0000	(enter user code)

Enter user code with arrow keys   ↓ e.g. **0001** (basic setting, adjustable in the user level, chap. 10). Value is displayed in both displays.

Automatically forward after 2 sec.



Display 1 shows	01	program P01 selected
Display 2 shows	---:--- PRG.	program can be selected
alternating	CONTINUE X/W	(information: to 1 st program section with X/W)

Select program **P01** with arrow keys   ↓ Value is displayed in Display 1.

Hit key  ↓



In the selected program P01 the first program section S01 is displayed:

Display 1 shows	01	section S01 has been selected
Display 2 shows alternating	P01: --- SEC.	enter new set-points for the individual variables with button X/W.
	CONTINUE X/W or NEW SEC. X/W	

Select section S01 with arrow keys   ↓

Hit key  ↓

Display 1 shows	60.0 ^{°C}	(actual temperature set-point)
Display 2 shows alternating	S01: TEMP 60.0	(variable: temperature in °C)
	CONTINUE X/W	(information: go on with X/W)

Entry of temperature set-point of **60 °C** with arrow keys   ↓



Hit key  ↓

Display 1 shows	119	(actual section length set-point)
Display 2 shows alternating	S01: TIME 119:59	(variable: section length in hhh:mm)
	CONTINUE X/W	(information: go on with X/W)

Enter section length set-point of S01 of **119 hs. 59 min.** with arrow keys   ↓ Value is displayed in both displays.



Hit several times key  ↓ until **P01: --- SEC** appears:

Display 1 shows	02	section S02 has been selected
Display 2 shows alternating	P01: --- SEC.	enter new set-points for the individual variables with button X/W.
	CONTINUE X/W or NEW SEC. X/W	

Select section S02 with arrow keys   ↓

Hit key  ↓

Display 1 shows	60.0 ^{°C}	(actual temperature set-point)
Display 2 shows alternating	S02: TEMP 60.0	(variable: temperature in °C)
	CONTINUE X/W	(information: go on with X/W)

Entry of temperature set-point of **60** in °C of S02 with arrow keys   ↓



Hit key  ↓

Display 1 shows	000	(actual section length set-point)
Display 2 shows alternating	S02: TIME 000:01	(variable: section length in hhh:mm)
	CONTINUE X/W	(information: go on with X/W)

Enter section length set-point of S02 of **1 min** with arrow keys   ↓ Value is displayed in both displays.



Hit several times key  ↓ until **P01: --- SEC** appears:

Display 1 shows	03	section S03 has been selected
Display 2 shows alternating	P01: --- SEC.	enter new set-points for the individual variables with button X/W.
	CONTINUE X/W	
	or NEW SEC. X/W	

Select section S03 with arrow keys   ↓

Hit key  ↓

Display 1 shows	30 ^{°C}	(actual temperature set-point)
Display 2 shows alternating	S03:TEMP 30	(variable: temperature in °C)
	CONTINUE X/W	(information: go on with X/W)

Entry of temperature set-point of **30 °C** of S03 with arrow keys   ↓



Hit key  ↓

Display 1 shows	047	(actual section length set-point)
Display 2 shows alternating	S03: TIME 047:59	(variable: section length in hhh:mm)
	CONTINUE X/W	(information: go on with X/W)

Enter section length set-point of S03 of **47 hs. 59 min.** with arrow keys   ↓ Value is displayed in both displays.



Hit several times key  ↓ until **P01: --- SEC** appears:

Display 1 shows	04	section S04 has been selected
Display 2 shows alternating	P01: --- SEC.	enter new set-points for the individual variables with button X/W.
	CONTINUE X/W	
	or NEW SEC. X/W	

Select section S04 with arrow keys   ↓

Hit key  ↓

Display 1 shows	30 ^{°C}	(actual temperature set-point)
Display 2 shows	S04:TEMP 30	(variable: temperature in °C)
alternating	CONTINUE X/W	(information: go on with X/W)

Entry of temperature set-point of **30 °C** of S04 with arrow keys   ↓

Hit key  ↓

Display 1 shows	000	(actual section length set-point)
Display 2 shows	S04: TIME 000:01	(variable: section length in hhh:mm)
alternating	CONTINUE X/W	(information: go on with X/W)

Enter section length set-point of S04 of **1 min.** with arrow keys   ↓ Value is displayed in both displays.

Hit key EXIT ↓ several times or wait 120 sec.

Controller returns to Normal Display



Make sure that there are no more program sections (S05 etc.) existing due to previous programming. If so, they must be deleted (see chap. 8.4)

3. Set the number of cycles to infinite in the program start level and start the program



The described example program must be started once at the precise moment of temperature change (on Monday e.g., at 0.01 or at 7.00). If the program cannot be manually started at the desired moment, a suitable program delay-time of 99 hs. 59 min. max. can be programmed. After rundown of this delay time the program starts automatically (see chap. 9).

Normal Display



Hit program key  ↓

Display 1 shows	1	actually selected program
Display 2 shows	SEL.PRG.	select program 1 or 2

Enter program number 1 with arrow keys   ↓ Value is displayed in display 1.

Hit program key  ↓

Display 1 shows	e.g. 00.00	(entered delay time hh.mm)
Display 2 shows	RUN TIME	(enter delay time of program start)

Set delay time, if desired, in hh.mm with arrow keys   ↓ Setting 00.00 means no delay time (immediate program start)
Value is displayed in display 1.

Hit program key  ↓

Display 1 shows	-1	actually selected number of program cycles: infinite
Display 2 shows	REPEAT	(enter number of program cycles)

Select number of cycles -1, i.e. infinite repeats, with arrow keys   ↓ Value is displayed in display 1.

Hit program key  ↓

Display 1 shows	1	selected program
Display 2 shows	RUN PRG.	Question: start selected program?

Hit program key  ↓

Display 1 shows	20.0 ^c	actual temperature value
Display 2 shows	P01:S01 119:49 (time running backwards)	actual program P01, actual section S01, and remaining time of program section S01

Program is running. The green LED (3d) lights up.

Additionally to the green LED (3d) indicating a running program LED (3a) is lit if the heating is active, or no LED if the actual temperature equals the set-point.

During program course the arrow keys and the EXIT button are not functional.



By hitting the program key  the program course can be terminated.

If during program course button  is hit, the entered set-points of the actually running program section are shown one after the other for 5 sec. each.

13. Behavior at failures

13.1 Behavior after power failure

Power failure during fixed-value operation (Normal Display): the entered parameters remain saved. After power return operation continues with the set parameters.

Power failure during program operation: After power return program course continues with the set-points that have been reached during program operation.

13.2 Alarm messages

Alarm messages, e.g. "RANGE ERROR CH1" in case of sensor rupture, are displayed in Display 2 only in Normal Display.

A buzzer can be activated / inactivated in the user level (chap. 10). It can be reset by pressing the **EXIT** button. The alarm text displayed in Normal Display goes off only if the alarm cause does not exist any longer.

14. Temperature safety devices

14.1 Temperature safety device class 2 (DIN 12880)

The temperature safety device class 2 acc. to DIN 12880:2007 protects the chamber, its environment and the charging material from exceeding the maximum permissible temperature.

Please observe the DGUV guidelines 213-850 on safe working in laboratories (formerly BGI/GUV-I 850-0, BGR/GUV-R 120 or ZH 1/119, issued by the employers' liability insurance association) (for Germany).

In the event of a fault in the temperature controller, the safety device (2) **permanently** turns off the chamber. This status is reported visually by the indicator lamp (2a).

Check the operation of the safety device (2) by moving it slowly counter-clockwise until the chamber turns off. The safety device cut-off is reported visually by the indicator lamp (2a).

Then release again the safety device by pressing the reset button (2b), and turn on the chamber as described.

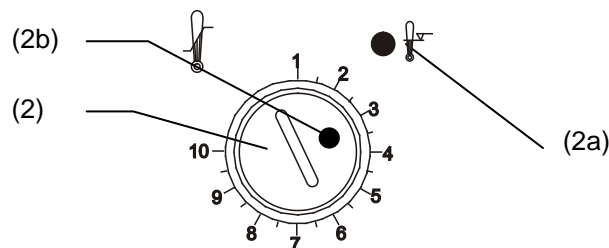

Figure 8: Safety thermostat class 2

Function:

The safety device class 2 is functionally and electrically independent of the temperature control device and turns off the chamber **permanently**.

If you turn the control knob (2) to its end stop (position 10), the safety device protects the appliance. If you set it to a temperature a little above the controller's set-point temperature, it protects the charging material.

If the safety device has turned off the chamber, identifiable by the red alarm lamp (2a), lighting up, proceed as follows:

- Disconnect the chamber from the power supply
- Have an expert examine and rectify the cause of the fault
- Release the safety device by pressing the reset button (2b)
- Start the chamber again as described in chap. 5

Setting:

To check the response temperature of the safety device, turn on the chamber and set the desired set-point at the temperature controller.

The scale division from 1 to 10 corresponds to the temperature range from 30 °C up to 320 °C and serves as a setting aid.

- Turn the control knob (2) of the safety device using a coin to its end-stop (position 10) (chamber protection).
- When the set point is reached, turn back the control knob (2) until its trip point (turn it counter-clockwise).
- The trip point is identifiable by the red alarm lamp (2a) lighting up; the reset button (2b) pops out.
- The optimum setting of the safety device is obtained by turning the knob clockwise by approx. one graduation mark on the scale.
- Push the reset button (2b) in again.

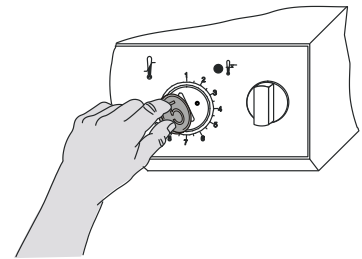

Figure 9: Setting the safety device class 2



The chamber is only active with the reset button (2b) pushed in.

When the safety device class 2 responds, the red alarm lamp (2a) illuminates, the reset button (2b) pops out, and the chamber turns off permanently.



Check the safety device with every change of the set point value and readjust it if necessary.

Function check:

Check the temperature safety device class 2 at appropriate intervals for its functionality. It is recommended that the authorized operating personnel should perform such a check, e.g., before starting a longer work procedure.

14.2 Temperature safety device class 3.1 (DIN 12880) (option)

The temperature safety device class 3.1 acc. to DIN 12880:2007 protects the chamber, its environment and the charging material from exceeding the maximum permissible temperature. In the event of a fault, it limits the temperature inside the oven to the value set on the safety device.

Please observe the DGUV guidelines 213-850 on safe working in laboratories (formerly BGI/GUV-I 850-0, BGR/GUV-R 120 or ZH 1/119, issued by the employers' liability insurance association) (for Germany).

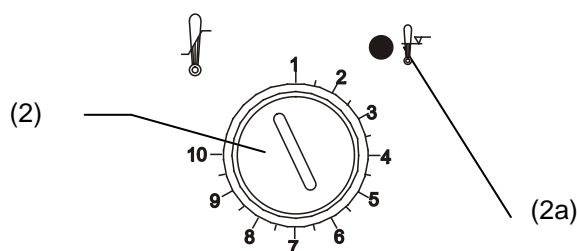

Figure 10: Temperature safety device class 3.3

Function:

The temperature safety device is functionally and electrically independent of the temperature control system and if an error occurs it performs a regulatory function.

If you turn the control knob (2) to its end-stop (position 10), the safety device class 3.1 protects the chamber. If you set it to a temperature a little above the controller's set-point temperature, it protects the charging material.

If the safety device class 3.1 has taken over control, identifiable by the red alarm lamp (2a) lighting up, proceed as follows:

- Disconnect the chamber from the power supply
- Have an expert examine and rectify the cause of the fault
- Start up the chamber again as described in chap. 5

Setting:

To check the response temperature of the safety device class 3.1, turn on the chamber and set the desired set-point at the temperature controller.

The sections of the scale from 1 to 10 correspond to the temperature range from 63 °C to 350 °C and serve as a setting aid.

- Turn the control knob (2) of the safety device using a coin to its end-stop (position 10) (chamber protection).
- When the set point is reached, turn back the control knob (2) until its trip point (turn it counter-clockwise).
- The trip point is identifiable by the red alarm lamp (2a) lighting up.
- The optimum setting for the safety device is obtained by turning the control knob clockwise by approximately one scale division, which leads to extinguish the red alarm lamp.

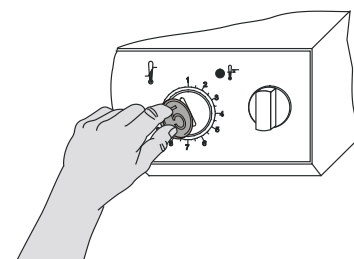

Figure 11: Setting the safety device class 3.1



Check the setting regularly and adjust it following any changes of the set-point.

Function check:

Check the temperature safety device class 3.1 at appropriate intervals for its functionality. It is recommended that the authorized operating personnel should perform such a check, e.g., before starting a longer work procedure.

15. Options

15.1 Communication software APT-COM™ 3 DataControlSystem (option)

The chamber is regularly equipped with a serial interface RS 422 to which the BINDER communication software APT-COM™ 3 DataControlSystem can be connected. The connection to a computer is established using the FP interface via an interface converter RS 422 / RS 232.



Make sure that the interface mode is correctly set to “Modbus” in the user level (chap. 10).

In adjustable intervals the actual temperature, and fan speed values are put out. Programming can be performed graphically via PC. Up to 30 chambers with RS 422 interface can be cross linked. For further information, refer to the operating manual of the BINDER communication software APT-COM™.

Pin allocation of the RS 422 interface at the rear of the oven:	Pin 2:	RxD (+)
	Pin 3:	TxD (+)
	Pin 4:	RxD (-)
	Pin 5:	TxD (-)
	Pin 7:	Ground

15.2 Data logger kit (option)

BINDER Data Logger Kits offer an independent long-term measuring system for temperature. They are equipped with a keyboard and a large LCD display, alarm functions and a real-time function. Measurement data are recorded in the Data Logger and can be read out after the measurement via the RS232 interface of the Data Logger. It offers a programmable measuring interval and permits storing up to 64000 measuring values. Reading out is done with the Data Logger evaluation software. You can give out a combined alarm and status protocol directly to a serial printer.

Data Logger Kit T 350: Temperature range 0 °C / 32 °F up to +350 °C / 662 °F



For detailed information on installation and operation of the BINDER Data Logger, please refer to the mounting instructions Art. No. 7001-0204 and to the original user manual of the manufacturer, supplied with the data logger.

15.3 Additional measuring channel for digital object temperature indicator with flexible temperature sensor Pt 100 (option)

The object temperature display enables the determination of the actual temperature of the specimen during the whole process. The object temperature is measured via a flexible Pt 100 temperature sensor and can be viewed at Display 2 of the RD3 controller.

The object temperature data is put out together with the data of the temperature controller to the RS 422 interface as a second measuring channel and can be documented by the communication software APT-COM™ developed by BINDER (option, chap. 15.1).

The sensor top protective tube of the flexible Pt 100 can be immersed into liquid substances.

Technical data of the Pt 100 sensor:

- Three-wire technique
- Class B (DIN EN 60751)
- Temperature range up to 320 °C
- Stainless steel protective tube 45 mm length, material no. 1.4501

15.4 Analog output for temperature (option)

With this option the chamber is equipped with an analog output 4-20 mA for temperature. This output permits transmitting data to external data registration systems or devices.

The connection is carried out as a DIN socket at the rear of the chamber as following:



ANALOG OUTPUT 4-20 mA DC

PIN 1: Temperature –

PIN 2: Temperature +

Temperature range: 0 °C to 300 °C

A suitable DIN plug is enclosed.

Figure 12: Pin configuration of the DIN socket

15.5 Zero-voltage relay outputs via operation lines (option)

Operation lines 1, 2 und 3 are used to switch any device connected to the zero-voltage relay outputs via a DIN socket at the rear of the incubator. The operation lines permit turning on and off the individual zero-voltage relay outputs through the program controller. They can be programmed in fixed value entry mode (chap. 6) as well as in the program editor (chap. 8.2) via the operation lines (switching state 0 = Off, switching state 1 = On).

Connection occurs via the DIN socket at the rear of the chamber as following:

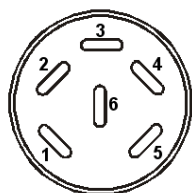
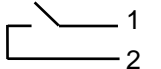
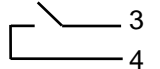
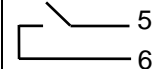



Figure 13: Pin configuration of the DIN socket

A suitable DIN plug is enclosed.

Operation line 1	Operation line 2	Operation line 3
 Pin 1: Pin Pin 2: Make	 Pin 3: Pin Pin 4: Make	 Pin 5: Pin Pin 6: Make
Switching state On: 1xx	Switching state On: x1x	Switching state On: xx1

Maximum loading capacity of the switching contacts: 24V AC/DC – 2.5 A

	 DANGER
	<p>Electrical hazard.</p> <p>Danger of death.</p> <p>Damage to switching contacts and connection socket.</p> <ul style="list-style-type: none"> ⊘ Do NOT exceed the maximum switching load of 24V AC/DC – 2.5A. ⊘ Do NOT connect any devices with a higher loading capacity.

15.6 HEPA fresh air filter (option)

With this option, the introduced fresh air is cleaned by means of a high efficiency submicron particulate air filter type HEPA class H 14 (acc. to DIN EN 1822:2009). Replace the filter insert, if necessary, by removing the metal cover of the filter at the left side of the chamber (Art. No. 6014-0003).

15.7 Mostly gas-tight version (option for FP 53 and FP 115)

With this option the drying and heating oven is additionally sealed, so the loss when introducing gases is decreased. The chamber is not completely gas-tight, so it is impossible to establish overpressure. The sealing diminishes the release of vapors via the housing that may be set free from the charging material when heated. Carrying-off via the regular evacuation duct, e.g. into a waste air installation, is likely to further reduce emissions.

	<p>The chamber is not completely gas-tight. Gases from inside the chamber can escape into the surrounding atmosphere.</p> <p>Observe the occupational exposure limit OEL for the released substance set by the national authorities (formerly maximum permitted workplace concentration). Respect the relevant regulations.</p> <p>Any harmful gas that might escape has to be led out via good room ventilation or a suitable exhaust system. Place the chamber, if necessary, below a gas vent.</p>
---	---

The air flap does not close the exhaust duct completely. The delivered plug serves to avoid emerging of vapors or loss of introduced inert gas, if any, via the exhaust duct. Due to special demands of heat resistance, use the delivered plug only.

	<h3>CAUTION</h3>
	<p>Use of inappropriate plug.</p> <p>Danger of inflammation.</p> <p>➤ To close the exhaust duct use the delivered plug only.</p>

For drying purpose, please remove the plug in order to permit dissipation of the generated vapor, which would lead to condensation in the inner chamber.

15.8 Inert gas connection with mostly gas-tight version (option for FP 53 and FP 115)

With this option the drying and heating oven is additionally sealed, so the loss when introducing inert gases is decreased. For details on the mostly gas-tight version please refer to chap. 15.7.

The drying and heating oven is equipped with two ports for inert gas (nitrogen or noble gases).

The ports are located **on the top panel in the middle** and **on the right side at the bottom right**. Each of these ports can be used as inlet or outlet, depending on the nature of the inert gas:

- lighter gas (nitrogen, helium): lower port as inlet
- heavy gas (e.g. argon): upper port as inlet

Connection

Observe the legal requirements and relevant standards and regulations for the safe handling of gas cylinders and inert gases.

	<p>General information for safe handling of gas cylinders:</p> <ul style="list-style-type: none"> • Store and use gas cylinders only in well ventilated areas. • Open the gas cylinder valve slowly to avoid pressure surges • Secure gas cylinders during storage and use against falling (chaining). • Transport gas cylinders with a cylinder cart, do not carry, roll, or throw them • Always close the valve even with apparently empty cylinders; screw on the cap when not in use. Return gas cylinders with the valve closed • Do not open gas cylinders by force. Mark them when damaged • Observe relevant regulations for dealing with gas cylinders.
---	---



Connect a flexible gas tube to the gas hose connection adapter (diameter 10mm), which is used for gas inlet, and secure it with hose clamps (hose and hose clamps are not enclosed). There is a constant gas flow after establishing the connection.

	<p>After connecting the gas cylinder, check all gas connections for leaks (e.g. with leak spray or diluted soap solution).</p>
---	--

Use a pressure reducer and make sure to avoid any excessive outlet pressure when connecting the gas hose to the oven.

	<p>The chamber is not completely gas-tight. Inert gases from inside the chamber can escape into the surrounding atmosphere.</p>
--	---

Inert gases in high concentrations are hazardous to health. They are colorless and almost odorless and therefore practically imperceptible. Inhalation of inert gases can cause drowsiness up to respiratory arrest. When the O₂ content of the air decreases below 18%, there is risk of death from lack of oxygen. Any gas that might escape has to be led out via good room ventilation or a suitable exhaust system.

	 WARNING
	<p>High concentration of inert gas. Risk of death by suffocation.</p> <ul style="list-style-type: none"> ⊘ Do NOT set up chambers in non-ventilated recesses. ➤ Ensure technical ventilation measures. ➤ Respect the relevant regulations for handling these gases.

	<p>Inert gases, which are heavier than air, may accumulate in low-lying areas of the installation site.</p>
---	---

The “Mostly gas-tight version” reduces the loss of gas.

Setting (sample values):

If you want to flush the chamber with an air exchange rate of 1 per hour, set the flow rate on the pressure reducer according to the interior volume.

FP 53 with 53 l internal volume: The flow rate corresponding to 53 l / h is 0.9 l / min.

FP 115 with 115 l internal volume: The flow rate corresponding to 115 l / h is 1.9 l / min.

Without the “Mostly gas-tight version” option, you may need to slightly increase the flow rate.



The air flap does not close the exhaust duct completely. The delivered plug serves to avoid loss of introduced inert gas via the exhaust duct. Due to special demands of heat resistance, use the delivered plug only.

	CAUTION
	<p>Use of inappropriate plug.</p> <p>Danger of inflammation.</p> <p>➤ To close the exhaust duct use the delivered plug only.</p>

For drying purpose, please remove the plug in order to permit dissipation of the generated vapor, which would lead to condensation in the inner chamber.

16. Maintenance, cleaning, and service

16.1 Maintenance intervals, service

 	 DANGER
	<p>Electrical hazard.</p> <p>Danger of death.</p> <ul style="list-style-type: none"> ⊘ The chamber must NOT become wet during operation or maintenance work. ⊘ Do NOT remove the rear panel of the chamber. ➤ Before conducting maintenance work, turn off the chamber at the main power switch and disconnect the power plug. ➤ Ensure all maintenance work is conducted by licensed electricians or experts authorized by BINDER.

Ensure regular maintenance work is carried out at least once a year.

	The warranty becomes void if maintenance work is conducted by non-authorized personnel.
---	---

	Replace the door gasket only when cold. Otherwise, the door gasket may become damaged.
---	--



We recommend taking out a maintenance agreement. Please consult BINDER Service.

BINDER telephone hotline:	+49 (0) 7462 2005 555
BINDER fax hotline:	+49 (0) 7462 2005 93555
BINDER e-mail hotline:	service@binder-world.com
BINDER service hotline USA:	+1 866 885 9794 or +1 631 224 4340 x3 (toll-free in the USA)
BINDER service hotline Asia Pacific:	+852 390 705 04 or +852 390 705 03
BINDER service hotline Russia and CIS:	+7 495 988 15 16
BINDER Internet website:	http://www.binder-world.com
BINDER address:	BINDER GmbH, post office box 102, D-78502 Tuttlingen

International customers, please contact your local BINDER distributor.

16.2 Cleaning and decontamination

Clean the chamber after each use to avoid potential corrosion damage by ingredients of the test material.

	 DANGER
	<p>Electrical hazard.</p> <p>Danger of death.</p> <ul style="list-style-type: none"> ⊘ Do NOT spill water or cleaning agents over the inner and outer surfaces. ➤ Before cleaning, turn off the chamber at the main power switch and disconnect the power plug. ➤ Completely dry the appliance before turning it on again.

16.2.1 Cleaning

Disconnect the chamber from the power supply before cleaning. Disconnect the power plug.

	<p>The interior of the chamber must be kept clean. Thoroughly remove any residues of the charging material</p>
---	--

Wipe the surfaces with a moistened towel. In addition, you can use the following cleaning agents:

Exterior surfaces inner chamber shelves door gaskets	Standard commercial cleaning detergents free from acid or halides. Alcohol-based solutions. We recommend using the neutral cleaning agent Art. No. 1002-0016.
Instrument panel	Standard commercial cleaning detergents free from acid or halides. We recommend using the neutral cleaning agent Art. No. 1002-0016.
Zinc coated hinge parts rear chamber wall	Standard commercial cleaning detergents free from acid or halides. Do NOT use a neutral cleaning agent on zinc coated surfaces.

Do not use cleaning agents that may cause a hazard due to reaction with components of the device or the charging material. If there is doubt regarding the suitability of cleaning products, please contact BINDER service.

	<p>We recommend using the neutral cleaning agent Art. No. Art. Nr. 1002-0016 for a thorough cleaning.</p> <p>Any corrosive damage that may arise following use of other cleaning agents is excluded from liability by BINDER GmbH.</p> <p>Any corrosive damage caused by a lack of cleaning, is excluded from liability by BINDER GmbH.</p>
---	---

	CAUTION
	<p>Danger of corrosion.</p> <p>Damage to the chamber.</p> <ul style="list-style-type: none"> ⊘ Do NOT use acidic or chlorine cleaning detergents. ⊘ Do NOT use a neutral cleaning agent on other kind of surfaces e.g., the zinc coated hinge parts or the rear chamber wall.

	For surface protection, perform cleaning as quickly as possible. After cleaning, completely remove cleaning agents from the surfaces with a moistened towel. Let the chamber dry.
---	---



	Soapsuds may contain chlorides and must therefore NOT be used for cleaning.
---	---

	With every decontamination method, always use adequate personal safety controls.
---	--

Following cleaning, leave the chamber door open or remove the access port plugs.

	The neutral cleaning agent may cause health problems in contact with skin and if ingested. Follow the operating instructions and safety hints labeled on the bottle of the neutral cleaning agent.
---	---

Recommended precautions: To protect the eyes use sealed protective goggles. Suitable protective gloves with full contact: butyl or nitrile rubber, penetration time >480 minutes.

	 CAUTION
	<p>Contact with skin, ingestion.</p> <p>Skin and eye damage due to chemical burns.</p> <ul style="list-style-type: none"> ∅ Do not ingest. Keep away from food and beverages. ∅ Do NOT empty into drains. ➤ Wear protective gloves and goggles. ➤ Avoid skin contact.

16.2.2 Decontamination

The operator must ensure that proper decontamination is performed in case a contamination of the chamber by hazardous substances has occurred.

Disconnect the chamber from the power supply prior to decontamination. Pull the power plug.

Do not use decontamination agents that may cause a hazard due to reaction with components of the device or the charging material. If there is doubt regarding the suitability of cleaning products, please contact BINDER service.

You can use the following disinfectants:

Inner chamber	Standard commercial surface disinfectants free from acid or halides. Alcohol-based solutions. We recommend using the disinfectant spray Art. No. 1002-0022.
---------------	---

	For chemical disinfection, we recommend using the disinfectant spray Art. No. 1002-0022. Any corrosive damage that may arise following use of other disinfectants is excluded from liability by BINDER GmbH.
---	---



	With every decontamination method, always use adequate personal safety controls.
---	--

In case of impurity of the interior with biological or chemical hazardous goods, there are three possible procedures depending on the type of contamination and of the charging material.

- (1) The drying and heating ovens FP can be hot air sterilized at 190 °C for at least 30 minutes. All inflammable goods must be removed from the interior before.
- (2) Spray the inner chamber with an appropriate disinfectant.
Before start-up, the chamber must be absolute dry and ventilated, because explosive gases may form during the decontamination process.
- (3) If necessary, have strongly contaminated inner chamber parts removed by an engineer for cleaning, or have them exchanged. Sterilize the inner chamber parts in a sterilizer or autoclave.

	In case of eye contact, the disinfectant spray may cause eye damage due to chemical burns. Follow the operating instructions and safety hints labeled on the bottle of the disinfectant spray.
---	--

Recommended precautions: To protect the eyes use sealed protective goggles.

	 CAUTION
	<p>Eye contact. Eye damage due to chemical burns.</p> <p>Ø Do NOT empty into drains. ➤ Wear protective goggles.</p>

	After using the disinfectant spray, allow the chamber to dry thoroughly, and aerate it sufficiently.
---	--

16.3 Sending back the chamber to BINDER GmbH

If you send a BINDER product to us for repair or any other reason, we will only accept the product upon presentation of an authorization number that has previously been issued to you. We will issue an **authorization number** (RMA number) after receiving your complaint either in writing or by telephone **prior** to your sending the BINDER product back to us. The authorization number will be issued following receipt of the information mentioned below:

- BINDER product type and serial number
- Date of purchase
- Name and address of the dealer from which you bought the BINDER product
- Exact description of defect or fault
- Your full address; if possible contact person and availability of that person
- Exact location of the BINDER product
- Contamination clearance certificate (chap. 22) via fax in advance

The authorization number needs to be applied to the packaging in such a way that it can be easily recognized or be recorded clearly in the delivery documents.

	For security reasons we cannot accept your delivery if it does not carry an authorization number.
---	---

Return address: BINDER GmbH Gänsäcker 16
Abteilung Service 78502 Tuttlingen
Germany

17. Disposal

17.1 Disposal of the transport packing

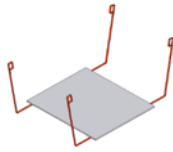
Packing element	Material	Disposal
Straps to fix packing on pallet	Plastic	Plastic recycling
Wooden transport box (option) with metal screws	Non-wood (compressed matchwood, IPPC standard)	Wood recycling
	Metal	Metal recycling
Pallet (from size 115 on) with foamed plastic stuffing	Solid wood (IPPC standard)	Wood recycling
	PE foam	Plastic recycling
Transport box with metal clamps	Cardboard	Paper recycling
	Metal	Metal recycling
Top cover (size 720 only)	Cardboard	Paper recycling
Removal aid (sizes 240 and 400 only) 	Cardboard	Paper recycling
	Plastic	Plastic recycling
Edge protection	Styropor® or PE foam	Plastic recycling
Protection of doors and racks	PE foam	Plastic recycling
Bag for operating manual	PE foil	Plastic recycling
Insulating air cushion foil (packing of optional accessories)	PE foil	Plastic recycling



If recycling is impossible, all packing parts can also be disposed of with normal waste.

17.2 Decommissioning

Turn off the main power switch (1) and disconnect the chamber from the power supply (pull the power plug).

	When turning off the main power switch ON / OFF (1), the stored parameters remain saved.
---	--

- With option inert gas connection (chap. 15.8): Close the inert gas supply and remove the gas connection.

	 WARNING
	<p>High concentration of inert gas. Risk of death by suffocation.</p> <ul style="list-style-type: none"> ➤ Respect the relevant regulations for handling these gases. ➤ When decommissioning the chamber, turn off the inert gas supply.

- Temporal decommissioning: See indications for appropriate storage, chap. 3.3.
- Final decommissioning: Dispose of the chamber as described in chap. 17.3 to 17.5.

17.3 Disposal of the chamber in the Federal Republic of Germany

According to Annex I of Directive 2012/19/EU of the European Parliament and of the Council on waste electrical and electronic equipment (WEEE), BINDER devices are classified as “monitoring and control instruments” (category 9) only intended for professional use“. They must not be disposed of at public collecting points.

The chambers bear the symbol for the marking of electrical and electronic equipment manufactured / placed on the market in the EC after 13 August 2005 and be disposed of in separate collection according to Directive 2012/19/EU on waste electrical and electronic equipment (WEEE) and German national law for electrical and electronic equipment (Elektro- und Elektronikgerätegesetz, ElektroG). WEEE marking: crossed-out wheeled bin with solid bar under. A significant part of the materials must be recycled in order to protect the environment.

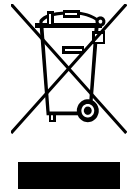



At the end of the device’s service life, have the device disposed of according to the German national law for electrical and electronic equipment (Elektro- und Elektronikgerätegesetz, ElektroG from 20 October 2015, BGBl. I p. 1739) or contact BINDER service who will organize taking back and disposal of the chamber according to the German national law for electrical and electronic equipment (Elektro- und Elektronikgerätegesetz, ElektroG from 20 October 2015, BGBl. I p. 1739).

	CAUTION
	<p>Violation against existing law.</p> <ul style="list-style-type: none"> ⊘ Do NOT dispose of BINDER devices at public collecting points. ➤ Have the device disposed of professionally at a recycling company which is certified according to the German national law for electrical and electronic equipment (Elektro- und Elektronikgerätegesetz, ElektroG from 20 October 2015, BGBl. I p. 1739). <li style="padding-left: 20px;"><i>or</i> ➤ Instruct BINDER Service to dispose of the device. The general terms of payment and delivery of BINDER GmbH apply, which were valid at the time of purchasing the chamber.

Certified companies disassemble waste BINDER equipment in primary substances for recycling according to Directive 2012/19/EU. In order to eliminate any health hazards to the employees of the recycling companies, the devices must be free from toxic, infectious or radioactive substances.

	<p>It is the user’s responsibility that the chamber is free from toxic, infectious or radioactive substances prior to handing it over to a recycling company.</p> <ul style="list-style-type: none"> • Prior to disposal, clean all introduced or residual toxic substances from the chamber. • Prior to disposal, disinfect the chamber from all sources of infection. Be aware of the fact that sources of infection may also be located outside the inner chamber. • If you cannot safely remove all toxic substances and sources of infection from the chamber, dispose of it as special waste according to national law. • Fill out the contamination clearance certificate (chap. 22) and enclose it with the chamber.
---	--

 	 WARNING
	<p>Contamination of the device with toxic, infectious or radioactive substances.</p> <p>Danger of intoxication.</p> <p>Danger of infection.</p> <ul style="list-style-type: none"> ⊘ NEVER take a chamber contaminated with toxic substances or sources of infection for recycling according to Directive 2012/19/EU. ➤ Prior to disposal, remove all toxic substances and sources of infection from the chamber. ➤ Dispose of a chamber from which all toxic substances or sources of infection cannot be safely removed as special waste according to national law.

17.4 Disposal of the chamber in the member states of the EC except for the Federal Republic of Germany

According to Annex I of Directive 2012/19/EU of the European Parliament and of the Council on waste electrical and electronic equipment (WEEE), BINDER devices are classified as “monitoring and control instruments” (category 9) only intended for professional use“. They must not be disposed of at public collecting points.

The chambers bear the symbol for the marking of electrical and electronic equipment manufactured / placed on the market in the EC after 13 August 2005 and be disposed of in separate collection according to the Directive 2012/19/EU on waste electrical and electronic equipment (WEEE). WEEE marking: crossed-out wheeled bin with solid bar under.

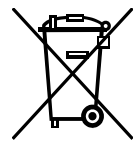





At the end of the device’s service life, notify the distributor who sold you the device, who will take back and dispose of the chamber according to the Directive 2012/19/EU on waste electrical and electronic equipment (WEEE).



	CAUTION
	<p>Violation against existing law.</p> <ul style="list-style-type: none"> ⊘ Do NOT dispose of BINDER devices at public collecting points. ➤ Have the device disposed of professionally at a recycling company which is certified according to conversion of the Directive 2012/19/EU into national law. <i>or</i> ➤ Instruct the distributor who sold you the device to dispose of it. The agreements apply that were reached with the distributor when purchasing the chamber (e.g. his general terms of payment and delivery). ➤ If your distributor is not able to take back and dispose of the chamber, please contact BINDER service.

Certified companies disassemble waste BINDER equipment in primary substances for recycling according to Directive 2012/19/EU. In order to exclude any health hazard for the employees of the recycling companies, the devices must be free from toxic, infectious or radioactive substances.

	<p>It is the user's responsibility that the chamber is free from toxic, infectious or radioactive substances prior to handing it over to a recycling company.</p> <ul style="list-style-type: none"> • Prior to disposal, clean all introduced or residual toxic substances from the chamber. • Prior to disposal, disinfect the chamber from all sources of infection. Be aware of the fact that sources of infection may also be located outside the inner chamber. • If you cannot safely remove all sources of infection and toxic substances from the chamber, dispose of it as special waste according to national law. • Fill out the contamination clearance certificate (chap. 22) and enclose it with the chamber.
---	--

	<p style="text-align: center;"> WARNING</p>
	<p>Contamination of the device with toxic, infectious or radioactive substances.</p> <p>Danger of intoxication.</p> <p>Danger of infection.</p> <ul style="list-style-type: none"> ⊘ NEVER take a chamber contaminated with toxic substances or sources of infection for recycling according to Directive 2012/19/EU. ➤ Prior to disposal, remove all toxic substances and sources of infection from the chamber. ➤ Dispose of a chamber from which all toxic substances or sources of infection cannot be safely removed as special waste according to national law.
	

17.5 Disposal of the chamber in non-member states of the EC

	<p style="text-align: center;">CAUTION</p>
	<p>Alteration of the environment.</p> <ul style="list-style-type: none"> ➤ For final decommissioning and disposal of the oven, please contact BINDER Service. ➤ Observe the statutory regulations for appropriate, environmentally friendly disposal.

The main board of the drying and heating oven includes a lithium cell. Please dispose of it according to national regulations.

18. Troubleshooting

Fault description	Possible fault cause	Required measures
Heating		
Set-point temperature is not reached after specified time.	Chamber door not properly closed.	Completely close chamber door.
	Door gasket defective.	Replace door gasket,
	Controller not adjusted.	Calibrate and adjust controller.
Chamber heating permanently, set-point not held.	Controller defective.	Contact BINDER service.
	Pt 100 sensor defective.	
	Semiconductor relay defective	Calibrate and adjust controller.
Chamber doesn't heat up. LED (3a) "Heating active" lit.	Heating element defective.	Contact BINDER service.
	Semiconductor relay defective.	
Chamber doesn't heat up. LED (3a) "Heating active" not lit. Controller display working.	Semiconductor relay defective.	Contact BINDER service.
	Controller defective.	
Chamber permanently turned off. Red indicator lamp of safety device class 2 (2a) lit.	Safety device class 2 has turned off the oven.	Let cool down the oven and press down RESET button. Check temperature set-point and setting of safety device (chap. 14.1). If appropriate, select suitable limit value.
	Safety device class 2 defective.	Contact BINDER service.
Chamber permanently turned off.	No power supply.	Check connection to power supply.
	Wrong voltage.	Check power supply for voltage of 115V or 230V.
	Chamber fuse has responded.	Check chamber fuse and replace it if appropriate. if it responds again, contact BINDER service.
	Controller defective.	Contact BINDER service.
Deviations from the indicated heating-up times.	Oven fully loaded.	Charge the oven less or consider longer heating-up times.
Controller		
Program duration longer than programmed.	Inappropriate tolerances have been programmed.	For rapid transition phases, do NOT program tolerance limits in order to allow maximum heating speed.
Program stops one section too early.	Program line is incomplete.	When programming, define the end value of the desired cycle by adding an additional section with a section time of at least one minute.
Programs have been deleted.	Change from 2 programs to 1 program or vice-versa	When changing, ensure that the programs are no more needed.
The controller returns to Normal Display from any level.	No button was hit for more than 120 sec.	Repeat entries, enter the values rapidly.
Message RANGE ERROR CH1 in Normal Display in Display 2	Sensor rupture between sensor and controller	Contact BINDER service.
Ramp temperature transitions are only realized as steps.	Set-point programming type set to "Step" in the User level (chap. 10).	Set the set-point programming type to setting "Ramp" in the User level (chap. 10).



Have repairs performed only by experts authorized by BINDER. Repaired chambers must comply with the quality standard specified by BINDER.

19. Technical description

19.1 Factory calibration and adjustment

This chamber was calibrated and adjusted in factory. Calibration and adjustment were performed using standardized test instructions, according to the QM DIN EN ISO 9001 system applied by BINDER (certified since December 1996 by TÜV CERT). All test equipment used is subject to the administration of measurement and test equipment that is also constituent part of the BINDER QM DIN EN ISO 9001 systems. They are controlled and calibrated to a DKD-Standard at regular intervals.

19.2 Over current protection

Single-phase devices are protected by a miniature fuse against over current, accessible from the outside. The miniature fuse is located at the rear of the chamber below the strain relief of the power cord. The fuse holder is equipped with a fuse clip 5 mm x 20 mm (cUL-Version 6.3 mm x 32 mm). The fuse may be replaced only with a substitute of the same ratings. Refer to the technical data of the respective device type.

Three-phase devices are equipped with internal fuses not accessible from outside. If these fuses are blown, please inform an electronic engineer or BINDER service.

19.3 Definition of usable space

The usable volume illustrated below is calculated as follows:

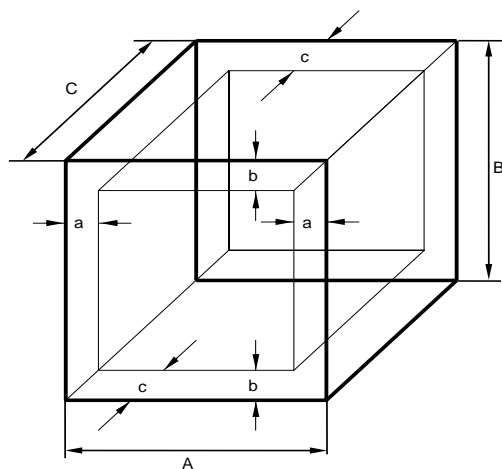

A, B, C = internal dimensions (W, H, D)

a, b, c = wall separation

$$a = 0.1 * A$$

$$b = 0.1 * B$$

$$c = 0.1 * C$$

$$V_{USE} = (A - 2 * a) * (B - 2 * b) * (C - 2 * c)$$

Figure 14: Determination of the usable volume

The technical data refers to the so defined usable space.



Do NOT place samples outside this usable volume.

Do NOT load this volume by more than half to enable sufficient airflow inside the chamber.

Do NOT divide the usable volume into separate parts with large area samples.

Do NOT place samples too close to each other in order to permit circulation between them and thus obtain a homogenous distribution of temperature and humidity.

19.4 Technical data

Chamber size		53	115	240	400	720	
Exterior dimensions							
Width, net	mm inch	635 25.00	835 32.87	1035 40.75	1235 48.62	1235 48.62	
Height, gross (incl. feet/castors)	mm inch	620 24.41	705 27.76	825 32.48	1025 40.35	1530 60.24	
Depth, net	mm inch	575 22.64	645 25.39	745 29.33	765 30.12	865 34.06	
Depth, gross (incl. door handle, instrument panel, and exhaust duct)	mm inch	680 26.77	750 29.53	850 33.46	870 34.25	970 38.19	
Wall clearance rear (minimum)	mm inch	100 3.94	100 3.94	100 3.94	100 3.94	100 3.94	
Wall clearance side (minimum)	mm inch	160 6.30	160 6.30	160 6.30	160 6.30	160 6.30	
Exhaust duct, outer diameter	mm inch	52 2.05	52 2.05	52 2.05	52 2.05	52 2.05	
Doors							
Number of doors		1	1	2	2	2	
Interior dimensions							
Width	mm inch	400 15.75	600 23.62	800 31.50	1000 39.37	1000 39.37	
Height	mm inch	400 15.75	480 18.90	600 23.62	800 31.50	1200 47.24	
Depth	mm inch	340 13.39	410 16.14	510 20.08	510 20.08	610 24.02	
Interior volume	l cu.ft.	53 1.9	115 4.1	240 8.6	400 14.3	720 25.7	
Steam space volume	l cu.ft.	77 2.72	158 5.58	308 10.88	498 17.60	869 30.71	
Racks							
Quantity of racks (regular)		2	2	2	2	2	
Quantity of racks (max.)		5	6	7	10	16	
Max. load per rack	Kg / lbs	15 / 33	20 / 44	30 / 66	35 / 77	45 / 99	
Permitted total load	Kg / lbs	40 / 88	50 / 110	70 / 155	90 / 199	120 / 265	
Weight							
Weight (empty)	Kg / lbs	45 / 99	62 / 137	98 / 216	145 / 320	184 / 406	
Temperature data							
Temperature range, 5 °C above ambient up to	°C °F	300 572	300 572	300 572	300 572	300 572	
Temperature fluctuation	≤± K	0.3	0.3	0.3	0.3	0.3	
Temperature uniformity (variation)	at 70 °C	± K	0.8	0.7	0.8	1	1
	at 150 °C	± K	2	1.8	2	2.5	2
	at 300 °C	± K	3.7	3.9	4.3	4.8	5.5
Heating up time	to 70 °C	Min	6	7	12	18	25
	to 150 °C	Min	24	30	27	35	39
	to 250 °C	Min	45	49	50	60	65
Recovery time after door was open for 30 sec	at 70 °C	Min	2	2	2	2	2
	at 150 °C	Min	5	8	10	17	20
	at 300 °C	Min	10	15	16	21	24

Chamber size			53	115	240	400	720	
Ventilation data								
Air change	at 70 °C	x/h	59	29	19	17	11	
	at 150 °C	x/h	64	32	20	18	12	
	at 300 °C	x/h	53	26	18	16	10	
Electrical data (model versions FP053-230V, FP115-230V, FP240-230V, FP400-230V, FP720-230V)								
IP system of protection acc. to EN 60529			20	20	20	20	20	
Nominal voltage (+/-10%)	at 50 Hz power frequency	V	230	230	230	400	400	
	at 60 Hz power frequency	V	230	230	230	400	400	
Current type			1N~	1N~	1N~	3N~	3N~	
Nominal power			kW	1,20	1,60	2,70	3,40	5,00
Chamber fuse 5 x 20 mm 230V / time-lag (T)			10 A external	10 A external	--	--	--	
Chamber fuse 5 x 20 mm 230V / middle-time-lag (M)			--	--	16 A external	--	--	
Over-current release category B			--	--	--	3 x 16A internal	3 x 16A internal	
Power plug			shock proof plug			CEE plug 5 poles		
Installation category acc. to IEC 1010-1			II	II	II	II	II	
Pollution degree acc. to IEC 1010-1			2	2	2	2	2	
Different electrical data for FP-UL constructed for the USA and Canada (model versions FP053UL-120V, FP115UL-120V, FP240UL-120V, FP400UL-120V, FP720UL-120V)								
Nominal voltage (+/-10%) at 60 Hz power frequency		V	115	115	208	208	208	
Current type			1N~	1N~	3N~	3N~	3N~	
Power plug		NEMA	5-20P	5-20P	L21-20P	L21-20P	L21-20P	
Chamber fuse 6,3 x 32 mm / 250V / super-time-lag TT		A	16	16	16	16	20	
			external	external	3 x internal	3 x internal	3 x internal	
Installation category acc. to IEC 1010-1			II	II	II	II	II	
Pollution degree acc. to IEC 1010-1			2	2	2	2	2	
Environment-specific data								
Energy consumption	at 70 °C	Wh/h	145	230	370	520	570	
	at 150 °C	Wh/h	300	544	850	1200	1320	
	at 300 °C	Wh/h	720	1100	1400	2340	2600	

All technical data is specified for unloaded chambers with standard equipment at an ambient temperature of +22 °C +/- 3°C / 71.6 °F ± 5.4 °F and a power supply voltage fluctuation of ±10. Technical data is determined in accordance to BINDER Factory Standard Part 1:2015 following DIN 12880:2007.

All indications are average values, typical for chambers produced in series. We reserve the right to alter technical specifications at all times.



If the chamber is fully loaded, the specified heating up times may vary according to the load.

19.5 Equipment and options (extract)



To operate the chamber, use only original BINDER accessories or accessories from third-party suppliers authorized by BINDER. The user is responsible for any risk arising from using unauthorized accessories.

Chamber size	53	115	240	400	720
Regular equipment					
Multifunction program controller RD3 with digital display	●	●	●	●	●
Temperature safety device class 2 acc. to DIN 12880	●	●	●	●	●
Communication and printer interface RS 422	●	●	●	●	●
Rear exhaust duct, internal diameter 50 mm / 1.97 in with ventilation slide	●	●	●	●	●
Adjustable air change by means of rear exhaust duct (50 mm / 1.97 in) with ventilation flap and front ventilation slide	●	●	●	●	●
Four castors (2 lockable)	--	--	--	--	●
2 racks, chrome-plated	●	●	●	●	●
Options / accessories					
Access ports, various diameters, with silicone plug	○	○	○	○	○
Rack, chrome-plated or stainless steel	○	○	○	○	○
Perforated rack, stainless steel	○	○	○	○	○
Rack lockings (4 pieces)	○	○	○	○	○
Reinforced rack stainless steel, with 1 set of rack lockings	--	--	○	○	○
Reinforced inner chamber with 2 reinforced racks	--	--	○	○	○
Rubber pads for safe stacking (4 pieces)	○	○	○	--	--
Temperature safety device class 3.1 acc. to DIN 12880:2007	○	○	○	○	○
Door(s) with window and interior lightning	○	○	○	○	○
Lockable door	○	○	○	○	○
FKM door gasket (temperature resistant up to 200 °C)	○	○	○	○	○
HEPA Fresh air filter, class H 14 (DIN EN 1822)	○	○	○	○	○
Measurement of air change rate acc. to ASTM D5374	○	○	○	○	○
Increased air change by stronger fan	○	○	○	○	○
Mostly gas-tight version	○	○	--	--	--
Inert gas connection (gas inlet and outlet) with mostly gas-tight version	○	○	--	--	--
Additional measuring channel for digital object temperature indicator with flexible temperature sensor Pt 100	○	○	○	○	○
Analog output 4-20 mA for temperature with 6 pole DIN socket, DIN plug included	○	○	○	○	○
Zero-voltage relay outputs via DIN socket 6 poles	○	○	○	○	○
Data Logger Kit T 350	○	○	○	○	○
Temperature calibration including certificate	○	○	○	○	○
Spatial temperature measurement including certificate	○	○	○	○	○
Qualification folder	○	○	○	○	○
Chamber acc. to cUL standard in 115V 1N~60Hz	○	○	--	--	--
Chamber acc. to cUL standard in 208 V 3N~60Hz	--	--	□	○	○
Base on castors	○	○	○	○	○
Sturdy trolley, castors with locking brakes	○	○	○	○	○

Legend: ● Standard equipment ○ Optional -- Not available

19.6 Accessories and spare parts (extract)



BINDER GmbH is only responsible for the safety features of the chamber provided skilled electricians or qualified personnel authorized by BINDER perform all maintenance and repair, and if components relating to chamber safety are replaced in the event of failure with original spare parts. The user is responsible for any risk arising from using unauthorized accessories.

Chamber size	53	115	240	400	720
Description	Art. No.				
Rack, chrome-plated	6004-0002	6004-0003	6004-0004	6004-0005	6004-0006
Rack, stainless steel	6004-0007	6004-0008	6004-0009	6004-0011	6004-0010
Perforated rack, stainless steel	6004-0029	6004-0030	6004-0031	6004-0032	6004-0033
Door gasket silicone	6005-0095	6005-0096	6005-0097	6005-0069	6005-0099
Door gasket made of FKM (temperature resistant up to 200 °C)	8012-0494	8012-0495	8012-0496	8012-0497	8012-0498
Stable table on wheels with castors and locking brakes	9051-0018	9051-0018	9051-0019	9051-0019	--
Rubber pads for safe stacking (4 pieces)	8012-0001	8012-0001	8012-0001	--	--
Chamber fuse 5x20mm / 250V / 10Amp time lag (T)	5006-0012	5006-0012	--	--	--
Chamber fuse 5x20mm / 250V / 16Amp semi time lag (M)	--	--	5006-0013	--	--

Description	Art. No.
Rack lockings (4 pieces)	8012-0531
Data logger Kit T350	8012-0714
Data logger software, including converter-cable	8012-0821
HEPA Fresh air filter, class EU 14H 14 (DIN EN 1822:2009)	8012-0076
Neutral cleaning agent, 1 kg	1002-0016

For information on components not listed here, please contact BINDER Service.

Validation service	Art. No.
Qualification folder IQ-OQ	8012-0865
Qualification folder IQ-OQ-PQ	8012-0945
Execution of IQ-OQ	DL410200
Execution of IQ-OQ-PQ	DL440500

Calibration service	Art. No.
Calibration of temperature including certificate (1 measuring point)	DL300101
Spatial temperature measurement including certificate (9 measuring points)	DL300109
Spatial temperature measurement including certificate (18 measuring points)	DL300118
Spatial temperature measurement including certificate (27 measuring points)	DL300127
Measurement of air change rate acc. to ASTM D5374	DL005026

19.7 Dimensions FP 53

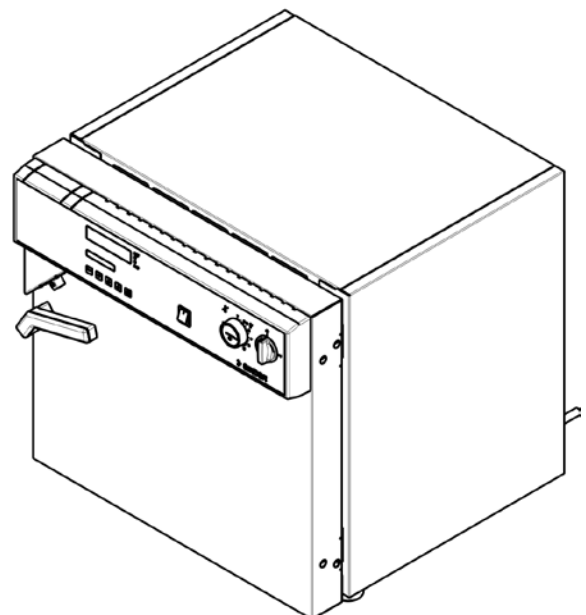
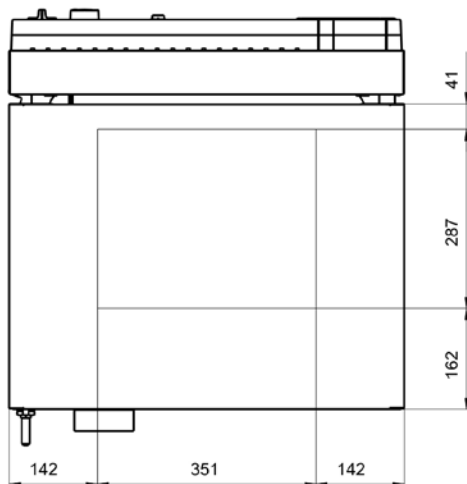
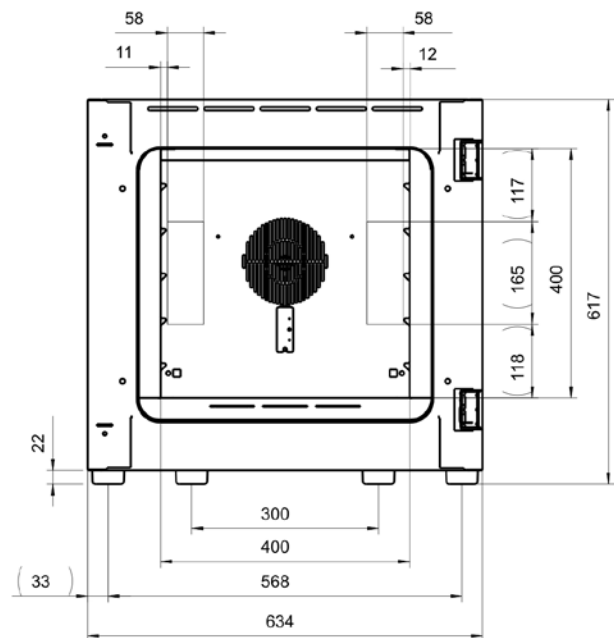
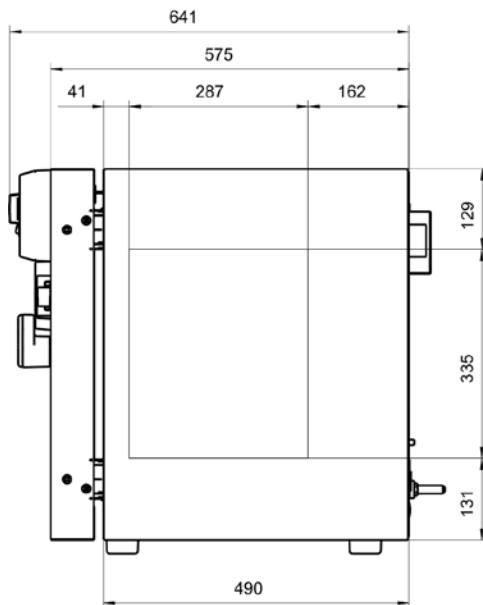
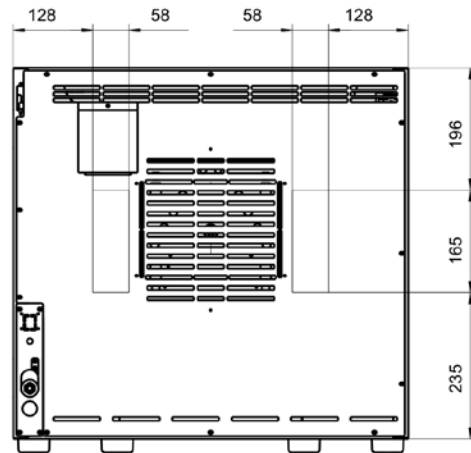
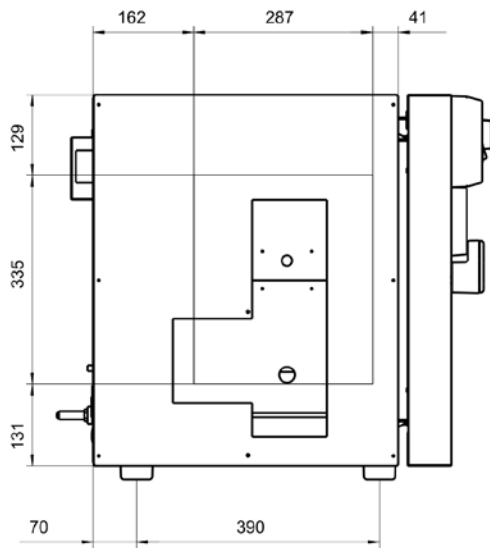

19.8 Dimensions FP 115

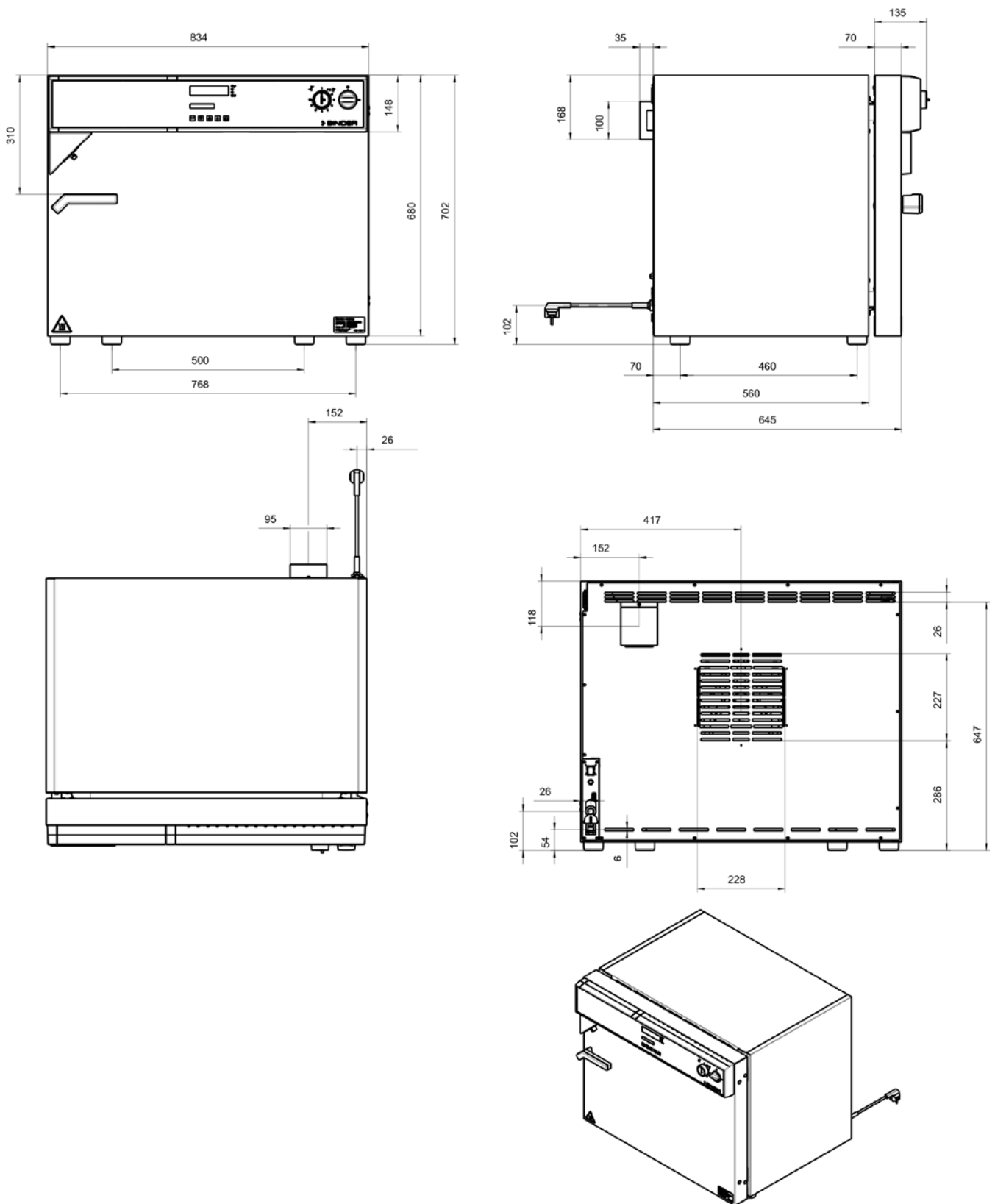

19.9 Dimensions FP 240

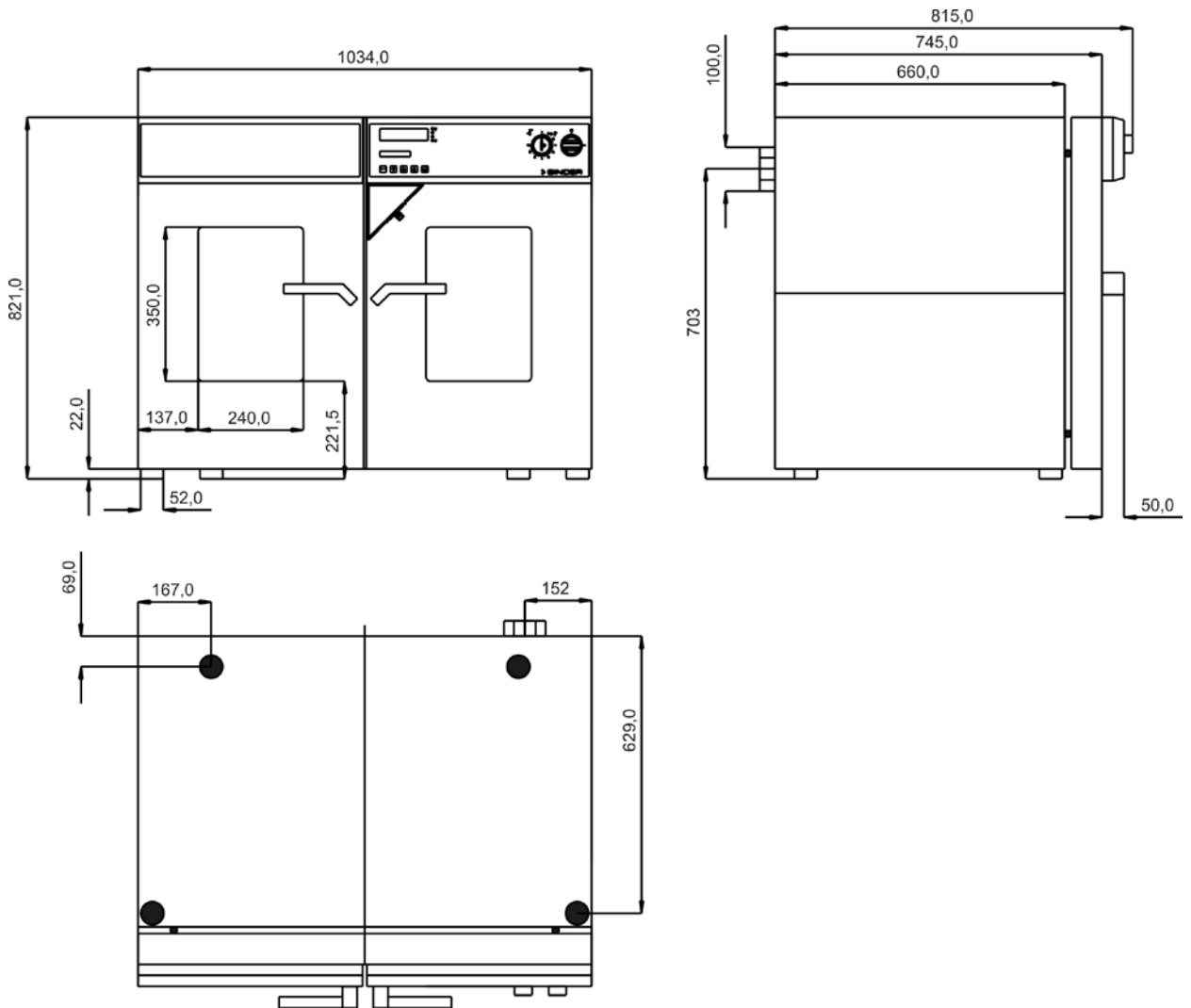

19.10 Dimensions FP 400

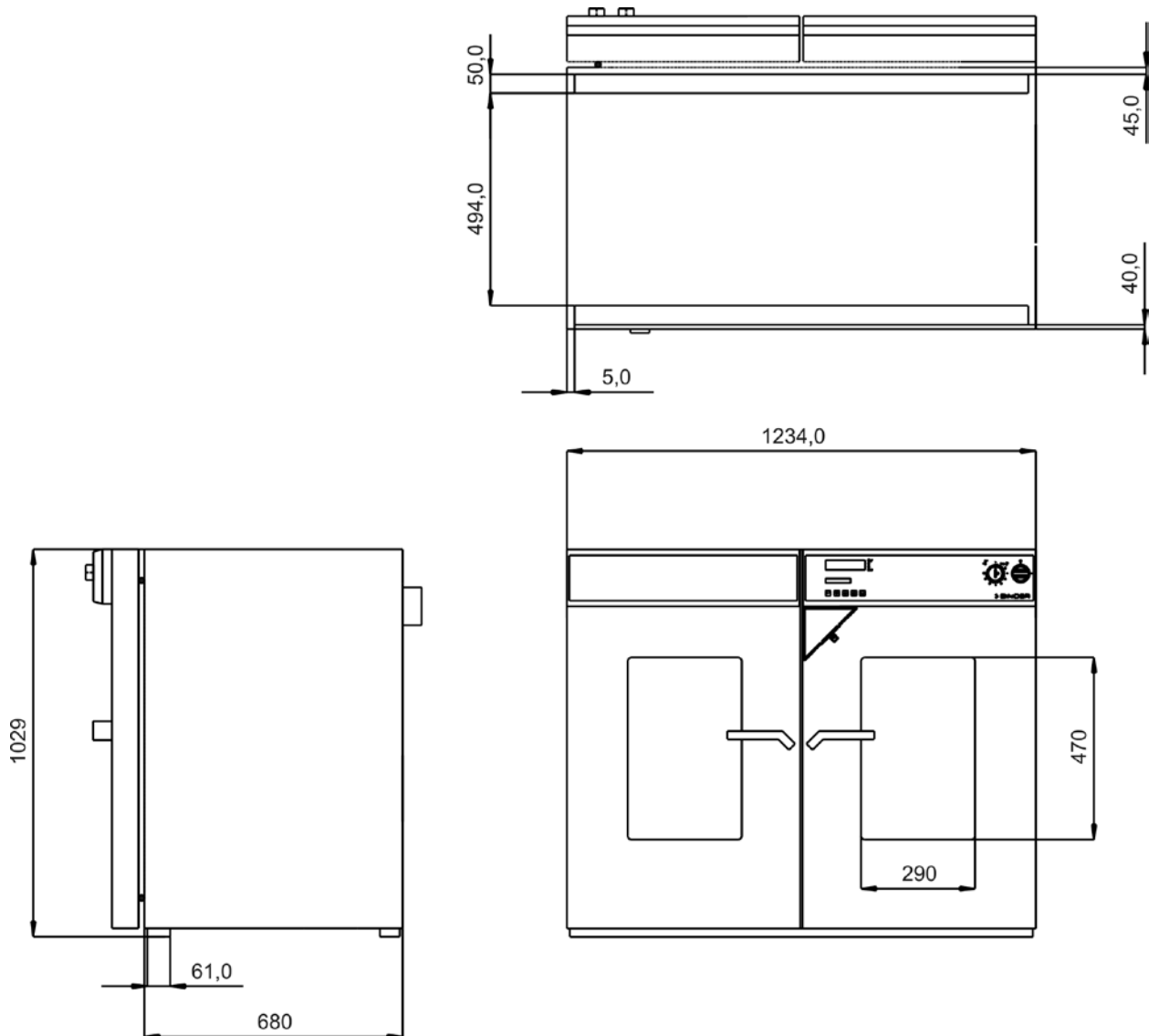

19.11 Dimensions FP 720

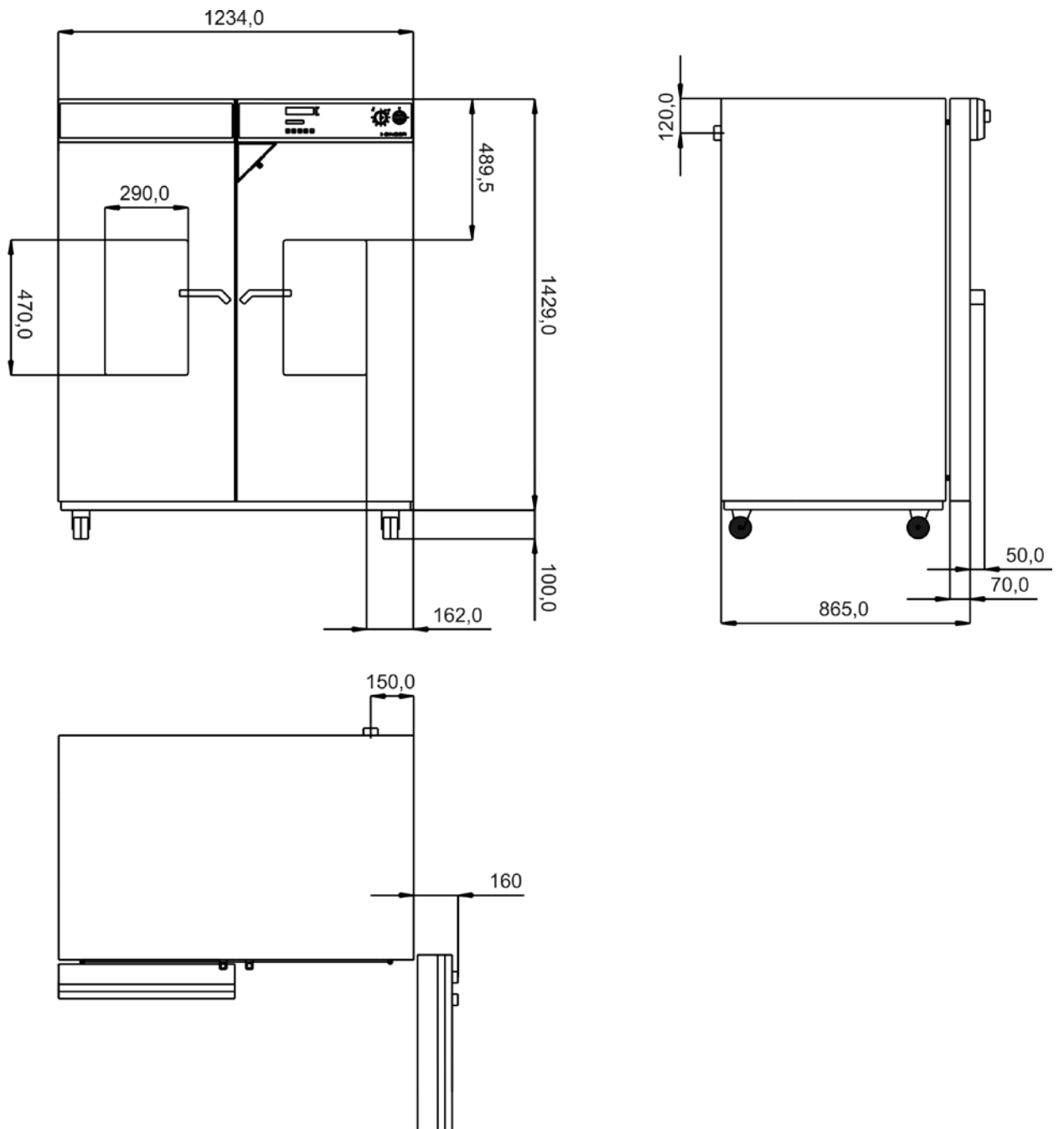

20. EU Declaration of Conformity



Best conditions for your success

	EU-Konformitätserklärung / EU Declaration of Conformity / Déclaration de conformité UE / Declaración de conformidad UE / Dichiarazione di conformità UE / Декларация соответствия EU
Hersteller / Manufacturer / Fabricant / Fabricante / Fabbricante / Производитель	BINDER GmbH
Anschrift / Address / Adresse / Dirección / Indirizzo / Адрес	Im Mittleren Ösch 5, 78532 Tuttlingen, Germany
Produkt / Product / Produit / Producto / Prodotto / Продукт	Trocken- und Wärmeschränke mit Umluft Drying and heating ovens with forced convection Etuves de chauffage et de séchage à convection forcée Estufas de secado y calentamiento con convección forzada Stufe per essiccazione e riscaldamento a convezione forzata Сушильные и сухожаровые шкафы с принудительной конвекцией
Typenbezeichnung / Type / Type / Tipo / Tipo / Тип	FP 53, FP 115, FP 240, FP 400, FP 720

Das oben beschriebene Produkt ist konform mit folgenden EU-Richtlinien:
The product described above is in conformity with the following EU Directives:
Le produit décrit ci-dessus est conforme aux directives UE suivantes:
El producto descrito arriba cumple con las siguientes directivas de la UE:
Il prodotto sopra descritto è conforme alle seguenti direttive UE:
Продукты, указанные выше, полностью соответствуют следующим EU руководствам:

- **2014/35/EU**
Niederspannungsrichtlinie 2014/35/EU / Low voltage directive 2014/35/EU / Directive basse tension 2014/35/UE / Directiva sobre baja tensión 2014/35/UE / Direttiva Bassa tensione 2014/35/UE / Директива по низкому напряжению 2014/35/EU
- **2014/30/EU**
EMV-Richtlinie 2014/30/EU / EMC Directive 2014/30/EU / Directive CEM 2014/30/UE / Directiva CEM 2014/30/UE / Direttiva EMC 2014/30/UE / Директива ЭМС 2014/30/EU
- **2011/65/EU**
RoHS-Richtlinie 2011/65/EU / RoHS Directive 2011/65/EU / Directive RoHS 2011/65/UE / Directiva RoHS 2011/65/UE / Direttiva RoHS 2011/65/UE / Директива RoHS 2011/65/EU

Die oben beschriebenen Produkte tragen entsprechend die Kennzeichnung CE.
The products described above, corresponding to this, bear the CE-mark.
Les produits décrits ci-dessus, en correspondance, portent l'indication CE.
Los productos descritos arriba, en conformidad, llevan la indicación CE.
I prodotti sopra descritti, conformi a quanto sopra, portano il marchio CE.
Данные продукты в соответствии с изложенным выше маркированы знаком CE.

1 / 2

BINDER GmbH Postfach 102 D-78502 Tuttlingen **Address:** BINDER GmbH Im Mittleren Ösch 5 78532 Tuttlingen Germany
Contact: Phone: +49 (0) 74 62 / 20 05 - 0 | Fax: +49 (0) 74 62 / 20 05 - 100 | info@binder-world.com | www.binder-world.com
Managing Director: Dipl.-Ing. Peter M. Binder | District court Stuttgart, HRB 727150 | Company head office: Tuttlingen Germany
Payment Details: Kreissparkasse Tuttlingen Account no.: 2266 BAN: 643 500 70 | IBAN-Code: DE05643 500700 00002266 | SWIFT-Code: SOLA DE S1TUT
 \$-Account no. 2202 611 55 | IBAN-Code: DE7464350070 0220 261155 | SWIFT-Code: SOLA DE S1TUT
 Deutsche Bank Tuttlingen Account no.: 2 138 709 BAN: 653 700 75 | IBAN-Code: DE56653 70075 0213870900 | SWIFT-Code: DEUT DE SS603
 Recycling of old equipment according to WEEE-Reg.-no. DE 37004983

Die oben beschriebenen Produkte sind konform mit folgenden harmonisierten Normen:
 The products described above are in conformity with the following harmonized standards:
 Les produits décrits ci-dessus sont conformes aux normes harmonisées suivantes:
 Los productos descritos arriba cumplen con las siguientes normas:
 I prodotti sopra descritti sono conformi alle seguenti normative armonizzate:
 Продукты, указанные выше, полностью соответствуют следующим стандартам:

Sicherheit / Safety / Sécurité / Seguridad / Sicurezza / Нормативы по безопасности
<ul style="list-style-type: none"> • EN 61010-1:2010 • EN 61010-2-010:2014
EMV / EMC / CEM / CEM / EMC / ЭМС
<ul style="list-style-type: none"> • EN 61326-1:2013
RoHS
<ul style="list-style-type: none"> • EN 50581:2012

78532 Tuttlingen, 03.07.2017

BINDER GmbH



P. M. Binder
 Geschäftsführender Gesellschafter
 Managing Director
 Directeur général
 Director general
 Direttore Generale
 Генеральный Директор



J. Bollaender
 Leiter F & E
 Director R & D
 Chef de service R&D
 Responsable I & D
 Direttore R & D
 Глава департамента R&D

2 / 2

BINDER GmbH Postfach 102 D-78502 Tuttlingen **Address:** BINDER GmbH Im Mittleren Ösch 5 78532 Tuttlingen Germany
Contact: Phone: +49 (0) 74 62 / 20 05 - 0 | Fax: +49 (0) 74 62 / 20 05 - 100 | info@binder-world.com | www.binder-world.com
Managing Director: Dipl.-Ing. Peter M. Binder | District court Stuttgart, HRB 727150 | Company head office: Tuttlingen Germany
Payment Details: Kreissparkasse Tuttlingen Account no.: 2266 BAN: 643 500 70 | IBAN-Code: DE05643 500700 000002266 | SWIFT-Code: SOLA DE S1TUT
 \$-Account no. 2202 611 55 | IBAN-Code: DE7464350070 0220 261155 | SWIFT-Code: SOLA DE S1TUT
 Deutsche Bank Tuttlingen Account no.: 2 138 709 BAN: 653 700 75 | IBAN-Code: DE56653 70075 0213870900 | SWIFT-Code: DEUT DE SS603
 Recycling of old equipment according to WEEE-Reg.-no. DE 37004983

21. Product registration

Online Product Registration

Register your BINDER now!

www.binder-world.com/register

The registration is free and takes just a few seconds

Advantages:

- ▶ Short response times if service is needed
- ▶ Fair prices when relocating or installing equipment
- ▶ Calibration as required at no charge in case of recalls
- ▶ Free information on news, product upgrades and accessories

Easy registered in 3 steps:



1. List serial number here:

-

2. Go online: www.binder-world.com/register

3. Register serial number

22. Contamination clearance certificate

22.1 For chambers located outside USA and Canada

Declaration with regard to safety and health

Erklärung zur Sicherheit and gesundheitlichen Unbedenklichkeit

The German Ordinance on Hazardous Substances (GefStofV), and the regulations regarding safety at the workplace, require that this form be filled out for all products that are returned to us, so that the safety and health of our employees can be warranted.

Die Sicherheit und Gesundheit unserer Mitarbeiter, die Gefahrstoffverordnung GefStofV und die Vorschriften zur Sicherheit am Arbeitsplatz machen es erforderlich, dass dieses Formblatt für alle Produkte, die an uns zurückgeschickt wird.

	<p>In the absence of a completely filled out form, a repair is not possible. Ohne Vorliegen des vollständig ausgefüllten Formblattes ist eine Reparatur nicht möglich.</p>
---	--

- A completely filled out form should be transmitted by Fax (+49 (0) 7462 2005 93555) or by letter in advance to us, so that this information is available before the equipment/component part arrives. A second copy of this form should accompany the equipment/component part. Eventually the carrier should be informed.

Eine vollständig ausgefüllte Kopie dieses Formblattes soll per Telefax (Nr. +49 (0) 7462 2005 93555) oder Brief vorab an uns gesandt werden, so dass die Information vorliegt, bevor das Gerät/Bauteil eintrifft. Eine weitere Kopie soll dem Gerät/Bauteil beigefügt sein. Ggf. ist auch die Spedition zu informieren.

- Incomplete information or non-conformity with this procedure will inevitably lead to substantial delays in processing. We hope you will have understanding for this measure, which lies outside of our area of influence, and that you will help us to speed up this procedure.

Unvollständige Angaben oder Nichteinhalten dieses Ablaufs führen zwangsläufig zu beträchtlichen Verzögerungen in der Abwicklung. Bitte haben Sie Verständnis für Maßnahmen, die außerhalb unserer Einflussmöglichkeiten liegen und helfen Sie mit, den Ablauf beschleunigen.

- **Please fill out this form completely.**

Bitte unbedingt vollständig ausfüllen!

1.	Unit/ component part / type: / Gerät / Bauteil / Typ:
2.	Serial No./ Serien-Nr.:
3.	Details about utilized substances / biological substances / Einzelheiten über die eingesetzten Substanzen/biologische Materialien:
3.1	Designations / Bezeichnungen:
a)	_____
b)	_____
c)	_____
3.2	Safety measures required for handling these substances / Vorsichtsmaßnahmen beim Umgang mit diesen Stoffen:
a)	_____
b)	_____
c)	_____

3.3 Measures to be taken in case of skin contact or release into the atmosphere / Maßnahmen bei Personenkontakt oder Freisetzung:
a) _____
b) _____
c) _____
d) _____
3.4 Other important information that must be taken into account / Weitere zu beachtende und wichtige Informationen:
a) _____
b) _____
c) _____
4. Declaration on the risk of these substances (please checkmark the applicable items) / Erklärung zur Gefährlichkeit der Stoffe (bitte Zutreffendes ankreuzen) :
<input type="checkbox"/> 4.1 For non toxic, non radioactive, biologically harmless materials / für nicht giftige, nicht radioaktive, biologisch ungefährliche Stoffe:
We herewith guarantee that the above-mentioned unit / component part... / Wir versichern, dass o.g. Gerät/Bauteil...
<input type="checkbox"/> Has not been exposed to or contains any toxic or otherwise hazardous substances / weder giftige noch sonstige gefährliche Stoffe enthält oder solche anhaften.
<input type="checkbox"/> That eventually generated reaction products are non-toxic and also do not represent a hazard / auch evtl. entstandene Reaktionsprodukte weder giftig sind noch sonst eine Gefährdung darstellen.
<input type="checkbox"/> Eventual residues of hazardous substances have been removed / evtl. Rückstände von Gefahrstoffen entfernt wurden.
<input type="checkbox"/> 4.2 For toxic, radioactive, biologically harmful or hazardous substances, or any other hazardous materials / für giftige, radioaktive, biologisch bedenkliche bzw. gefährliche Stoffe oder anderweitig gefährliche Stoffe.
We herewith guarantee that ... / Wir versichern, dass ...
<input type="checkbox"/> The hazardous substances, which have come into contact with the above-mentioned equipment/component part, have been completely listed under item 3.1 and that all information in this regard is complete / die gefährlichen Stoffe, die mit dem o.g. Gerät/Bauteil in Kontakt kamen, in 3.1 aufgelistet sind und alle Angaben vollständig sind.
<input type="checkbox"/> That the unit /component part has not been in contact with radioactivity / das Gerät/Bauteil nicht mit Radioaktivität in Berührung kam
5. Kind of transport / transporter / Transportweg/Spediteur:
Transport by (means and name of transport company, etc.) / Versendung durch (Name Spediteur o.ä.)

Date of dispatch to BINDER GmbH / Tag der Absendung an BINDER GmbH:

We herewith declare that the following measures have been taken / Wir erklären, dass folgende Maßnahmen getroffen wurden:

- Hazardous substances were removed from the unit / component part, so that no hazard exists for corresponding persons in the handling or repair of these items / das Gerät/Bauteil wurde von Gefahrstoffen befreit, so dass bei Handhabung/Reparaturen für die betreffenden Person keinerlei Gefährdung besteht
- The unit was securely packaged and properly identified / das Gerät wurde sicher verpackt und vollständig gekennzeichnet.
- Information about the hazardousness of the shipment (if required) has been provided to the transporter / der Spediteur wurde (falls vorgeschrieben) über die Gefährlichkeit der Sendung informiert.

We herewith commit ourselves and guarantee that we will indemnify BINDER GmbH for all damages that are a consequence of incomplete or incorrect information provided by us, and that we will exempt BINDER GmbH from eventual damage claims by third parties./ Wir versichern, dass wir gegenüber BINDER für jeden Schaden, der durch unvollständige und unrichtige Angaben entsteht, haften und BINDER gegen eventuell entstehende Schadenansprüche Dritter freistellen.

We are aware that, in accordance with Article 823 of the German Civil Code (BGB), we are directly liable with regard to third parties, in this instance especially the employees of BINDER GmbH, who have been entrusted with the handling / repair of the unit / component. / Es ist uns bekannt, dass wir gegenüber Dritten – hier insbesondere mit der Handhabung/Reparatur des Geräts/des Bauteils betraute Mitarbeiter der Firma BINDER - gemäß §823 BGB direkt haften

Name: _____

Position: _____

Date / Datum: _____

Signature / Unterschrift: _____

Company stamp / Firmenstempel:



Equipment that is returned to the factory for repair must be accompanied by a completely filled out contamination clearance certificate. For service and maintenance works on site, such a contamination clearance certificate must be submitted to the service technician before the start of the works. No repair or maintenance of the equipment is possible, without a properly filled out contamination clearance certificate.

22.2 For chambers in USA and Canada

Product Return Authorization Request

Please complete this form and the Customer Decontamination Declaration (next 2 pages) and attach the required pictures. E-mail to: IDL_SalesOrderProcessing_USA@binder-world.com

After we have received and reviewed the complete information we will decide on the issue of a RMA number. Please be aware that size specifications, voltage specifications as well as performance specifications are available on the internet at www.binder-world.us at any time.

Take notice of shipping laws and regulations.

	Please fill:	
Reason for return request	<input type="radio"/> Duplicate order	
	<input type="radio"/> Duplicate shipment	
	<input type="radio"/> Demo	<i>Page one completed by sales</i>
	<input type="radio"/> Power Plug / Voltage	115V / 230 V / 208 V / 240V
	<input type="radio"/> Size does not fit space	
	<input type="radio"/> Transport Damage	Shock watch tripped? (<i>pictures</i>)
	<input type="radio"/> Other (specify below)	

Is there a replacement PO?	<input type="radio"/> Yes <input type="radio"/> No	
<i>If yes -> PO #</i>		
<i>If yes -> Date PO placed</i>		
Purchase order number		
BINDER model number		
BINDER serial number		
Date unit was received		
Was the unit unboxed?	<input type="radio"/> Yes <input type="radio"/> No	
Was the unit plugged in?	<input type="radio"/> Yes <input type="radio"/> No	
Was the unit in operation?	<input type="radio"/> Yes <input type="radio"/> No	
<i>Pictures of unit attached?</i>	<input type="radio"/> Yes <input type="radio"/> No	Pictures have to be attached!
<i>Pictures of Packaging attached?</i>	<input type="radio"/> Yes <input type="radio"/> No	

	Customer Contact Information	Distributor Contact Information
Name		
Company		
Address		
Phone		
E-mail		

Customer (End User) Decontamination Declaration

Health and Hazard Safety declaration

To protect the health of our employees and the safety at the workplace, we require that this form is completed by the user for all products and parts that are returned to us. (Distributors or Service Organizations cannot sign this form)

	<p>NO RMA number will be issued without a completed form. Products or parts returned to our NY warehouse without a RMA number will be refused at the dock.</p>
---	--

A second copy of the completed form must be attached to the outside of the shipping box.

<p>1. Unit/ component part / type:</p>
<p>2. Serial No.</p>
<p>3. List any exposure to hazardous liquids, gasses or substances and radioactive material</p>
<p>3.1 List with MSDS sheets attached where available or needed (if there is not enough space available below, please attach a page):</p> <p>a) _____</p> <p>b) _____</p> <p>c) _____</p>
<p>3.2 Safety measures required for handling the list under 3.1</p> <p>a) _____</p> <p>b) _____</p> <p>c) _____</p>
<p>3.3 Measures to be taken in case of skin contact or release into the atmosphere:</p> <p>a) _____</p> <p>b) _____</p> <p>c) _____</p> <p>d) _____</p>
<p>3.4 Other important information that must be considered:</p> <p>a) _____</p> <p>b) _____</p> <p>c) _____</p>

4. Declaration of Decontamination

For toxic, radioactive, biologically and chemically harmful or hazardous substances, or any other hazardous materials.

We hereby guarantee that

- 4.1 Any hazardous substances, which have come into contact with the above-mentioned equipment / component part, have been completely listed under item 3.1 and that all information in this regard is complete.
- 4.2 That the unit /component part has not been in contact with radioactivity
- 4.3 Any Hazardous substances were removed from the unit / component part, so that no hazard exists for a persons in the shipping, handling or repair of these returned unit
- 4.4 The unit was securely packaged in the original undamaged packaging and properly identified on the outside of the packaging material with the unit designation, the RMA number and a copy of this declaration.
- 4.5 Shipping laws and regulations have not been violated.

I hereby commit and guarantee that we will indemnify BINDER Inc. for all damages that are a consequence of incomplete or incorrect information provided by us, and that we will indemnify and hold harmless BINDER Inc. from eventual damage claims by third parties.

Name: _____

Position: _____

Company: _____

Address: _____

Phone #: _____

Email: _____

Date: _____

Signature: _____



Equipment returned to the NY warehouse for repair must be accompanied by a completed customer decontamination declaration. For service and maintenance works on site, such a customer decontamination declaration must be submitted to the service technician before the start of work. No repair or maintenance of the equipment is possible without a completed form.

